

International Energy Agency, EBC Annex 58

# Reliable building energy performance characterisation based on full scale dynamic measurements

**Report of Subtask 1a: Inventory of full scale test facilities for evaluation of building energy performances**

Arnold Janssens





International Energy Agency, EBC Annex 58

# **Reliable building energy performance characterisation based on full scale dynamic measurements**

---

## **Report of Subtask 1a: Inventory of full scale test facilities for evaluation of building energy performances**

### **Authors**

Ghent University, Ghent, Belgium ([www.ugent.be](http://www.ugent.be))

Arnold Janssens

With contributions from:

Different institutes through test facility descriptions

Reviewed by:

Ingo Heusler– Fraunhofer-Institut für Bauphysik

Dirk Saelens – KU Leuven

© Copyright KU Leuven, Belgium 2016

All property rights, including copyright, are vested in KU Leuven, Belgium, Operating Agent for EBC Annex 58, on behalf of the Contracting Parties of the International Energy Agency Implementing Agreement for a Programme of Research and Development on Energy in Buildings and Communities. In particular, no part of this publication may be reproduced, stored in a retrieval system or transmitted in any form or by any means, electronic, mechanical, photocopying, recording or otherwise, without the prior written permission of KU Leuven.

Published by KU Leuven, Belgium

Disclaimer Notice: This publication has been compiled with reasonable skill and care. However, neither KU Leuven nor the EBC Contracting Parties (of the International Energy Agency Implementing Agreement for a Programme of Research and Development on Energy in Buildings and Communities) make any representation as to the adequacy or accuracy of the information contained herein, or as to its suitability for any particular application, and accept no responsibility or liability arising out of the use of this publication. The information contained herein does not supersede the requirements given in any national codes, regulations or standards, and should not be regarded as a substitute for the need to obtain specific professional advice for any particular application.

ISBN: 9789460189906

Participating countries in EBC:

Australia, Austria, Belgium, Canada, P.R. China, Czech Republic, Denmark, Finland, France, Germany, Greece, Ireland, Italy, Japan, Republic of Korea, the Netherlands, New Zealand, Norway, Poland, Portugal, Spain, Sweden, Switzerland, Turkey, United Kingdom and the United States of America.

Additional copies of this report may be obtained from:

[www.iea-ebc.org](http://www.iea-ebc.org)

[essu@iea-ebc.org](mailto:essu@iea-ebc.org)

*cover picture: Tailored heating experiment performed for one of the industrial partners of the Annex 58-project to determine the overall heat loss coefficient of a newly built dwelling based on on-site measured data. (source: Geert Bauwens, KU Leuven)*

# Preface

## The International Energy Agency

The International Energy Agency (IEA) was established in 1974 within the framework of the Organisation for Economic Co-operation and Development (OECD) to implement an international energy programme. A basic aim of the IEA is to foster international co-operation among the 29 IEA participating countries and to increase energy security through energy research, development and demonstration in the fields of technologies for energy efficiency and renewable energy sources.

## The IEA Energy in Buildings and Communities Programme

The IEA co-ordinates international energy research and development (R&D) activities through a comprehensive portfolio of Technology Collaboration Programmes. The mission of the Energy in Buildings and Communities (EBC) Programme is to develop and facilitate the integration of technologies and processes for energy efficiency and conservation into healthy, low emission, and sustainable buildings and communities, through innovation and research. (Until March 2013, the IEA-EBC Programme was known as the Energy in Buildings and Community Systems Programme, ECBCS.)

The research and development strategies of the IEA-EBC Programme are derived from research drivers, national programmes within IEA countries, and the IEA Future Buildings Forum Think Tank Workshops. The research and development (R&D) strategies of IEA-EBC aim to exploit technological opportunities to save energy in the buildings sector, and to remove technical obstacles to market penetration of new energy efficient technologies. The R&D strategies apply to residential, commercial, office buildings and community systems, and will impact the building industry in five focus areas for R&D activities:

- Integrated planning and building design
- Building energy systems
- Building envelope
- Community scale methods
- Real building energy use

## The Executive Committee

Overall control of the IEA-EBC Programme is maintained by an Executive Committee, which not only monitors existing projects, but also identifies new strategic areas in which collaborative efforts may be beneficial. As the Programme is based on a contract with the IEA, the projects are legally established as Annexes to the IEA-EBC Implementing Agreement. At the present time, the following projects have been initiated by the IEA-EBC Executive Committee, with completed projects identified by (\*):

- Annex 1: Load Energy Determination of Buildings (\*)
- Annex 2: Ekistics and Advanced Community Energy Systems (\*)
- Annex 3: Energy Conservation in Residential Buildings (\*)
- Annex 4: Glasgow Commercial Building Monitoring (\*)
- Annex 5: Air Infiltration and Ventilation Centre
- Annex 6: Energy Systems and Design of Communities (\*)
- Annex 7: Local Government Energy Planning (\*)
- Annex 8: Inhabitants Behaviour with Regard to Ventilation (\*)
- Annex 9: Minimum Ventilation Rates (\*)
- Annex 10: Building HVAC System Simulation (\*)
- Annex 11: Energy Auditing (\*)
- Annex 12: Windows and Fenestration (\*)
- Annex 13: Energy Management in Hospitals (\*)
- Annex 14: Condensation and Energy (\*)
- Annex 15: Energy Efficiency in Schools (\*)

- Annex 16: BEMS 1- User Interfaces and System Integration (\*)
- Annex 17: BEMS 2- Evaluation and Emulation Techniques (\*)
- Annex 18: Demand Controlled Ventilation Systems (\*)
- Annex 19: Low Slope Roof Systems (\*)
- Annex 20: Air Flow Patterns within Buildings (\*)
- Annex 21: Thermal Modelling (\*)
- Annex 22: Energy Efficient Communities (\*)
- Annex 23: Multi Zone Air Flow Modelling (COMIS) (\*)
- Annex 24: Heat, Air and Moisture Transfer in Envelopes (\*)
- Annex 25: Real time HVAC Simulation (\*)
- Annex 26: Energy Efficient Ventilation of Large Enclosures (\*)
- Annex 27: Evaluation and Demonstration of Domestic Ventilation Systems (\*)
- Annex 28: Low Energy Cooling Systems (\*)
- Annex 29: Daylight in Buildings (\*)
- Annex 30: Bringing Simulation to Application (\*)
- Annex 31: Energy-Related Environmental Impact of Buildings (\*)
- Annex 32: Integral Building Envelope Performance Assessment (\*)
- Annex 33: Advanced Local Energy Planning (\*)
- Annex 34: Computer-Aided Evaluation of HVAC System Performance (\*)
- Annex 35: Design of Energy Efficient Hybrid Ventilation (HYBVENT) (\*)
- Annex 36: Retrofitting of Educational Buildings (\*)
- Annex 37: Low Exergy Systems for Heating and Cooling of Buildings (LowEx) (\*)
- Annex 38: Solar Sustainable Housing (\*)
- Annex 39: High Performance Insulation Systems (\*)
- Annex 40: Building Commissioning to Improve Energy Performance (\*)
- Annex 41: Whole Building Heat, Air and Moisture Response (MOIST-ENG) (\*)
- Annex 42: The Simulation of Building-Integrated Fuel Cell and Other Cogeneration Systems (FC+COGEN-SIM) (\*)
- Annex 43: Testing and Validation of Building Energy Simulation Tools (\*)
- Annex 44: Integrating Environmentally Responsive Elements in Buildings (\*)
- Annex 45: Energy Efficient Electric Lighting for Buildings (\*)
- Annex 46: Holistic Assessment Tool-kit on Energy Efficient Retrofit Measures for Government Buildings (EnERGo) (\*)
- Annex 47: Cost-Effective Commissioning for Existing and Low Energy Buildings (\*)
- Annex 48: Heat Pumping and Reversible Air Conditioning (\*)
- Annex 49: Low Exergy Systems for High Performance Buildings and Communities (\*)
- Annex 50: Prefabricated Systems for Low Energy Renovation of Residential Buildings (\*)
- Annex 51: Energy Efficient Communities (\*)
- Annex 52: Towards Net Zero Energy Solar Buildings (\*)
- Annex 53: Total Energy Use in Buildings: Analysis & Evaluation Methods (\*)
- Annex 54: Integration of Micro-Generation & Related Energy Technologies in Buildings (\*)
- Annex 55: Reliability of Energy Efficient Building Retrofitting - Probability Assessment of Performance & Cost (RAP-RETRO) (\*)
- Annex 56: Cost Effective Energy & CO2 Emissions Optimization in Building Renovation
- Annex 57: Evaluation of Embodied Energy & CO2 Equivalent Emissions for Building Construction
- Annex 58: Reliable Building Energy Performance Characterisation Based on Full Scale Dynamic Measurements
- Annex 59: High Temperature Cooling & Low Temperature Heating in Buildings
- Annex 60: New Generation Computational Tools for Building & Community Energy Systems
- Annex 61: Business and Technical Concepts for Deep Energy Retrofit of Public Buildings
- Annex 62: Ventilative Cooling
- Annex 63: Implementation of Energy Strategies in Communities
- Annex 64: LowEx Communities - Optimised Performance of Energy Supply Systems with Exergy Principles
- Annex 65: Long Term Performance of Super-Insulating Materials in Building Components and Systems
- Annex 66: Definition and Simulation of Occupant Behavior Simulation
- Annex 67: Energy Flexible Buildings
- Annex 68: Design and Operational Strategies for High IAQ in Low Energy Buildings

Annex 69: Strategy and Practice of Adaptive Thermal Comfort in Low Energy Buildings  
Annex 70: Energy Epidemiology: Analysis of Real Building Energy Use at Scale

Working Group - Energy Efficiency in Educational Buildings (\*)  
Working Group - Indicators of Energy Efficiency in Cold Climate Buildings (\*)  
Working Group - Annex 36 Extension: The Energy Concept Adviser (\*)

## **IEA EBC Annex 58: Reliable Building energy performance characterisation based on full scale dynamic measurements**

### Annex 58 in general

To reduce the energy use of buildings and communities, many industrialised countries have imposed more and more stringent requirements in the last decades. In most cases, evaluation and labelling of the energy performance of buildings are carried out during the design phase. Several studies have shown, however, that the actual performance after construction may deviate significantly from this theoretically designed performance. As a result, there is growing interest in full scale testing of components and whole buildings to characterise their actual thermal performance and energy efficiency. This full scale testing approach is not only of interest to study building (component) performance under actual conditions, but is also a valuable and necessary tool to deduce simplified models for advanced components and systems to integrate them into building energy simulation models. The same is true to identify suitable models to describe the thermal dynamics of whole buildings including their energy systems, for example when optimising energy grids for building and communities.

It is clear that quantifying the actual performance of buildings, verifying calculation models and integrating new advanced energy solutions for nearly zero or positive energy buildings can only be effectively realised by in situ testing and dynamic data analysis. But, practice shows that the outcome of many on site activities can be questioned in terms of accuracy and reliability. Full scale testing requires a high quality approach during all stages of research, starting with the test environment, such as test cells or real buildings, accuracy of sensors and correct installation, data acquisition software, and so on. It is crucial that the experimental setup (for example the test layout or boundary conditions imposed during testing) is correctly designed, and produces reliable data. These outputs can then be used in dynamic data analysis based on advanced statistical methods to provide accurate characteristics for reliable final application. If the required quality is not achieved at any of the stages, the results become inconclusive or possibly even useless. The IEA EBC Annex 58-project arose from the need to develop the necessary knowledge, tools and networks to achieve reliable in situ dynamic testing and data analysis methods that can be used to characterise the actual energy performance of building components and whole buildings. As such, the outcome of the project is not only of interest for the building community, but is also valuable for policy and decision makers, as it provides opportunities to make the step from (stringent) requirements on paper towards actual energy performance assessment and quality checking. Furthermore, with the developed methodology it is possible to characterise the dynamic behaviour of buildings, which is a prerequisite for optimising smart energy and thermal grids. Finally, the project developed a dataset to validate numerical Building Energy Simulation programs.

### Structure of the project

Successful full scale dynamic testing requires quality over the whole process chain of full scale testing and dynamic data analysis: a good test infrastructure, a good experimental set-up, a reliable dynamic data analysis and appropriate use of the results. Therefore, the annex-project was organised around this process chain, and the following subtasks were defined:

**Subtask 1** made an inventory of full scale test facilities available all over the world and described the common methods with their advantages and drawbacks for analysing the obtained dynamic data. This subtask produced an overview of the current state of the art on full scale testing and dynamic data analysis and highlighted the necessary skills.

**Subtask 2** developed a roadmap on how to realise a good test environment and test set-up to measure the actual thermal performance of building components and whole buildings in situ. Since there are many different objectives when measuring the thermal performance of buildings or building components, the best way to treat this variety has

been identified as constructing a decision tree. With a clear idea of the test objective, the decision tree will give the information of a test procedure or a standard where this type of test is explained in detail.

**Subtask 3** focused on quality procedures for full scale dynamic data analysis and on how to characterise building components and whole buildings starting from full scale dynamic data sets. The report of subtask 3 provides a methodology for dynamic data analysis, taking into account the purpose of the in situ testing, the existence of prior physical knowledge, the available data and statistical tools,... The methodologies have been tested and validated within different common exercises, in a way that quality procedures and guidelines could be developed.

**Subtask 4** produced examples of the application of the developed concepts and showed the applicability and importance of full scale dynamic testing for different issues with respect to energy conservation in buildings and community systems, such as the verification of common BES-models, the characterisation of buildings based on in situ testing and smart meter readings and the application of dynamic building characterisation for optimising smart grids.

**Subtask 5** established a network of excellence on ‘in situ testing and dynamic data analysis’ for dissemination, knowledge exchange and guidelines on testing.

### Overview of the working meetings

The preparation and working phase of the project encompassed 8 working meetings:

Meeting	Place, date	Attended by
Kick off meeting	Leuven (BE), September 2011	45 participants
Second preparation meeting	Bilbao (SP), April 2012	46 participants
First working meeting	Leeds (UK), September 2012	44 participants
Second working meeting	Munich (GE), April 2013	53 participants
Third working meeting	Hong-Kong (CH), September 2013	26 participants
Fourth working meeting	Gent (BE), April 2014	49 participants
Fifth working meeting	Berkeley (USA), September 2014	37 participants
Sixth working meeting	Prague (CZ), April 2015	39 participants

During these meetings, working papers on different subjects related to full scale testing and data analysis were presented and discussed. Over the course of the Annex, a Round Robin experiment on characterising a test box was undertaken, and several common exercises on data analysis methods were introduced and solved.

### Outcome of the project

The IEA EBC Annex 58-project worked closely together with the Dynastee-network ([www.dynastee.info](http://www.dynastee.info)). Enhancing this network and promoting actual building performance characterization based on full scale measurements and the appropriate data analysis techniques via this network is one of the deliverables of the Annex-project. This network of excellence on full scale testing and dynamic data analysis organizes on a regular basis events such as international workshops, annual training,... and will be of help for organisations interested in full scale testing campaigns.

In addition to the network of excellence, the outcome of the Annex 58-project has been described in a set of reports, including:

Report of Subtask 1A: Inventory of full scale test facilities for evaluation of building energy performances.

Report of Subtask 1B: Overview of methods to analyse dynamic data

Report of Subtask 2: Logic and use of the decision tree for optimizing full scale dynamic testing.

Report of Subtask 3 part 1: Thermal performance characterization based on full scale testing: physical guidelines and description of the common exercises

Report of Subtask 3 part 2: Thermal performance characterization using time series data – statistical guidelines.

Report of Subtask 4A: Empirical validation of common building energy simulation models based on in situ dynamic data.

Report of Subtask 4B: Towards a characterization of buildings based on in situ testing and smart meter readings and potential for applications in smart grids

IEA EBC Annex 58 project summary report



## Participants

In total 49 institutes from 17 countries participated in Annex 58. The different participants are listed below:

Austria	Gabriel Rojas-Kopeinig, Universität Innsbruck Susanne Metzger, Vienna University of Technology
Belgium	Gilles Flamant, Belgian Building Research Institute Guillaume Lethé, Belgian Building Research Institute <b>Luk Vandaele, Belgian Building Research Institute (subtask 5 co-leader)</b> Paul Steskens, Belgian Building Research Institute Gabrielle Masy, Haute Ecole de la Province de Liège An-Heleen Deconinck, Katholieke Universiteit Leuven <b>Dirk Saelens, KU Leuven (subtask 4 co-leader)</b> <b>Geert Bauwens, KU Leuven (secretary)</b> Glenn Reynders, KU Leuven Ruben Baetens, KU Leuven Roel De Coninck, KU Leuven <b>Staf Roels, KU Leuven (operating agent)</b> Frédéric Delcuve, Knauf Insulation Philippe André, Université de Liège <b>Arnold Janssens, Universiteit Gent (subtask 1 leader)</b> Eline Himpe, Universiteit Gent
China	Gongshen Huang, City University of Hong Kong Tin-Tai Chow, City University of Hong Kong Linda Xiao Fu, The Hong Kong Polytechnic University <b>Shengwei Wang, The Hong Kong Polytechnic University (subtask 4 co-leader)</b> Xue Xue, The Hong Kong Polytechnic University
Czech Republic	Kamil Stanek, Czech Technical University Prague Pavel Kopecký, Czech Technical University Prague
Denmark	Christian Holm Christiansen, Danish Technological Institute Søren Østergaard Jensen, Danish Technological Institute <b>Henrik Madsen, Technical University of Denmark (subtask 3 co-leader)</b> Kyung Hun (Peter) Woo, Technical University of Denmark Peder Bacher, Technical University of Denmark
France	Bouchie Remi, Centre Scientifique et Technique du Bâtiment Pierre Boisson, Centre Scientifique et Technique du Bâtiment Mohamed El Mankibi, Ecole Nationale des Travaux Publics de l'Etat Christian Ghiaus, INSA de Lyon Ibán Naveros, INSA de Lyon Guillaume Pandraud, Isover Saint-Gobain Simon Rouchier, Université de Savoie
Germany	Franz Feldmeier, Fachhochschule Rosenheim Lucia Bauer, Fachhochschule Rosenheim Herbert Sinnesbichler, Fraunhofer-Institut für Bauphysik Ingo Heusler, Fraunhofer-Institut für Bauphysik Matthias Kersken, Fraunhofer-Institut für Bauphysik Soeren Peper, Passive House Institute
Italy	Fabio Moretti, ENEA <b>Hans Bloem, European Commission - DG JRC (subtask 5 co-leader)</b> Lorenzo Pagliano, Politecnico di Milano Giuseppina Alcamo, Università degli Studi di Firenze
The Netherlands	A.W.M. van Schijndel, Technische Universiteit Eindhoven Rick Kramer, Technische Universiteit Eindhoven
Norway	Nathalie Labonnote, Norges teknisk-naturvitenskapelige universitet
Spain	Gerard Mor-Lleida, Centro Internacional de Métodos Numéricos en Ingeniería Xavi Cipriano, Centro Internacional de Métodos Numéricos en Ingeniería <b>Aitor Erkoreka, Escuela Técnica Superior de Ingeniería Bilbao (subtask 2 co-leader)</b> Koldo Martin Escudero, Escuela Técnica Superior de Ingeniería Bilbao

Roberto Garay Martínez, TecNALIA Research & Innovation  
Luis Castillo López, CIEMAT  
**Maria José Jiménez Taboada, CIEMAT (subtask 3 co-leader)**  
Ricardo Enríquez Miranda, CIEMAT  
United Kingdom Richard Fritton, Salford University  
**Chris Gorse, Leeds Beckett University (subtask 2 co-leader)**  
Martin Fletcher, Leeds Beckett University  
Samuel Stamp, University College London  
Filippo Monari, University of Strathclyde  
United States **Paul A. Strachan, University of Strathclyde (subtask 4 co-leader)**  
Stephen Selkowitz, Lawrence Berkeley National Laboratory

# IEA, EBC Annex 58, Report of Subtask 1a

## Inventory of full scale test facilities for evaluation of building energy performances

Arnold Janssens

April 2016

### TABLE OF CONTENTS

Introduction.....	3
<b>Part 1: Facilities for outdoor testing of building components</b>	
Building science research and test unit BSRTU, Carinthia University of Applied Sciences, Austria.....	9
Test site UIBK Innsbruck, Austria.....	17
The VLIET test building, KULeuven, Belgium .....	25
NRC-IRC Field exposure of Walls facility, NRC, Canada.....	35
The Cube, Aalborg University, Denmark.....	43
Outdoor testing site, IBP Holzkirchen, Germany.....	51
Calorimetric test facility for façades and roofs, IBP Holzkirchen, Germany.....	57
LWF Façade facility, Rosenheim University of Applied Sciences, Germany.....	63
Test cell in Florence, UNIFI, Italy.....	73
ZEB test cell, SINTEF-NTNU, Norway.....	81
Eguzki and Ilargi PASLINK test cells, LCCE Vitoria-Gasteiz, Spain.....	85
LECE-UiE3, CIEMAT, Spain .....	97
Lleida Outdoor Test cell for double-skin systems, CIMNE, Spain.....	111
<b>Part 2: Facilities for energy use analysis at whole building level</b>	
Jacques Geelen Laboratory, ULg Arlon Campus, Belgium.....	117
Lecture Rooms at KAHO, KULeuven, Belgium.....	123
Energy Flex house, DTI, Denmark.....	129
INCAS Platform INES, National Institute for Solar Energy, France .....	139
VERU test facility, IBP Holzkirchen, Germany.....	147

Twin houses, IBP Holzkirchen, Germany.....	155
Zero-energy certified passive house test building, Politecnico di Milano, Italy.....	161
DEFI-experimental platform, ENTPE, Morocco.....	167
ARFRISOL Buildings UIE3, CIEMAT, Spain .....	171
KUBIK by TECNALIA, Spain.....	185
Salford Energy House, University of Salford, United Kingdom.....	191
FLEXLAB: Facility for Low Energy Experiments in Buildings, LBNL, USA.....	197

# 1. Introduction

## **The role of full scale testing for evaluation of energy performances of buildings (Roels 2011)**

The rise of living standards, the scarcity of natural resources and the awareness of climate change resulted in an international pressure to significantly reduce the energy consumption of buildings and communities. In several countries more stringent requirements are imposed by energy performance legislation and also an increased awareness for environmental issues in building codes can be noticed. Mostly, requirements and labelling of the energy performances of buildings is done in the design phase by calculating the theoretical energy consumption. Several studies showed however that the real performance after realisation of the building may deviate significantly from this theoretically designed performance. Building and component energy performance characterisation based on full scale dynamic measurements could help to bridge the gap between theoretically predicted and real life performance of buildings.

Full scale testing however, requires quality on all topics of the process chain, starting with a good test infrastructure. Only when this is present a good experimental set-up can be designed, which produces reliable data that can be used for dynamic data analysis to come to a characterisation of performances and final assessment of the results. As soon as the required quality fails on one of these topics, the results of full scale testing become inconclusive. In the light of the importance of real building performance characterisation, the IEA EBC Annex 58 was set up as an international research collaboration on the topic 'Reliable building energy performance characterization based on full scale dynamic measurements'. The ultimate goal of the Annex is to develop the necessary knowledge, tools and networks to achieve reliable in situ dynamic testing and data analysis methods that can be used to characterize the actual energy performance of building components and whole buildings.

### **Full scale test facilities: overview**

The aim of the first subtask of IEA EBC Annex 58 was to give an overview and evaluation of previous and ongoing in situ test activities based on a literature review and existing reports. An inventory was made of full scale test facilities for the evaluation of energy performances of building components and systems, available at different institutes all over the world. Furthermore common methods were described to analyse dynamic data, with their advantages and drawbacks.

This report relates to the first part of the subtask, and gives a description of 25 existing test facilities or test sites according to their main functionalities: objectives, lay-out of the infrastructure, typical equipment and operation, examples of measuring campaigns and analysis methods. The descriptions were provided by the participants of IEA-Annex 58, and complemented by descriptions which were previously published in the book on 'Full scale test facilities' (Janssens et al., 2011). The inventory provides examples and background to building researchers responsible for the design and construction of new test facilities or for the management of existing ones.

Full scale test facilities may be defined as facilities, specifically constructed for experimental use, where the energy related performances of building components, systems or whole buildings are studied in full scale in response to realistic boundary conditions (Hitchin 1993). To achieve this, the facility requires a high degree of control of the indoor environment, well-specified constructions, and high levels of instrumentation (Strachan and Baker 2008). As this type of facilities can fill the gap between precise laboratory experiments and energy monitoring in real buildings in use, also the test approaches applied in these facilities range between both

extremes. Table 1 gives an overview of the different facilities included in this Subtask 1 report, ordered per country, with information about the first year of operation of the facility, and the type of facilities available on the test site. Facilities with a long tradition as well as recently developed platforms are described.

Country	Facility	Year	Institute	Type of facility			
				Façade field test	Outdoor test cell	Test building	In-use testing
Austria	BSRTU facility	2010	BSRTU	X			
	Test site UIBK	2010	UIBK	X	X		
Belgium	VLIET test building	1996	KULeuven	X			
	J. Geelen laboratory	2002	ULg			X	
	Lecture rooms KAHO	new	KULeuven				X
Canada	Field exposure of walls	2006	NRC-IRC	X			
Denmark	The Cube	2005	U-Aalborg	X			
	Energy Flex House	2009	DTI	X		X	X
France	INCAS Platform	2008	INES	X	X	X	
Germany	Test site Holzkirchen	1950	IBP	X			
	VERU facility	2004	IBP	X		X	
	Twin houses	2010	IBP			X	
	Calorimetric test facility	2012	IBP	X	X		
	LWF Façade facility	2011	FH-Rosenheim	X	X		
Italy	Florence test cell	2014	UniFI	X	X		
	Passive house test building	new	Polimi				X
Morocco	DEFI experimental platform	new	ENTPE				X
Norway	ZEB test cell	2015	SINTEF	X	X		
Spain	Eguzki and Ilargi test cells	1988	LCCE	X	X		
	LECE-UiE3	1989	CIEMAT	X	X	X	
	ARFRISOL Buildings	2005	CIEMAT				X
	KUBIK	2010	Tecnalia	X		X	
	Lleida Outdoor Test cell	2011	CIMNE	X			
UK	Salford Energy House	2011	U-Salford			X (in lab)	
USA	FLEXLAB	2014	LBNL	X		X	

Table 1: General overview of test facilities

## Facilities for outdoor testing of building components

A large group of facilities is designed to study and quantify the performance of full scale building components in realistic climatic conditions. In these facilities this is achieved by means of a well-controlled indoor environment and by exposing components to the real climate in the field. Building components may include opaque walls, advanced glazed façades, sloped and flat roofs, etc..., while the performances under investigation range from thermal and solar to moisture performance. The test results are used to evaluate the validity of model predictions, or to characterise component performances related to their behaviour in real climatic conditions. Table 2 gives an overview of the functionalities and features of this group of test facilities. The size of the building components that can be tested varies, but a one storey high component (>2.7 m) with a width in the order of 2 m seems to be a minimum for full scale testing in the listed facilities. A number of facilities is installed on rotating devices for testing building components in different orientations or inclinations, sometimes in an automated way by sun tracking. This way the flexibility of the facility to accommodate multiple tests is increased.

One approach to analyse the dynamic (hygro)thermal behaviour and response of a building component is by monitoring its physical conditions using high levels of instrumentation, such as heat flux transducers, temperature sensors, etc... In Table 1 this test approach is referred to as 'façade field testing'. Often comparative testing is applied, by simultaneously exposing

test elements with different designs to the same indoor and outdoor conditions, allowing for a side-by-side comparison of their behaviour and performance.

Country	Facility	Aim		Component				Features			
		Model validation	Characterisation	Scale: wxh (m)	Opaque wall	Glazed façade	Roof element	Side-by-side test	Calorimetric test	Turnable	Tiltable
Austria	BSRTU facility	X	X	2.4x2.7	X		X	X			
	Test site UIBK	X	X	2.7x2.7	X	X			X		
Belgium	VLIET test building	X	X	1.8x2.7	X	X	X	X			
Canada	Field exposure of walls	X	X	7.5x3.2	X			X			
Denmark	The Cube	X		3.5x5.5		X					
France	INCAS Platform	X	X	3.3x3.6	X	X		X	X	X	
Germany	Calorimetric test facility	X	X	3.5x3.8		X			X	X	X
	LWF Façade facility	X	X	2.2x2.9		X		X	X	X	X
Italy	Florence test cell	X	X	2.8x2.8	X	X			X	X	
Norway	ZEB test cell	X	X	3.6x3.0	X	X	X	X	X		
Spain	Eguzki and Ilargi test cells	X	X	2.7x2.7	X	X	X		X		
	LECE-UiE3	X	X	2.7x2.7	X	X	X		X	X	
	Lleida Outdoor Test cell	X		3.5x5.5		X					
USA	FLEXLAB	X	X	7.6x8.0	X	X	X	X		X	

Table 2: Features of facilities for outdoor testing of building components

Another approach to analyse the thermal behaviour of a building component is by an indirect measurement of the net heat flow through the component. This approach is crucial when non homogeneous or transparent components are tested, since direct, point-wise measurements are not sufficient in these cases to define thermal and solar performances. The indirect measurement of the net heat flow through the component requires the use of a highly specified and instrumented facility specifically designed to measure this latter quantity in an accurate way. Based on methods of dynamic data analysis, specific performances may be quantified. In Table 1 this type of facility is referred to as 'outdoor test cell', sometimes also called 'calorimetric test cell'.

## Facilities for energy use analysis at whole building level

Another group of facilities is designed to study energy use and indoor environmental quality under realistic dynamic conditions at building level, in relation to the building services and building envelope solutions installed in the test buildings. In most existing facilities this is achieved by means of a well-controlled indoor environment and by exposing the building to the real climate in the field. However there is also an example of a test building located within an environmentally controlled chamber, examples of facilities where user behaviour is emulated in order to obtain realistic indoor conditions. As Hitchin (1993) observed, the geometry and construction of this type of facilities is usually simplified and more precisely defined compared to 'real' buildings. As a result, it is easier to obtain high levels of instrumentation and control which allows for a more accurate and straightforward analysis of measuring data. To further reduce uncertainties, facilities for energy use analysis are typically unoccupied (although user schedules may be emulated). In Table 1, this is referred to as a 'test building' type of facility.

A smaller number of more recent test buildings are specifically designed for in-use testing with occupants present, and are categorized as a separate type of facility in Table 1. In-use testing

of dedicated test buildings helps to investigate the relation between user behaviour, building and system design, indoor environmental quality and building energy use.

Table 3 gives an overview of existing test buildings. Objectives of these facilities are manifold:

- Investigation of the effectiveness of energy saving measures, at building envelope as well as building services level;
- Energy system analysis
- BES model development (Building Energy Simulation)
- Evaluation of test methods for commissioning
- User-system interaction studies

In most facilities comparative testing is possible, by testing different designs in two or more identical buildings or in two or more identical modular rooms within the same test building.



Figure 1: Examples of different types of full scale test facilities (left to right): facility for façade field testing, outdoor test cell, test buildings for energy use analysis and facility for in-use testing.

Country	Facility	Floor area (m <sup>2</sup> )	Features			
			Identical buildings	Side-by-Side test	Unoccupied test building	Occupied test building
Belgium	J. Geelen laboratory	12			X	
	Lecture rooms KAHO	NA				X
Denmark	Energy Flex House	216		X	X	X
France	INCAS Platform	95	X	X	X	
Germany	VERU facility	432		X	X	
	Twin houses	82	X	X	X	
Italy	Passive house test building	NA				X
Morocco	DEFI experimental platform	NA				X
Spain	LECE-UiE3	32			X	
	ARFRISOL Buildings	>1000				X
	KUBIK	500		X	X	
UK	Salford Energy House	NA			X	
USA	FLEXLAB	112		X	X	

Table 3: Features of test buildings for energy use analysis

## Common points of attention

Several authors in this book stress the importance of complementing full scale dynamic testing with other test methods, such as material property measurements and steady-state experiments (eg guarded hot box apparatus). These complementary tests are needed to improve the analysis of the dynamic test data and the reliable investigation of building performance. The results of full scale dynamic testing may also help to develop new standard test methods, for example representative accelerated ageing tests, when moisture performance and durability is the scope of the investigation.



Further the application and development of modelling and simulation methods is essential for the quality of full scale dynamic testing. Modelling plays an important role in experimental design, in dynamic data analysis, performance quantification, and in system emulation. Well documented experimental data sets from full scale test facilities allow for the validation of new numerical models. Validated simulation tools in return may be applied to extrapolate the experimental findings to long-term performance figures and to assess performances in other than the test conditions.

A common challenge in all facilities is the reliable quantification of performances based on the experimental results, which requires the development of quality procedures for testing. Following elements are important to consider:

- The accuracy, calibration, position, shielding and number of sensors
- The possibilities to control the indoor environment according to predefined schedules
- Procedures for calibration of the test infrastructure
- The management of large numbers of data
- The dynamic analysis methods for performance and error estimation

## **Structure of the report**

This report is subdivided in two parts, related to the scale at which building energy performances are analysed. The first part contains descriptions of test facilities for outdoor testing of full scale building components, as listed in Table 2. The second part contains the descriptions of test buildings for energy use analysis at building level, as listed in Table 3. In each part the descriptions are ordered in alphabetical order per country. Test sites which have both types of facilities are included in the part for which the test site description offers the most relevant information.

## **References**

Hitchen, R. 1993. Editorial, Special Issue Thermal Experiments in Simplified Buildings, *Building and Environment* 28(2), 105-106.

Full scale test facilities for evaluation of energy and hygrothermal performances (A. Janssens, S. Roels, L. Vandaele, ed.). 2011. Brussels International Workshop, March 30-31 2011, ISBN 978-94-9069-584-2 (158 pp.).

Roels S. 2011. Reliable building energy performance characterization based on full scale dynamic measurements, Proposal for a new IEA ECBCS-Annex.

Strachan P., P. Baker. 2008. Editorial, Outdoor testing, analysis and modelling of building components, *Building and Environment* 43, 127-128.



# BUILDING SCIENCE - RESEARCH & TEST UNIT

## CARINTHIA UNIVERSITY OF APPLIED SCIENCES



Institute/organisation:

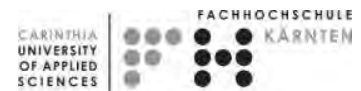

**BSRTU**  
BUILDING SCIENCE  
RESEARCH & TEST UNIT  
BUILDING-SCIENCE.at

## GENERAL DESCRIPTION

### Major aim of the test facility

The BSRTU test facility is a full scale facility based on a modular concept constructed in 2010. The test facility allows for R&D studies regarding the hygrothermal performance of full scale building assemblies under real climate conditions. The test facility is designed as a flexible, rectangular box with longitudinal façades facing to the North and South, hence building components can be tested under varying climate impacts at the same time. The western façade is used for studies regarding wind driven rain impact.

At this time the modular test facility is arranged with low-sloped roof constructions only, which are investigated during a commissioning work of a business partner, but it would be possible to add static timber elements for studies regarding sloped roofs too.

Building Science Section  
Department of Civil Engineering &  
Architecture  
Carinthia University  
of Applied Sciences  
Austria

Contact person:

Prof. Dr. Christoph Buxbaum  
Villacher Strasse 1  
A- 9800 Spittal an der Drau  
AUSTRIA  
tel: 43(0)676.89015.1132  
c.buxbaum@fh-kaernten.at  
www.building-science.at

Exact location:

Villach, Austria  
46° 36' 53" N, 13° 50' 46" E

### Overall lay-out

The test facility's load-bearing static construction is made of a wooden frame structure. Various test elements like wall or roof sections can be installed into the open areas in-between the elements of this frame structure. The overall building size (~ 10,30 / 18,20m) is based on the designed dimension of the test walls and roofs. Separations in the roof area allow for testing 14 different roof assemblies of maximum dimensions of up to 2.4 / 5.0m. In addition wall or façade elements with a maximum height of 2.70m can be installed. The wall's width is variable because the single separators can easily be displaced. Static columns are placed at a distance of 1m from the wall assemblies, hence even connection and joint details, but also corners can be analyzed under real climatic conditions in a 1:1 scale.



Schematic draft of test facility



Static structure of test facility



Facility during erection process



Mounting of roof assemblies



Mounting of wall assemblies

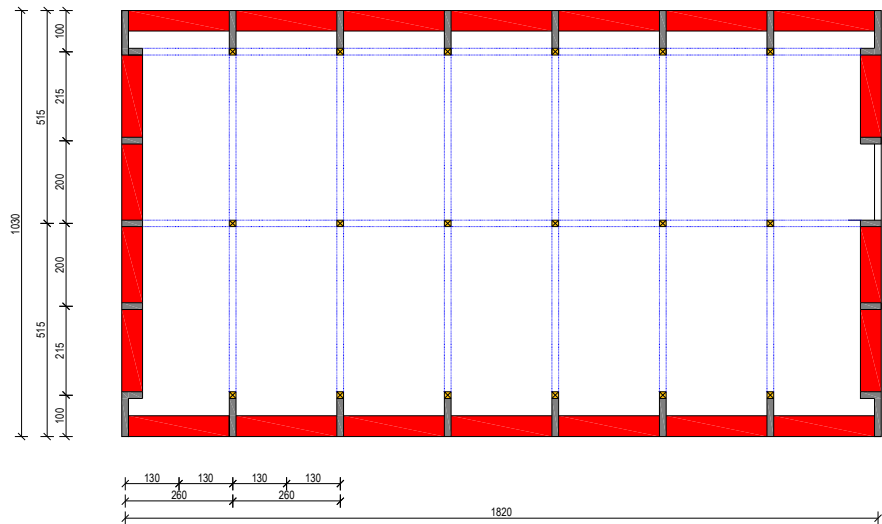

Schematic floor plan of the CUAS test facility (to scale)

### Inside boundary conditions

The test facility is equipped with a double air conditioning system. The HVAC system is used for heating and cooling and can easily be adjusted. The main part of the facility, used for building enclosure tests, is executed with one single climate, varying between ~ 20-24°C and 30-50% RH depending on the season. The humidity level inside the room is adjusted by using multiple humidifying appliances.

The second room section on the western façade is equipped with a separate HVAC system. Here also translucent building materials like membrane structures, etc. can be investigated without disturbing the climate profile in main testing room. In addition, due to the modular concept of the test facility, single assemblies can also be separated from the main room and stressed with high moisture loads.

## PART 1: Facilities for outdoor testing of building components

The indoor climate is monitored in a 10 minute interval with more than 20 heat / moisture sensors, placed in different sections of the test facility.

### Outside boundary conditions

The whole test facility is exposed to the prevalent weather conditions at the location. Villach is located in Austria's most southern province Carinthia in the border triangle to Italy and Slovenia.

Location Villach:

46° 36' 53" N, 13° 50' 46" E  
501 m above sea level

Table right:

Overview: outside air temperature & relative humidity; location Villach

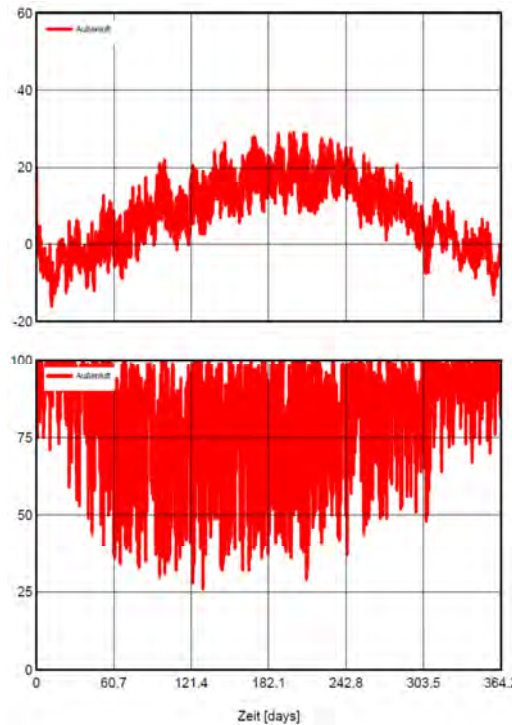

The outside weather conditions are measured with two different weather stations (temperature, relative humidity, global solar radiation and direct solar radiation on façades and shaded and unshaded roof sections, wind velocity and direction with ultrasonic anemometers. Precipitation is measured with rainfall sensors and precipitation detectors. In addition also UVA- & UVB radiation probe heads and star pyranometers are used.

### Special limitations / possibilities

The CUAS test facility is especially used for research work regarding the hygrothermal performance of different building enclosures but also the interaction of building components with the indoor comfort conditions can be investigated.

The whole measurement data at the test facility (more than ~ 1200 different sensors) is monitored automatically and accessible to project partners over the web.



Study on different low-sloped roof assemblies (cool roofing, etc.)



Investigation regarding roof shadings



Research regarding Façade ventilation



Research regarding building integrated PV and solar thermal panels



Research regarding fungi growth in building envelopes made in timber construction



Inside view of facility: Datalogging of building elements



Datalogging device

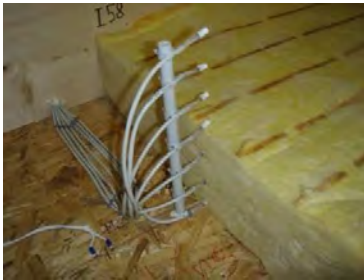

Combined heat/moisture sensors in roof assembly



Sensor positioning in a wall assembly



Prefabrication and mounting of sensors in different building assemblies

The Building Science division @ the CUAS focuses on the following core research fields:

- Energy efficiency and durability of building enclosure systems;
- Interaction and influence of the building enclosure on the quality of the interior rooms;
- Analysis of building products and materials in due consideration of environmental influences

CUAS' objectives are to actively transfer the research knowledge to teaching by directly involving students in the development, research, and innovation activities as well as to incorporate the development, research, and innovation knowledge in teaching at the university and in advanced training for companies in the building industry, etc.

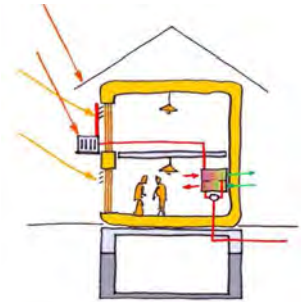

## DATA ANALYSIS

### Typical equipment within test wall

In the BSRTU test facility the typical measurement equipment for a single assembly consists of thermocouples, relative humidity sensors and dewpoint/condensate detectors, which are installed at interfaces of different building materials, but also e.g. within insulation layers. Attached at their surfaces, also heat flux sensors are installed.

The number of installed sensors depends on the scope of the research work.

### Accuracy and logging resolution

Instrument	Manufacturer	Model	Measurement Range	Accuracy
Dataloggers	Ahlborn	Almemo® 5690, 2890-9		
Combined relative humidity and temperature sensor	Ahlborn	Almemo® FHAD460	0...100%rh	±1,8 %rh within 20...80 % rh
Capacitive humidity sensor	Ahlborn	Almemo® FHA646	0...100 %rh	±2 %rh below 90%rh
Combined relative humidity and	Proprietary		0...100 %rh	±2 %rh within 10 ... 90 %rh

## PART 1: Facilities for outdoor testing of building components

temperature sensor

Thermocouple		NiCr-Ni, Type K	-200 °C ... +205 °C	n.a.
Moisture sensor	Ahlborn	Almemo® FHA636MF	7 ... 30 % moisture in wood	n.a.
Moisture sensor	Proprietary		15 ... 38 % moisture in wood	n.a.
Dew Detector	Ahlborn	Almemo® FHA9461	Dew/no dew	n.a.
Heat Flow Plates	Ahlborn	Almemo® FQA019C	n.a.	5% @ 25 °C

Further sensor equipment: Vaisala Weather Transmitter WXT520, Almemo UVA, UVB and global radiation probe head, Almemo Star Pyranometer, E+E air velocity transmitter EE75.

Data logging is done by means of the above mentioned Almemo® devices as well as in-house developed data loggers based on hardware by National Instruments and special software developed in LabVIEW™. The common logging interval for all these devices is 10 minutes.

### Analysis of the data

The logged data of all the different devices is written to a common database on a central MySQL server. Data analysis and visualization is done by SQL queries carried out in LabVIEW™. The graphical visualization is accessible for the project partners by means of a restricted area of a web portal.

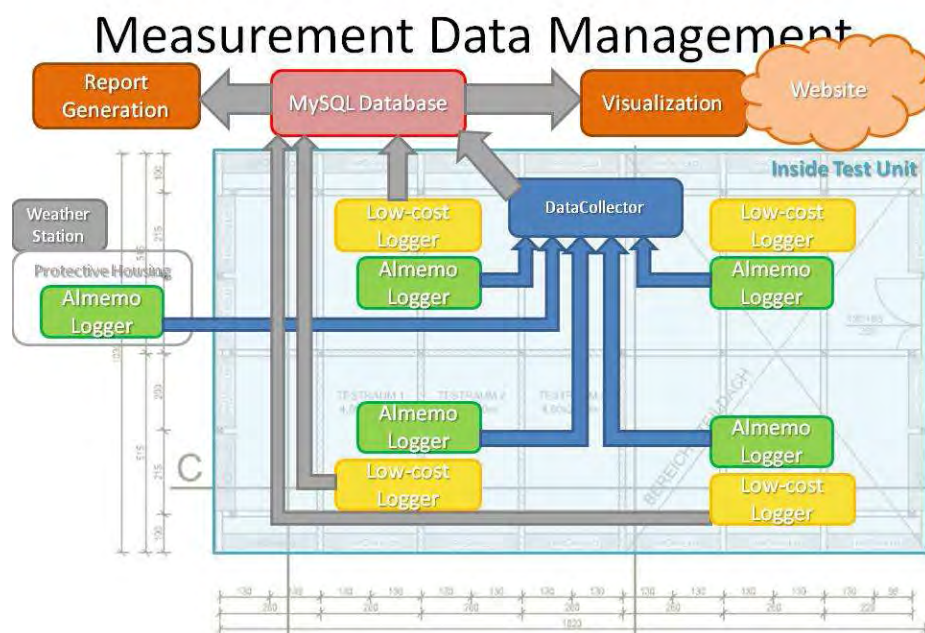

## EXAMPLES OF PREVIOUS STUDIES

The BSRTU test facility is the newest technical infrastructure at the Carinthia University of Applied Sciences and was built in 2010.

Previous hygrothermal studies were done at different research buildings in cooperation with business partners.



*Further CUAS test building, operated with different partners from industry*

## MAINTENANCE / COLLABORATION

### Personnel involved

The BSRTU test facility is maintained by the technical staff of the Building Science Section of the Carinthia University of Applied Sciences. They are also responsible for all new adaptations, data analysis, etc.

Changes or adaptations of building components are done in cooperation with business partners.

### International collaboration

The research team at CUAS is working together with colleagues from:

- Fraunhofer Institute for Building Physics / Holzkirchen, Germany
- Technical University Dresden / Germany - Institute for Building Climatology
- Bergen University College - Høgskolen i Bergen / Norway
- Institute for Building Science & Energy Efficiency / USA



## RELEVANT LITERATURE

### Literature on previous measuring campaigns:

**Buxbaum, C., Gallent, W., Pankratz, O.,** “Hygric performance of shaded and unshaded highly insulated, lightweight low-sloped roofs”, 11<sup>th</sup> International Conference on Thermal Performance of the Exterior Envelopes of Whole Buildings XI, 05 - 09.12.2010, Clearwater Beach / Tampa, USA;

**Buxbaum, C., Gallent, W., Pankratz, O.,** “Thermal Rehabilitation of Existing Building Enclosures by Using VIP (Vacuum Insulation Panel) Sandwich and Timber Based Panels”, 2<sup>nd</sup> BEST - Building Enclosure Science & Technology Conference, 12 - 14.04.2010, Portland / Oregon, USA

**Buxbaum, C.,** „Trocknungspotential von teilweise beschatteten, unbelüfteten Flachdachkonstruktionen“, Internationaler Fachkongress für Holzschutz und Bauphysik, 25 - 26.02.2010, Munich, Germany

**Buxbaum, C., Pankratz, O.,** “Hygrothermal Performance of habitable Basements made in Timber constructions”, 4<sup>th</sup> International Building Physics Conference, 15 - 18.06.2009, Istanbul, Turkey

**Buxbaum, C., Pankratz, O.,** “Moisture performance of well-insulated timber slabs above ventilated crawlspaces in the climate of Central Europe”, 12<sup>th</sup> Canadian Conference on Building Science & Technology, 06 - 08.05.2009, Montreal, Canada

**Buxbaum, C., Pankratz, O.,** “Moisture performance of green flat roofs made in timber construction”, Building Envelope Sustainability Symposium, 30.04 - 01.05.2009, Washington DC., USA

**Buxbaum, C., Pankratz, O.,** “Drying performance of masonry walls with inside insulation exposed to different exterior climate conditions”, Building Physics Symposium in honour of Prof. Hens, 29 - 31.10.2008, Leuven, Belgium

**Buxbaum, C., et. al.,** “Habitable basement concepts made in timber construction -Assessment on the durability of walls and floor slabs made of solid cross-laminated timber boards”, WCTE 2008 - 10<sup>th</sup> World Conference on Timber Engineering, 02 - 05.06.2008, Miyazaki, Japan

**Buxbaum, C., Pankratz, O.,** “Durability of high-insulated timber-frame flat roofs”, 11<sup>th</sup> DBMC - 11<sup>th</sup> International Conference on Durability of Building Materials and Components, 11 - 14.05.2008, Istanbul, Turkey

**Buxbaum, C., et. al.** “Study on the Moisture Performance of high-insulated Building Envelopes”, 12<sup>th</sup> International Passive House Conference, 12 - 13. April 2008, Nuremberg, Germany



## TEST SITE UIBK INNSBRUCK



## GENERAL DESCRIPTION

### Main objective of the test facility

The objective of the UIBK test facility at the outdoor test site is to test the thermal and visual (daylight and artificial light) performance of passive and active building components, lighting products and control devices. It is used within several research projects with the aim of analysing and developing prototypes for energy efficient buildings. Besides the two PAS/PASSYS - test cells, there is a test facility for measurement of sound insulation of building elements (air and solid borne sound).

In addition to the research on the thermo-physical behaviour of building components, research on thermal and visual comfort as well as physiological impacts is performed in close collaboration with medical departments.

### Institute/organisation:



University of Innsbruck  
Unit: Energy Efficient Buildings

### Contact person:

Assoz. Prof. Dr.-Ing Rainer Pfluger  
Technikerstr. 13  
A-6020 Innsbruck  
tel: +43/512-507-6564  
e-mail : rainer.pfluger@uibk.ac.at

### Exact location:

Innsbruck, Austria  
47° 15' N, 11° 20' E



Placing the test cell at the UIBK test site



Test cell and Cold-Box in parking position



View of both test cells and replacement of one test facade



View of sound insulation test facility

## Overall lay-out

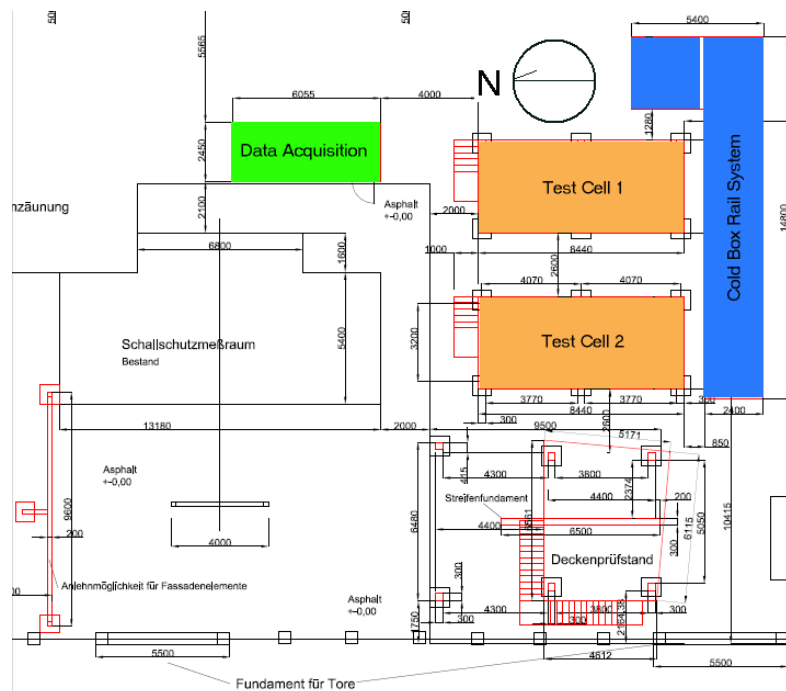

The test site consists of one PAS test cell and one PASSYS test cell, both for test elements with the size of 2,75 x 2,75 m.

In front of both cells, a rail system was constructed for positioning of a so-called “Cold-Box”, which is used to create a constant low temperature in front of the test component. This way, tests under steady state ambient conditions can be performed. North of the test cells, a double chamber sound tests facility is located. At the east side of the test cells, the foundation for a future test device for ceilings is located.

## Inside boundary conditions

The inside temperature can be controlled within a range of 5 to 45 °C by means of a heating (electric) and cooling (hydronic) system via the recirculation air handling unit.

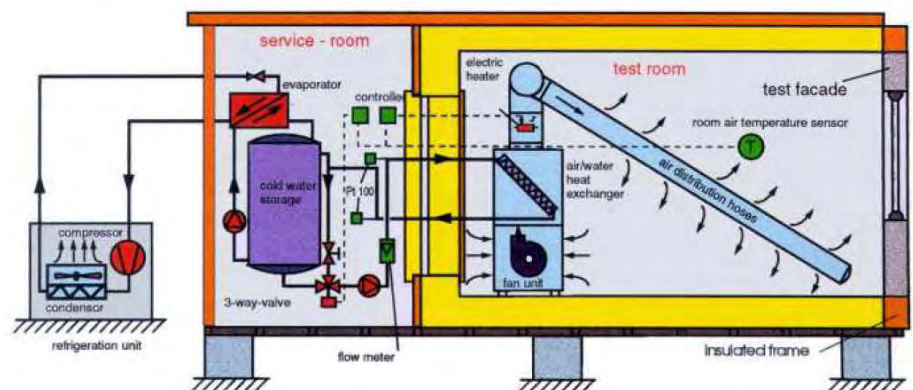

## Outside boundary conditions

The outside boundary conditions are either ambient conditions or they can be kept constant by the Cold-Box (as described above) within a temperature range of  $-15^{\circ}\text{C}$  to  $45^{\circ}\text{C}$ .

The weather station measures dry- and wet-bulb temperature, wind speed, relative humidity (capacitive sensor) and solar radiation (global horizontal, global vertical and diffuse vertical). A pyrgeometer measures the atmospheric long-wave radiation.

## Special limitations / possibilities

The standard heating and cooling system as developed during the EU-projects PASSYS and PASLINK is supplemented by a dehumidification and ambient air ventilation system, which makes it possible to perform tests under different hygro-thermal conditions. This special feature is used for component performance tests as well as for medical tests under controlled adverse conditions.



Rail system for positioning of the movable Cold-Box

# DATA ANALYSIS

## Typical equipment within test wall

The test component is typically equipped with additional temperature sensors (Ni-CrNi thermoelements, Pt100), humidity sensors and heat flux sensors. In actual projects more than 50 sensors are used in one test component.

## Accuracy and logging resolution

Calibrated thermocouples (Ni-CrNi) and Pt100 temperature sensors for air and surface temperatures are in place. Calibration baths and a high precision reference sensor (10 mK) are used. Calibrated heat flux sensors (TUC) and air velocity (Omnisensor) are available. The logging resolution is 10 minute interval for standard measurements (higher resolution on demand for special measurements).

## Analysis of the data

The dynamic data is analysed with MATLAB scripts based on the Optimization Toolbox as well as with the Software LORD for determination of U and g-value of the components. Moreover stationary tests with Cold-Box in front of the component are applied for accurate and fast determination of the U-value under steady state conditions.

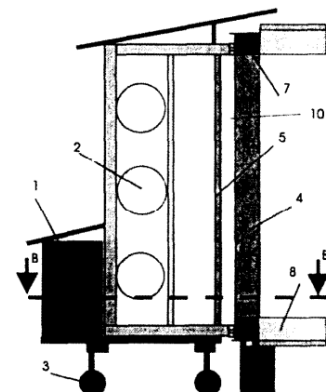
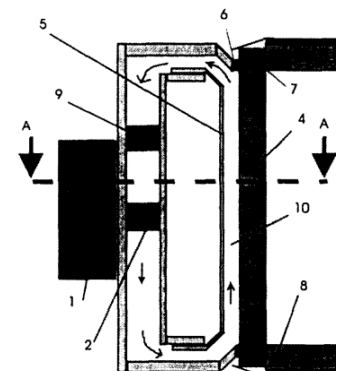

Schematic drawing of Cold-Box in horizontal and vertical section

## EXAMPLES OF PREVIOUS STUDIES



Mounting of test component  
(Project INTENSYS)

The test site in Innsbruck is used for research and development in the field of façade components, innovative daylight and artificial light systems as well as on wall-integrated building services, active solar systems and research on indoor air distribution. The following description will give some examples of previous studies within this wide range of applications.

### Wall integrated HVAC-systems

#### Example 1: Project INTENSYS [1]

First tests on window-components with integrated shading and ventilation system were performed within a research project called INTENSYS (FFG project 818867). The ventilation losses of the heat recovery system in operation were identified as an additional conductance in parallel to the wall/window- component. The test was performed twice (with and without the fans in operation) in order to clearly separate the effect of ventilation losses from the transmission heat losses of the test component (see isothermal and heat flux lines derived from 2D-finite element calculations).



Outside view of wall with  
integrated micro heat pump  
(Project iNSPiRe)

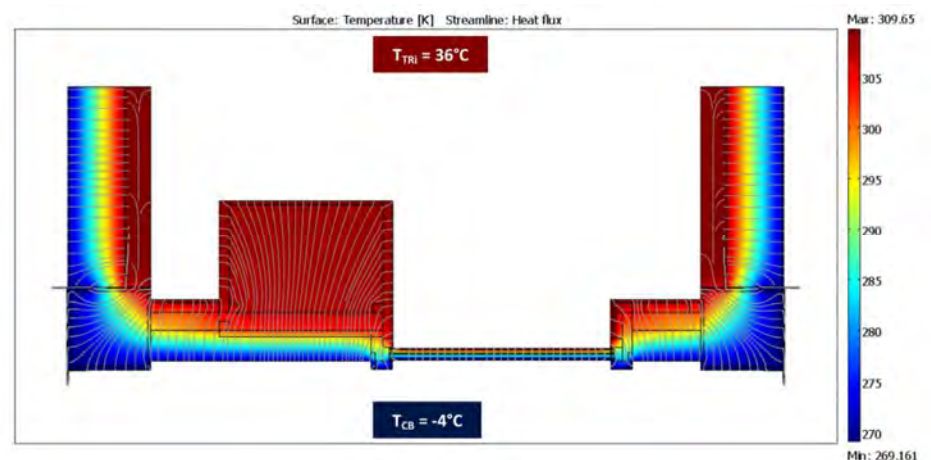

2D-finite element thermal bridge calculation of the test component with ventilation system and window component (horizontal cross section of component, thermal insulated frame and test cell walls)

#### Example 2: Project iNSPiRe (EU, FP7) [3,4,5,6]

A micro-heat pump in combination with a mechanical ventilation with heat recovery (MVHR) unit is developed and integrated in the façade in the framework of the EU-FP7 project iNSPiRe. The heat pump uses the exhaust air of the MVHR unit as source and provides heat to the supply air of the ventilation system. Thus, one compact unit can be used for combined ventilation and heating (and/or cooling). Fresh outdoor air flows into the MVHR unit, where it is heated with a heat recovery efficiency of up to 90 %. It is then further heated by the micro-heat pump up to maximum 52 °C in order to supply space heating (reverse operation for cooling would be possible in

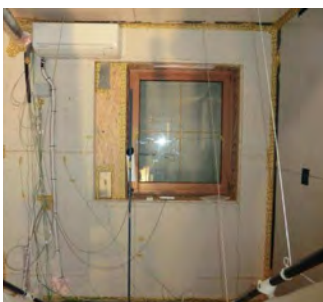

Inside view of wall with  
integrated micro heat pump  
(Project iNSPiRe)

future versions). A simulation study has been performed to investigate the energy performance of the micro-heat pump. A detailed physical model of the  $\mu$ HP is developed within the Matlab simulation environment and validated against measurements of two functional models in the PAS test cells. The system including control will be optimized. Besides the measurements and tests in the test cell, the system will be monitored in a demo building in Ludwigsburg, Germany. The performance of the system is investigated for different renovation standards (EnerPHit with  $25 \text{ kWh}/(\text{m}^2 \cdot \text{a})$  and Passive House with  $15 \text{ kWh}/(\text{m}^2 \cdot \text{a})$ ) at different climatic conditions (7 locations).

## Day- and artificial light

### Example 3: K-Licht (P01)

The second test cell is especially equipped for daylight and artificial light experiments. This type of measurements was performed for the first time within a national research project (K-Licht, P01) within which a specially integrated system for daylight and artificial light and its control was tested.

A new complex fenestration system developed by company Bartenbach is installed which combines the different requirements (control of solar heat gain, glare protection, link to the outside, etc.) of a façade. In the course of the project a new control strategy is developed. This control strategy defines the best blind position and artificial light settings in terms of energy and comfort aspects in each time step. With the help of the PASSYS cell this new development can be tested in real outdoor conditions. For that a new LED electric light system (Zumtobel) is installed, which allows different colour temperature and direct & diffuse settings. With two illuminance sensors on the working surface (one next to the fenestration and one far from the fenestration) the illuminance level could be measured. Furthermore Bartenbach installed a luminance camera detecting glare situations.

Additionally an internal and external spectrometer measures the spectrum from the sky and the transmitted spectrum into the test facility. Furthermore an external daylight sensor "TLM" saves the horizontal and vertical illuminance of each facade orientation. These values can be used as input for the facade control strategies.

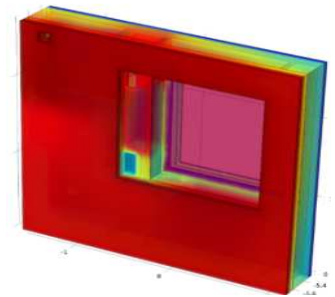

Visualisation of 3D heat flow calculation of wall with integrated micro heat pump



MVHR-unit with micro-heat pump (Project iNSPiRe)

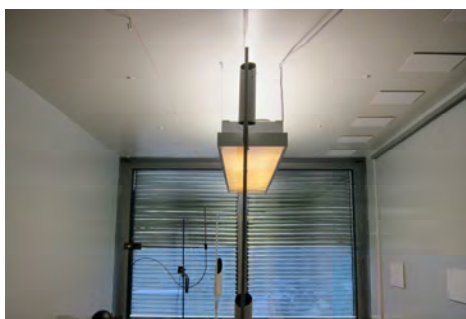

LED Electric Light System

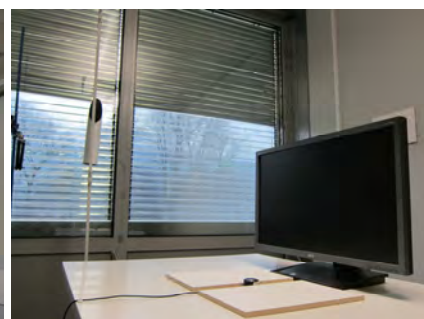

Interior view - Illuminance Sensor



Outside view test component with complex façade system (Project K-Licht)



External spectrometer



Internal spectrometer



Luminance Picture (Source: Bartenbach)

A fisheye webcam installed on the roof of the PASSSYS test cell takes a picture of the sky every minute. This allows an evaluation of the sky conditions compared to the measurements results of the PASSSYS cell.

This measurement equipment allows a holistic light analysis of the façade, artificial light and control strategies.

### Active solar systems (wall integration)

**Example 4: GAP water:solution (GAP solution GmbH, Leonding, A) [2]**



TLM - Daylight measurement sensor



View of sky with Fish-Eye Sky Cam

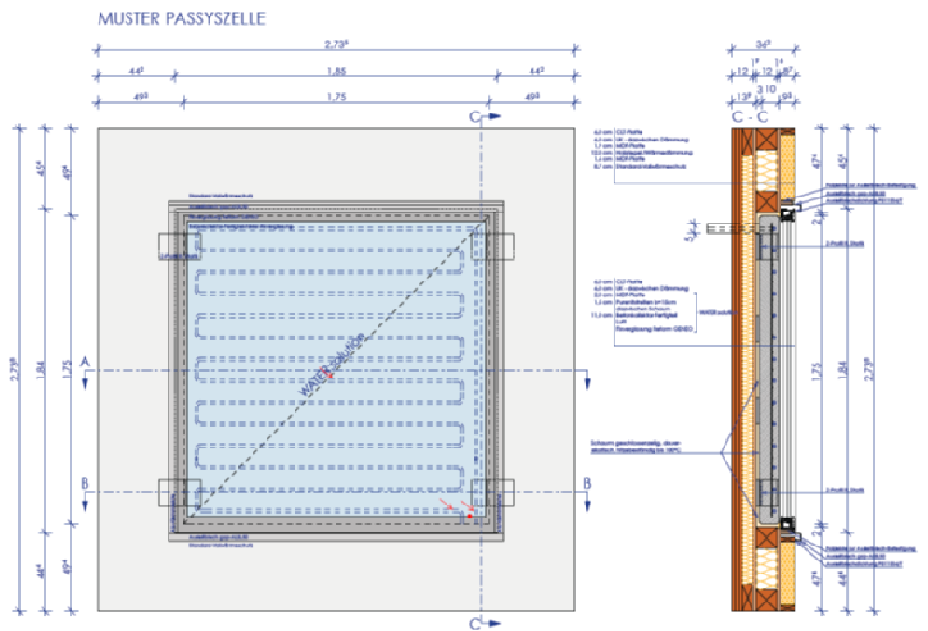

Section C-C (left) and vertical section (right) of the water: solution component

The component under investigation is a solar absorber made of concrete mounted in an insulated timber construction. Within the concrete absorber, a



stainless steel tube is integrated for solar preheating of domestic hot water. To be able to test this system, additional hydraulic and monitoring equipment had to be installed for testing of active components. In addition to the passive and active performance of the system, tested in the PAS test cell, the acoustic behaviour was measured in the acoustic testing facility at the UIBK test site as well.

## Indoor air flow distribution measurements

### Example 5: FFG-project low\_vent.com [7]

In this project a test cell was used to measure the air exchange efficiency for a certain floor plan configuration. The study investigated the so called extended cascade ventilation (no supply air in the living room). The PAS test cell provided quasi-adiabatic conditions to measure a potential short circuit flow between opposing overflow elements for various temperatures.

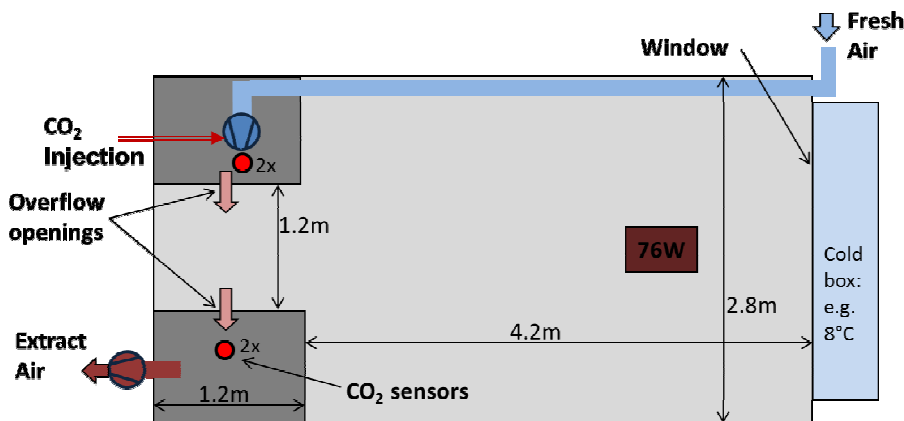

Schematics showing the experimental set-up measuring the air exchange efficiency Reprinted from [7], with permission from Elsevier



Mounting of test component (Project water:solution)



Interior of test cell for measurement of the air exchange efficiency

## MAINTENANCE/ COLLABORATION

### Personnel involved

The test facility is maintained by employees of TVFA and research persons of University Innsbruck. They are also responsible for data analysis and take care of smaller adaptations. The maintenance of the heating and cooling system is done by Sparerer Klima&Kältetechnik.

### Link with other devices

The outdoor test facility as well as the indoor climate chambers and sound measurement test devices are part of the TVFA (Technische Versuchs und

Forschungsanstalt) working as an accredited laboratory of the University Innsbruck. The test cells work as a stand-alone test facility, the data acquisition is located in an office container nearby, a fast data transfer by fibre optic cable is established.

## RELEVANT LITERATURE

### Literature on previous measuring campaigns:

[1] Pfluger, Rainer; Malzer, Harald; Feist, Wolfgang: Testing of a Window Device with Integrated Shading and Ventilation System with PAS-test cell and Coldbox, in: Bloem, Hans et al. (2010) DYNASTEE workshop on Dynamic Methods for Building Energy Assessment Centre Borchette Brussels, 11-12. October, 2010

[2] Hauer, Norbert; Neyer, Daniel; Richtfeld, Richtfeld; Streicher, Wolfgang: WATER-Solution, Evaluierung der Freifeldversuche, Ableitung eines Excel-Tools für die Ertragsprognose, Universität Innsbruck, AB Energieeffizientes Bauen, 12. Nov. 2014

[3] Ochs, Fabian; Dermentzis, Georgios; Siegele, Dietmar; Konz, Alexandra; Feist, Wolfgang: Façade integrated active components in timber-constructions for renovation - a case study. NSB 2014, Lund, SE

[4] Ochs, Fabian: Facade-integrated MVHR with Speed-controlled Micro-heat Pump; Fabian Ochs, Dietmar Siegele, Georgios Dermentzis, Wolfgang Feist, ICR 2015, Japan (accepted)

[5] Ochs, Fabian; Dermentzis, Georgios; Siegele, Dietmar; Feist, Wolfgang: Modelling, testing and optimization of a MVHR combined with a small-scale speed controlled exhaust air heat pump, Building Simulation Applications, BSA 2015, 2. IBPSA Italy Conference, Bolzano, Italy, 2015.

[6] Siegele, Dietmar: Measurement and Simulation of the Performance of a Façade-integrated MVHR with Micro Heat Pump, Master Thesis, University of Innsbruck, 2015.

[7] Rojas, Gabriel; Pfluger, Rainer; Feist, Wolfgang: Cascade ventilation - Air exchange efficiency in living rooms without separate supply air, Energy and Buildings. (2015). DOI: 10.1016/j.enbuild.2015.02.014

# VLIET TEST-BUILDING KU LEUVEN



## GENERAL DESCRIPTION

### Main objective of the test facility

The VLIET-testbuilding at K.U.Leuven is a full scale test facility, constructed in 1996, for the comprehensive study of the hygrothermal behavior of well insulated building components under ‘real’ outside climate conditions.

The building is designed as a long box, with test walls in the longitudinal facades, facing southwest, and northeast. In this way similar test parts can be directed towards the southwest and the north east direction. In Flanders, the southwest direction is warm and wet, the north east cold and dry. If not completely air tight, building elements in the south west façade mainly show air infiltration, in the north east exfiltration. By testing the same elements in both directions, information is gained about the climatic influences on the hygrothermal behavior.

### Institute/organisation:

**KU LEUVEN**

Building Physics Section  
Department of Civil Engineering  
KU Leuven, Belgium

### Contact person:

Prof. Staf Roels  
Kasteelpark Arenberg 40  
B-3001 Heverlee Leuven  
BELGIUM  
tel: 32(0)16321349  
staf.roels@bwk.kuleuven.be

### Exact location:

Heverlee, Leuven, Belgium  
50.88° N, 4.7° E

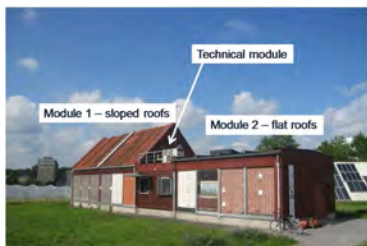

Overall view of the building with the two modules indicated.



Picture during construction of building elements: the measurement bays with fill in masonry for test walls and the construction of test roofs are visible.



Inside view; an airtightness test is performed on one of the facade elements.

## Overall lay-out

The test building is divided in two modules, in which a different inside climate can be installed. The module at the south east side contains measuring bays for 8 test walls (four at north east side, four at south west side) and for four flat roofs. The module at the north west side is larger and provides measuring bays for 12 walls (six south west, six north east) and six duo pitched roofs. In between the two modules, the room for the air conditioning and central logging is placed and a small additional testroom at the south west side for the applications of passive solar energy, solar shading devices,...

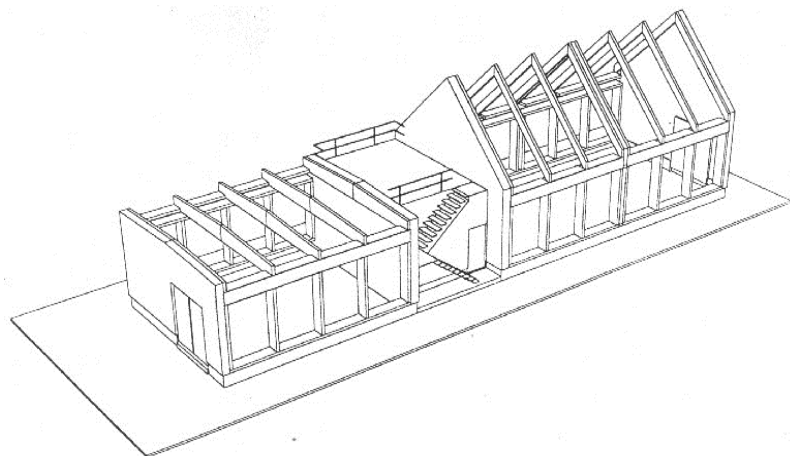

*Perspective view of the fixed structure of the test building. Metal structure + measurement bays separation in wood-PUR-wood*

The overall building size (25.2 meter long by 7.2 meter wide) is based on the dimensions of the test walls and roofs. To make the test parts representative of real envelope parts, sufficiently large measuring bays are foreseen. The width of each bay is 1.8 meter. The wall bays are one storey high (2.7 meter), the roof bays are 3 meter long in horizontal projection.

## Inside boundary conditions

Temperature, humidity and air pressure are the determining parameters for the inside climate. The HVAC-system of the test facility is designed in such a way that both residential as fully conditioned climates can be simulated. In Belgian dwellings, the installation often only adjusts the temperature through heating. Humidity and air pressure depend on the outside climate and inhabitants behavior. In offices, hospitals, factory buildings,... the installation system often controls all three parameters. In this case, the temperature is limited by heating and cooling, humidity is adjusted and an active air pressure difference is imposed between inside and outside.

## PART 1: Facilities for outdoor testing of building components

The HVAC-system allows imposing different inside conditions in the two modules. This is realized by a double air conditioning system. A ventilation fan, located in the installation room, is injecting air through a duct in the axis of each module. The air consists of a mixture of outside air and recirculation air, that is heated and humidified. When dwelling conditions are simulated, the ventilation rate is fixed to a certain volume per hour. In this case, local humidifiers with constant evaporation rate within each module simulate moisture production.

### Outside boundary conditions

As the building is designed to study the hygrothermal behavior under real climatic conditions, the outside climate is present just as it is in real field measurements. The outside conditions are measured with a local weather station (temperature, relative humidity and solar radiation on the roof of the installation room) and wind mast with ultrasonic anemometers in front of the building. In addition the driving rain in the free field in front of the building and at several location of the building façade is continuously logged.

### Special limitations / possibilities

Apart from the study of the hygrothermal performance of highly insulated building components, the VLIET-test building has also extensively been used for an in depth study of driving rain loads on buildings. To do so, the building has been equipped with a horizontal driving rain gauge in the free field in front of the building and several driving rain gauges at the façade. The measured driving rain load at the different positions has been compared with numerical predictions making use of computational fluid dynamics.

Recently a test building within the test building has been constructed that connects a measuring bay at the south west façade with a bay at the north east façade, simulating a row house. In this way the influence of the properties of one façade on the hygrothermal response of the other façade can be investigated. This is for instance of major importance when looking at air transport within the row house and through the façade elements.

In 2011, a full scale test room was constructed to allow a detailed study of the airflow distribution in the room and the thermal behavior of the constructive elements during f.i. night ventilation. The test room is located in the north-west corner of the building, with the façade facing south-west. The room dimensions are 1.83 m wide, 3.45 m long and 2.4 m high. A window is placed centrally in the façade, containing a hopper window, which can be opened automatically to a maximum opening angle of 30°. The window is integrated in the façade to allow easy replacement by other window types. In the opposite wall, an outlet opening is placed, with dimensions of 1 m wide and 0.1 m high at 20 cm from the ceiling. The outlet opens into a metal plenum box, connected to an extraction fan. A valve was placed in the exhaust channel, before the extraction fan, over which the pressure difference is measured. The valve has 7 opening sizes, but must be controlled

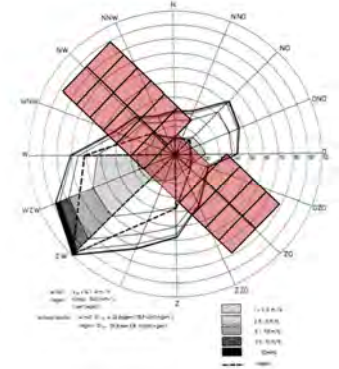

The building is oriented in such a way that similar test parts can be tested southwest (warm and wet side) and north east (cold and dry)



Wind mast in front of building with cup anemometers at three heights and ultrasonic anemometer in order to determine the wind velocity profile.



Driving rain gauge at one of the facades of the test building to study the driving rain impact on buildings.

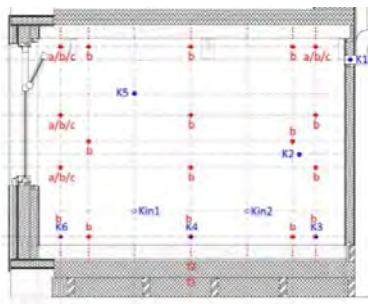

Cross section of full scale test room

manually. An exhaust opening is made in the NW-façade of the building and is provided with a wind shield. The room side wall bordering on the buildings NW façade is fully opaque. The opposite inner wall has been provided with two large windows covering most of the surface, and containing a glass door. They were integrated such that the full floor to ceiling height is visible through the glass.

The floor and ceiling consist of a 15 cm thick concrete slab, supplied with 59 thermocouples each at three different depths. Despite the different structural demands, the floor and ceiling slab have an identical composition. Rebar of 150x150x6mm was placed at the top and bottom of each plate, respecting a minimum concrete cover layer of 15 mm. Two circuits of electrical heating cable were placed at depths 40 and 110 mm, with 86 W/m<sup>2</sup> of heating power in each of the four layers. In between the loops 21 thermocouples were placed. At the center plane of each slab, a concrete core activation tube of 17 mm diameter was placed, at a core to core distance of 150 mm. A set of 17 thermocouples were placed in this layer, 6 of those monitoring the tube temperature. Furthermore, nine heat flux meters are distributed over the floor surface, and seven are glued on the ceiling surface, with highest resolution close to window and outlet.



Full scale test room during construction: concrete floor and ceiling, window in SW façade, windows in room side wall

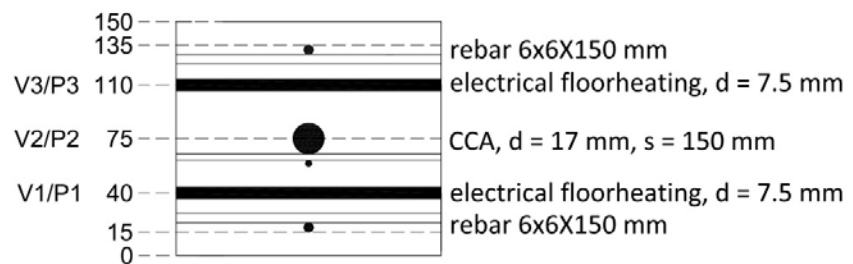

## DATA ANALYSIS

### Typical equipment within test wall



Measurement equipment at different heights and different interfaces in the building components.

The lay-out of the measuring equipment within each test wall is always a compromise between two conflicting demands. On the one hand, enough measuring points have to be installed to all important information on the distribution of a certain variable is available, on the other hand, each additional data point leads to an increase of the costs of data and computer equipment and efforts to processing and interpretation of the data. Furthermore, too many measuring equipment may influence the hygrothermal behavior.

## PART 1: Facilities for outdoor testing of building components

In the VLIET-building the majority of the measurements is done by automatically and continuously logging by a computerized datalogger system. For a typical envelope part, the measuring equipment consists of the following sensors: heat flux sensors, thermocouples, relative humidity sensors and air pressure tubes.



Data logging of the building elements: all sensors are connected to the logger via plug-in-cards.

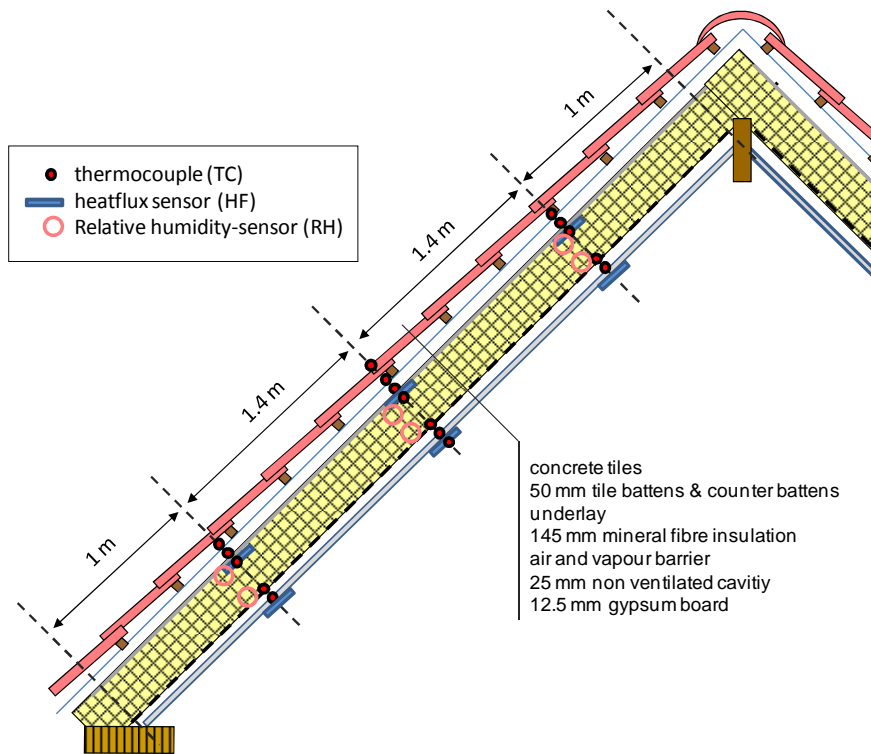

Typical configuration of a test roof with the sensor assembly indicated on the left part: the temperatures and heat fluxes are measured at three heights along each roof.

To achieve maximal flexibility when building components have to be adapted, the data logging of the measurement equipment is designed in such a way that all sensors are connected to plug-in-cards. The connection between the plug-in card and the logger is fixed, only the connection sensor-plug in card is changed when the walls are changed.

In addition to the continuous logging of temperatures, relative humidity, heat fluxes, ... specific measurements are performed to determine the global properties of the building elements. With an adapted blowerdoor equipment the airtightness of the building components can be evaluated and with a semi Hot Box that fits the measuring bays the overall U-value can be determined.

### Accuracy and logging resolution

The logger is connected to the central computer, measuring all sensors every 10min.



Semi Hot Box fitting a wall measurement bay in order to measure the overall U-value

## Specification and accuracy of sensors and measuring instruments:

Instrument	Manufacturer	model	Measurement range	accuracy
Thermocouple (type T)	Thermo-electric Belgium	P-26-TT-IEC	Max. 105°C	± 0.1°C
Relative humidity sensor	Honeywell, Belgium	HIH-4000	0-100 %	± 0.5%
Heat flux sensor	Hukseflux Thermal sensors, The Netherlands	HFP01	-2000 to 2000 W/m <sup>2</sup>	± 5% of readings
Pressure sensor	Halstrup walcher GmbH, Germany	P92	0-25Pa	± 4% of readings
Velocity sensor (Hot wire anemometer)	TSI incorporated, U.S.A.	Model 8475	0.05-2.5m/s	± 3% of readings

## Analysis of the data

Data analysis is strongly depending on the investigated issue; relative humidity course, risk on interstitial condensation, moisture content of different layers,..

With respect to the thermal performance, the thermal resistance (and corresponding U-value) is based on measurements with the adapted semi hot box (see description and picture above) or determined from measured heat fluxes and temperatures. In the latter case, the concept of “local apparent thermal resistance” is introduced as the traditional thermal performance indicators (U-factor (W/(m<sup>2</sup>K) and thermal resistance R-value (m<sup>2</sup>K/W)) are only defined for pure heat conduction, while the measured values are also influenced by air looping, wind washing and dynamic effects. The local apparent thermal resistance is determined mainly based on simple, straightforward techniques as linear regression or averaging technique.

## EXAMPLES OF PREVIOUS STUDIES

Since 1996 the VLIET-testbuilding has been used to study the hygrothermal performance of all kind of building components; both walls and roofs. Most of the time highly insulated components have been studied, but the focus was seldom only on the thermal performance. Most of the time durability aspects (hygrothermal degradation) was part of the research. Examples of previous studies are:

- Hygrothermal behavior and corrosion of flat zinc roofs
- Study of the effect of a ventilated cavity on the durability of fibre cement cladding systems



- Robustness of highly insulated masonry cavity walls
- Analysis of the advantage/disadvantage of ventilated/vented sloped roofs
- Hygrothermal behavior of masonry walls with exterior Insulation systems and outside rendering
- The effect of reflective foils in sloped roofs
- The effect of reflective foils in light weight building walls
- Rain load and rain water penetration in glued masonry veneers
- Analysis of historic masonry walls containing salt
- Hygrothermal behavior of masonry walls renovated with interior insulation systems
- Thermal performances of double skin facades
- Shading performances of vertical and horizontal louvre systems

## MAINTENANCE / COLLABORATION

### Personnel involved

The building is maintained by the technical staff of the Building Physics Section of K.U.Leuven. They are also responsible and in charge for all adaptations, new measuring campaigns, etc. in collaboration with the responsible engineering or researcher. The latter also performs the data analysis.

### International collaboration

There is no specific international collaboration with respect to the device. During construction phase there has been close contact with IBP (Fraunhofer) and other institutes with similar devices.

### Link to other devices

The study of the hygrothermal behaviour of building components under “real” climatic conditions as performed in the VLIET-testbuilding is one element in the overall investigation of the physical behavior of heat, air and moisture-effects in highly insulated building components. In addition to the field measurements in the VLIET-building the Building Physics Section of K.U.Leuven investigates specific aspects of the hygrothermal behavior in a ‘hot-box / cold-box apparatus’.

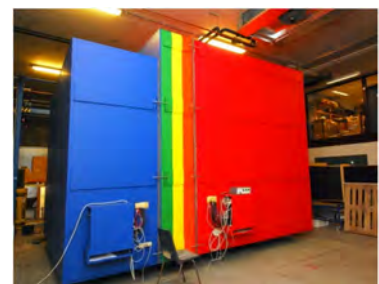

Hot Box / Cold Box apparatus to study building components under controlled boundary conditions in the laboratory.

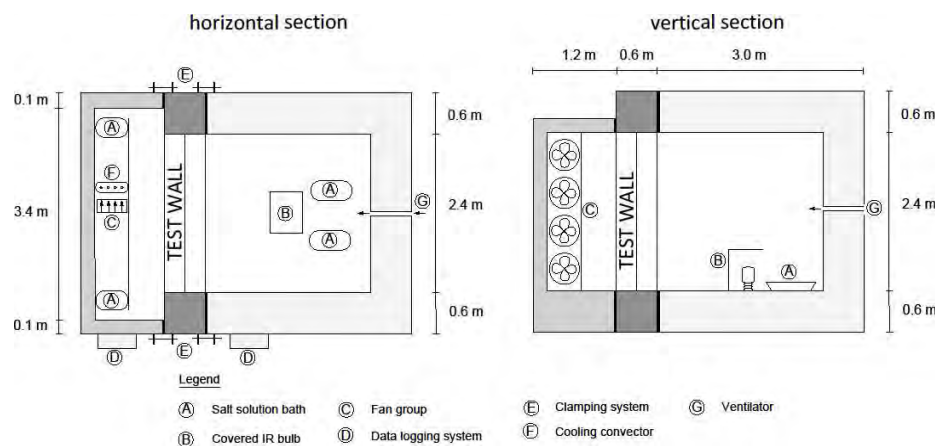

*Overall view of the hot-box / cold-box apparatus at K.U.Leuven in addition to field measurements in the VLIET test building*

Here, the building elements can be studied under well controlled constant or periodic boundary conditions. This provides additional insight in partial aspects, such as energy consumption, risk on interstitial condensation, effects of controlled air flow patterns,... Because of the controlled boundary conditions, hot-box / cold-box measurements are also adequate validation tools for numerical models. Once validated the numerical codes are powerful instruments to come to a better knowledge of the hygrothermal behavior of building components.

## RELEVANT LITERATURE

### General literature about the test facility:

Janssens A, Hens H, Roels S, VLIET-proefgebouw (VLIET-testbuilding), information document at the inauguration of the testbuilding, 1995.

Annual reports of the first four years of the VLIET testbuilding (1996-1999) according to the funding agreement with IWT VLIET/930235.

### Literature on previous measuring campaigns:

Hens H, Janssens A, Zheng R, 2003. Zinc roofs: an evaluation based on test house measurements. *Building and Environment* 38, 795-806.

Saelens D, Roels S, and Hens H, 2004, The inlet temperature as a boundary condition for multiple-skin facade modelling, *Energy and Buildings*, vol. 36, pp. 825-835.

## PART 1: Facilities for outdoor testing of building components

Janssens A, Hens H, 2007. Effects of wind on the transmission heat loss in duo-pitched insulated roofs: a field study. *Energy and Buildings* 39(9), 1047-1054.

Abuku M, Blocken B, Roels S, 2009. Moisture response of building facades to wind-driven rain: field measurements compared with numerical simulations. *Journal of Wind Engineering and Industrial Aerodynamics* 97, 197-207.

Zheng R, Janssens A, Carmeliet J, Bogaerts W, Hens H, 2010. Performances of highly insulated compact zinc roofs under a humid-moderate climate - Part I: hygrothermal behaviour. *Journal of Building Physics* 34(2), 178-191.

Roels S, Deurinck M, 2011. The effect of a reflective underlay on the global thermal behaviour of pitched roofs. *Building and Environment* 43, 134-143.

Zeridun Desta T, Langmans J, Roels S, 2011. Experimental data set for validation of heat, air and moisture transport models of building envelopes. *Building and Environment* 46(5), 1038-1046.



## FIELD EXPOSURE OF WALLS FACILITY



### GENERAL DESCRIPTION

NRC-IRC's Field Exposure of Walls Facility (FEWF) is located in Research House no. 3 at the NRC Montreal Road campus in Ottawa. The facility is used to assist the building industry in developing integrated solutions by providing opportunities for the characterization of the hygrothermal performance of innovative wall systems and retrofit strategies. Researchers can examine the comparative performance of different side-by-side wall assemblies exposed to naturally fluctuating outdoor climate and controlled indoor conditions of relative humidity, temperature and pressure. The data is used to benchmark hygrothermal modeling simulations using hygIRC 1D, and hygIRC-C (3D) for opaque walls. hygIRC-C is also used to assist the design, commissioning and analysis the experiments and results from the FEWF.

**Institute/organisation:**



National Research Council Canada  
Institute for Research in Construction

**Contact person:**

Dr. Wahid Maref  
1200 Montreal Road, Bldg M24  
Ottawa, Canada  
tel: 613-993-5709  
e-mail [wahid.maref@nrc.cnrc.gc.ca](mailto:wahid.maref@nrc.cnrc.gc.ca)

**Exact location:**

Ottawa, Canada  
45° 26'N, 75° 37'W

### Overall lay-out



Three test bays in preparation.



Test bays nearing completion.

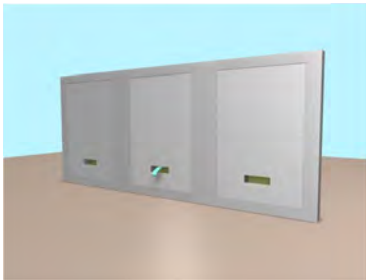

Slits in air barrier and wood sheathing allow exfiltration and infiltration.



Enclosure for control of interior Temperature, RH, and pressure.

The first floor of the West facade of the research house includes a test bay measuring 7.5 m wide by 3.2 m high test. It can accommodate one large specimen or several narrow specimens – typically 3 test bays per experiment – see Figure 1. Each bay is separated thermally with an insulated instrumentation cavity. Each experiment requires the full removal of the test bay and complete reconstruction, and re-instrumentation. Experiments typically last a full year. Wall specimen dimensions are not restricted to one size. Lightweight wood frame walls and massive wall specimens (e.g. insulating concrete form walls) have been studied.

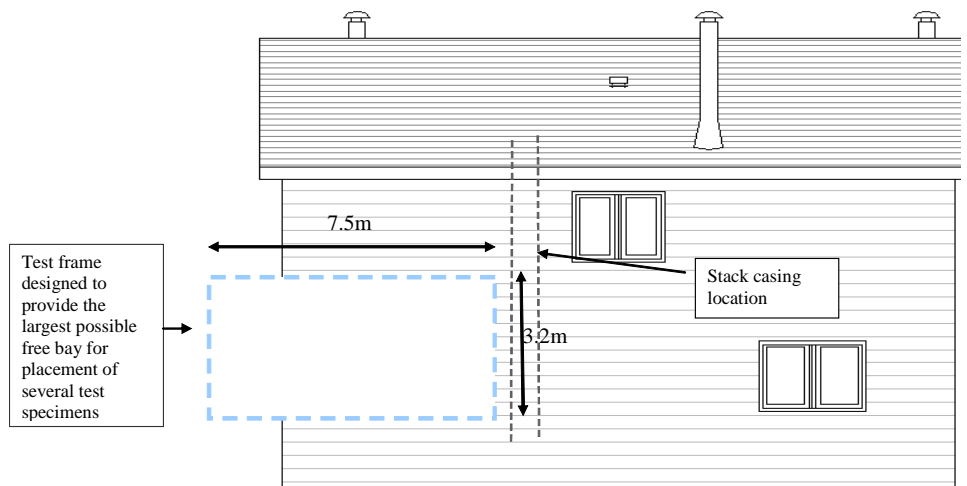

Figure 1. Schematic of the Field Exposure of Walls Facility (FEWF).

### Inside boundary conditions

To investigate the effects of an increase of indoor humidity levels on moisture content of wood-based materials, an indoor climatic chamber was constructed to introduce high humidity and increased air pressure levels on the interior side of Walls 2 and 3. Wall 1 was kept as a control wall, and exposed to uncontrolled indoor room conditions (i.e. low RH in winter). Pressure, humidity and temperature conditions were regulated and monitored throughout the field trial in the indoor climatic chamber.

As example the different walls were subjected to varying indoor conditions of relative humidity and pressure during the winter season. Four periods were selected for intensive analysis (labeled A to D respectively), as described in Table 1. To explore the potential for wetting and drying when varying the degree of air leakage across the wall assembly, the specimen air leakage characteristics were modified during testing to represent two levels of increased leakiness as compared to a perfectly airtight assembly.

Condition	Indoor Climatic Chamber		Opening in the air barrier system and drywall	Test period (2007)	Range of Outdoor T (°C)
	Pressure (relative to room air)	RH			
A	0 Pa	70%	None	11 Feb – 18 Feb	-24.5 to -3.3
B	5 Pa	50%	6 X 400 mm	22 Feb – 24 Feb	-14.3 to -4.6
C	5 Pa	~30%	3 X 400 mm	16 Mar – 17 Mar	-10.0 to -4.4
D	0 Pa	50%	3 X 400 mm	8 Apr – 15 Apr	-6.4 to 6.3

Table 1. Example of test schedule of different indoor and outdoor conditions.

## Outside boundary conditions

A rain gauge measuring the quantity of rainwater deposition in one area of the exterior face of the exterior siding is in place as well. Ambient outdoor parameters including temperature, relative humidity, wind speed and direction are measured by means of a weather station located 30 m from the research house.

## Special limitations / possibilities

This flexible state-of-art research house enables not only evaluate the in-situ hygrothermal performance of exterior wall assemblies that have different wall assembly techniques, insulation systems and air and vapour barrier approaches, but enables as well comparison of various heating and ventilation strategies while evaluating energy usage and the quality of the resulting indoor environment. It also allows side-by-side rooms comparison in term of energy conception and thermal comfort. Automated 3-D indoor environment measurement systems (robots) are used to sample spatially distributed indoor environment parameters. The walls are exposed to the indoor conditions of the house and therefore will offer an opportunity to investigate interactions between wall moisture performance and indoor conditions produced by the various heating and ventilation systems.

## DATA ANALYSIS

### Typical equipment within test wall

Several monitoring instruments were used to characterize hygrothermal response in the different layers of the wall assembly. The middle stud cavity was designed to be the focus of the study, with the stud cavities on either side acting as a buffer zone. For this reason the majority of instrumentation was located in the middle stud of each wall, as shown in Figure 2. The instrumentation was deployed at four heights (Figure 3), with most sensors concentrated in the large area below the gap in the exterior sheathing - where it was assumed moist air exfiltration would lead to wetting.

Pressure sensors installed in the test specimens measured the differential air pressure between the pressure taps, at locations shown in Figure 2, and the ambient room pressure. Pressure taps were located in the top half of the middle stud cavity, 254 mm (10 in.) above the gap in the exterior sheathing.

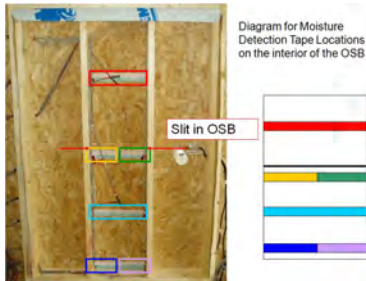

Moisture detection strips to track the path of condensation at the inner surface of the wood sheathing.

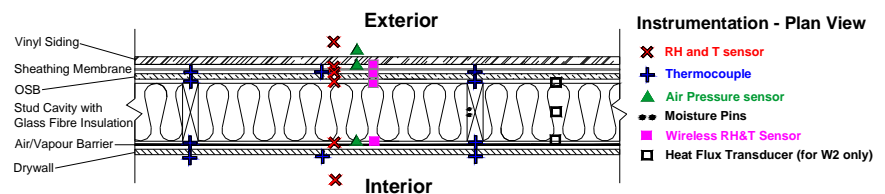

Figure 2. Plan view of wall cross section



Surface moisture detection strips and moisture pins.



Heat flux transducers.

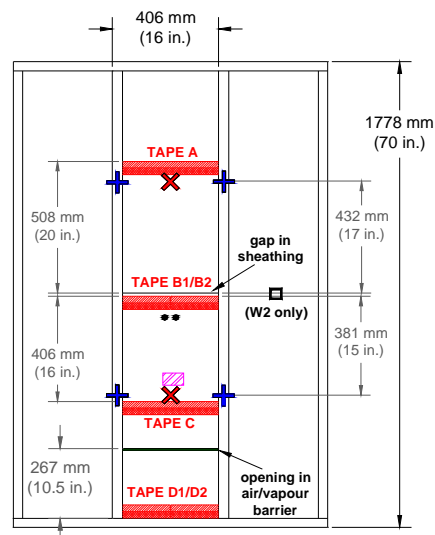

Figure 3. Liquid moisture detection strips.

Additionally, researchers deploy sensors of moisture content of wood-based materials and liquid moisture detectors on the surface of building materials in different internal layers of the wall specimens.



## Accuracy and logging resolution

All sensor data is recorded at a 15-minute interval. Temperature was measured with an accuracy of  $\pm 0.1^{\circ}\text{C}$ , while relative humidity measurements were accurate to  $\pm 0.5\%$ . The uncertainty of the heat flux measurements was  $\pm 5\%$ .

Instrument	Manufacturer	Model	Measurement Range	Accuracy
Thermocouple (Type T)	Omega	TT-T-24-SLE	Max 200°C	$\pm 0.1^{\circ}\text{C}$
Relative Humidity	HoneyWell	HIH 3602C	0-100%	$\pm 0.5\%$
Heat Flux	HuksefluxUSA Thermal Sensors	PU11-T & PU32-T	-2000 to 2000 $\text{w/m}^2$	$\pm 5\%$ of readings
Pressure Sensors	Setra	0.25"WC and 2.5"WC	Max 0.25" WC and 2.5"WC	$\pm 1\%$ full scale

Table 2. Instrumentation accuracy.

## Analysis of the data

The experimental methodology and instrumentation provided substantial insight into the hygrothermal performance of wall assemblies under varying conditions. The deployment of water detection tape proved valuable in confirming or not the presence of surface water at different layers through the wall when temperature and humidity conditions were favorable for condensation. The resulting wealth of data will aid in benchmarking numerical models, and in characterizing the response of the exterior walls to heat, air and moisture transfer.

## EXAMPLES OF PREVIOUS STUDIES

Since 2006 the FEWF has been used to study side-by-side hygrothermal performance of wall assemblies. The most of the study focused on the effects of the different envelope characteristics on interstitial moisture accumulation. Examples of previous studies are:

1. Year 1 (2006-2007) Commission the facility by monitoring three identical test specimens of traditional construction (2x6) through Fall, Winter and Spring.
2. Year 2 (2007-2008) Partnership with Canada Mortgage and Housing Corporation (CMHC) and Natural Resources Canada (NRCan) to investigate the effects of two energy retrofit strategies on the wetting and drying potential of wall assemblies.
3. Year 3 (2008-2009) Partnership with FPIInnovation (Forintek) to investigate the effects of the interior air/vapour barrier polyethylene membrane on the wetting and drying potential of wall assemblies and extending the project with CMHC & NRCan for one retrofit strategy.

4. Year 4 (2009-2010) Partnership with CMHC & NRCan to investigate the dynamic heat transmission characteristics through Insulated Concrete Form (ICF) wall assemblies over a full year cycle of weather exposure.
5. Year 5 (2010-2011) Project to Test the Next Generation Envelope Systems (i.e. Vacuum Insulated Panel) in partnership with CMHC and NRCan.
6. Year 6 and beyond Investigate the performance of wall specimens of different innovative designs based on industrial collaboration/partnership.

## MAINTENANCE / COLLABORATION

### Personnel involved

The Research House is maintained by Technical staff and Managed by Research Officers of the National Research Council Canada's Institute for Research in Construction (NRC-IRC) from two programs: Indoor Environment (IE) and Building Envelope and Structures (BES).

### International collaboration

There is currently no specific international collaboration. The facility is currently used in partnership with industry and with other Canadian Government Agencies.

### Link with other devices

The study of hygrothermal behaviour of building envelopes under real climatic conditions as performed in the FEWF is one of the facilities of the Heat, air and Moisture Performance of Envelope (HMPE) group. In addition to the field measurements HMPE investigates specific aspects of thermal behaviour of wall systems in the Guarded Hot Box apparatus as well at the Environmental Exposure Envelope Facility (EEEF) climatic chamber and Dynamic Wall Test Facility (DWTF) for water penetrations. In these facilities, the building envelope is subjected to controlled boundary conditions (Interior and Exterior). This will give better insight of the interstitial condensation and hygrothermal performance. The measurements are used to benchmark the State-of-The-Art hygrothermal CFD package tool hygIRC-C developed by NRC-IRC. For whole-house energy and moisture assessment studies, the team also collaborates with the Canadian Centre for Housing Technology (CCHT), operated as a partnership between National Research Council Canada, Canada Mortgage and Housing Corporation and Natural Resources Canada.



Envelope Environmental Exposure Facility (EEEF)



Twin Houses at the Canadian Centre for Housing Technology

## RELEVANT LITERATURE

### General literature about the test facility:

- Client Report “Evaluating The effects of Two Energy Retrofit Strategies For Housing on The Wetting and Drying Potential of Wall Assemblies”, W. Maref, M. Rousseau, M.A. Armstrong, W. Lei, M. Leroux and M. Nicholls, Nov 2009, PP 1-118.
- Client Report “The dynamic heat transmission characteristics through Insulated Concrete Form (ICF) wall assemblies over a full year cycle of weather exposure”, W. Maref, H. Saber, M.A. Armstrong, M.Z. Rousseau, C. Thivierge, G. Ganapathy, M. Nicholls, F. Lalumiere and K. Abdulghani, 2011.
- Client report “Effects of the Interior Air/Vapour Barrier Polyethylene Membrane on the Wetting and Drying Potential of Wall Assemblies”, W. Maref, M.Z. Rousseau, M.A. Armstrong, C. Thivierge, G. Ganapathy, M. Nicholls, F. Lalumiere and K. Abdulghani, 2011, PP 1-100

### Literature on previous measuring campaigns:

- **Field Monitoring of Wetting and Drying in Wood-Frame Walls of Different Interior and Exterior Heat, Air and Vapour Transmission Characteristics for a Cold Climate Windows**, W. Maref, M. Armstrong, M.Z. Rousseau, C. Thivierge, M. Nicholls, G. Ganapathy and W. Lei, Submitted to ASTM Journal, 2010.
- **Hygrothermal Response of Different Wall Assemblies to Water Ingress**, C. Thivierge, W. Maref, M. Armstrong, G. Ganapathy, M. Nicholls and M.Z. Rousseau, Submitted to 13<sup>th</sup> Canadian Conference of Building Science and Technology, May 2011, Winnipeg, Canada.
- **Field Monitoring of Wetting and Drying in Wood Frame Wall Assemblies in Cold Climate**, W. Maref, M. Armstrong, M.Z. Rousseau, C. Thivierge, M. Nicholls and W. Lei, Submitted to 13<sup>th</sup> Canadian Conference of Building Science and Technology, May 2011, Winnipeg, Canada.
- **Field Energy Performance of an Insulating Concrete Form (ICF) Wall**, M. Armstrong, H. Saber, W. Maref, M.Z. Rousseau, G. Ganapathy and M.C. Swinton, Submitted to 13<sup>th</sup> Canadian Conference of Building Science and Technology, May 2011, Winnipeg, Canada.
- **Benchmarking 3D thermal model against field measurement on the thermal response of an insulating concrete form (ICF) wall in cold climate** Saber, H.H.; Maref, W.; Armstrong, M.M.; Swinton, M.C.; Rousseau, M.Z.; Ganapathy, G. Eleventh International Conference on Thermal Performance of the Exterior Envelopes of Whole Buildings XI (Clearwater, (FL), USA 2010-12-05) pp. 1-21. .
- **Field monitoring of energy-retrofitted wall assembly in cold climate: impact of the vapour permeance of exterior retrofit insulation on the flow of moisture in wood-frame wall** Maref, W.; Armstrong, M.M.; Rousseau, M.Z. ASHRAE Seminar no. 48 on "Solving

- Moisture Problems Created by Energy Efficient Design" (Albuquerque (NM) USA 2010-06-30)
- **Effect of the air and vapor permeance of exterior insulation on the flow of moisture in wood frame walls in a cold climate** Armstrong, M.M.; Maref, W.; Rousseau, M.; Lei, W.; Nicholls, M. ICBEST 2010 - International Conference on Building Envelope Systems and Technologies (Vancouver, Canada 2010-06-27)
  - **A field monitoring investigation of the effect of adding different exterior thermal insulation materials on the hygrothermal response of wood-frame walls in a cold climate** Maref, W.; Armstrong, M.M.; Rousseau, M.Z.; Lei, W. BEST2 Conference (Building Enclosure Science & Technology) (Portland, (OR), USA 2010-04-12) pp. 1-15.
  - **Workshop on Moisture Management and Energy Rating in Building Envelopes / Part II : Effects of two energy retrofit strategies on the wetting and drying potential of wall assemblies** Maref, W.; Armstrong, M.M.; Rousseau, M.Z. 12th Canadian Conference of Building Science and Technology (Montreal, QC 2009-05-06)
  - **A field monitoring study of interstitial condensation in wood-frame walls in cold climate** Armstrong, M.M.; Maref, W.; Rousseau, M.Z.; Lei, W.; Nicholls, M. 12th Canadian Conference on Building Science and Technology (Montréal, Quebec 2009-05-06) pp. 1-12.
  - **Effects of exterior insulation retrofit on moisture accumulation in wood-frame exterior walls (Poster)** Rousseau, M.Z.; Maref, W.; Leroux, P.; Armstrong, M.M. pp. 1. 2008-10-01
  - **Recent experiments conducted in NRC-IRC moisture management facility** Rousseau, M. Z.; Maref, W.; Armstrong, M.M.; Lei, W.; Nicholls, M. *Construction Innovation*, 13, (3), pp. 7. 2008-09-01 Complete citation
  - **Étude sur la performance hygrométrique des murs menée dans une installation d'essais à l'IRC-CNRC** Rousseau, M. Z.; Maref, W.; Armstrong, M.M.; Lei, W.; Nicholls, M. *Innovation en construction*, 13, (3), pp. 7. 2008-09-01
  - **Characterization of the hygrothermal performance of wall systems** Maref, W.; Manning, M.M.; Rousseau, M.Z.; Lei, W. ASHRAE Seminar 29 - Moisture Management Concerns in Commercial and Residential Buildings (New York, USA 2008-01-21) pp. 1-83. 2008-01-21
  - **Ventilation and wall research house** Maref, W.; Ouazia, B.; Reardon, J.T.; Rousseau, M.Z. Performance of Exterior Envelope of Whole Buildings X Conference (Clearwater, Florida 2007-12-01) pp. 1-8. 2007-12-01
  - **New field testing facility at NRC-IRC offers opportunities for wall performance assessment** Maref, W.; Rousseau, M.Z. *Solplan Review*, (135), pp. 18-19. 2007-07-01
  - **Hygrothermal performance of wall assemblies** Maref, W.; Rousseau, M.Z.; Lei, W.; Manning, M.M.; Nicholls, M.; Nunes, S.C. *Construction Innovation*, 11, (4), pp. 5. 2006-12-01

# THE CUBE



## GENERAL DESCRIPTION

### Main objective of the test facility

The Cube is an outdoor full-scale test facility located near to the main campus of Aalborg University, Denmark. The Cube was built in the fall of 2005 with the following purposes, in the frame of IEA ECBCS ANNEX 43/SHC Task 34, Subtask E- Double Skin Façade: the detailed investigations of double-skin façade (DSF) performance and the development of empirical test cases for validation of various building simulation software

Though, the major aim of the test facility is the performance investigation of different façade solution.

Institute/organisation:



Division of Architectural  
Engineering  
Department of Civil Engineering  
Aalborg University, Denmark

Contact person:

Olena Kalyanova Larsen  
Sohngaardsholmsvej 57  
9000 Aalborg  
Denmark  
tel: +45 9940 8543  
ok@civil.aau.dk

Exact location:

Aalborg East, Denmark  
57.02° N, 10.0° E

### Overall lay-out

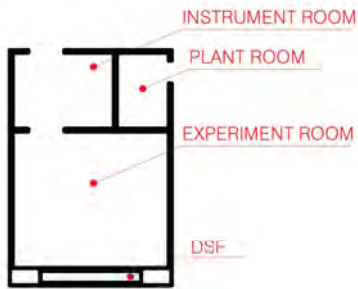

Plan drawing of the Cube



Southern facade of the Cube



Northern facade of the Cube



KE-low impulse fabric ducts in the experiment room



Ventilation system in the experiment room

The Cube consists of four domains, which are named as: double-skin façade (DSF), experiment room, instrument room and plant room. The experiment room together with the DSF represent the main building of the test facility, which has external dimensions of 6x6x6 metres. External dimensions of the plant and instrument room together is 6(w)x3x3 metres, which are attached to the northern wall of the experiment room.

The key measurements are carried out in the DSF and in the experiment room; meanwhile the instrument room and the plant room are used as a support zone. The instrument room is equipped with dataloggers and computers and the cooling system is installed in the plant room. In the experiment room, a ventilation system is set up for maintaining uniform conditions in the room.

The exact dimensions of the experiment room and double skin façade are summarized in the table below.

Zone	Width, mm	Depth, mm	Height, mm
DSF	3555	580	5450
Experiment room	5168	4959	5584

*Internal dimensions of the experiment room and double-skin facade*

Building geometry allows replacement of the double-skin façade by any other façade solution for testing. At the moment there is already another façade type has been installed.

The building is very well insulated and airtight.

### Inside boundary conditions

The boundary conditions in the experiment room are normally kept constant; meanwhile façade performance varies according to the outdoor conditions and/or control strategy. If necessary, it is possible to establish different from the described below constant inside boundary conditions.

Constant conditions: the temperature in the experiment room can be kept constant, due to ventilation system with the heating and cooling unit installed in the room. In order to avoid temperature gradients in experiment room, a recirculating piston flow with an air speed of approximately 0.2 m/s can be used for supply. The air intake for recirculation is at the top of the room. After the intake the air passes through the preconditioning units of the ventilation system and then it is supplied at the bottom of the room through fabric KE-low impulse ducts. Maximum power on cooling and heating units is 10 kW and 2 kW respectively. Humidity control is not present.

## PART 1: Facilities for outdoor testing of building components

Absorption, reflection and transmission properties of all surfaces in the experiment room were tested and available as a function of the wavelength, in the wavelength interval 250-2500nm.

### Outside boundary conditions

The Cube is a full-scale outdoor test facility, which is exposed to the real climatic conditions. It is located in open flat country, without any shield from wind and sun. The replaceable façade of the Cube is facing south in order to explore the maximum of solar radiation intensity. The outside conditions are measured with equipment placed locally at the test facility. Solar radiation is measured on the roof (global and diffuse) of the building and on the southern façade (total). The wind speed and wind direction are measured at 6 different heights above the ground on a wind mast in front of the building.

For reliable estimation of ground-reflected solar radiation, a large carpet is placed on the ground in front of the southern façade of the Cube to achieve uniform reflection from the ground. The fabric of the carpet was chosen so that it does not change its reflectance property when it is wet due to its permeability. Reflectance is approximately 0.1, close to the generally assumed ground reflectance.

### Special limitations / possibilities

Specific for the test facility is the possibility to replace the southern façade element. This allows performing experimental studies of any kind of façade solutions. Powerful cooling system allows maintaining necessary inside boundary conditions, but more importantly cooling and heating load to experiment room can be measured accurately. As a result, a complete heat balance can be determined for the experiment room and the façade element can be characterized in terms of solar and heat transmission.

## DATA ANALYSIS

### Typical equipment within test wall

Due to the flexibility of the test facility different façade elements can be tested. As a result the experiments are performed with different objectives and only few devices are used in the test facility as a standard. Standard equipment is used for measurement of outdoor boundary conditions, cooling and heating loads in the experiment room, surface and air temperature in the experiment room. These include thermocouples type K, 2D and 3D ultrasonic anemometers of 3 different types, Wilhelm Lambrecht and BF3 pyranometer on the roof of the Cube and Wilhelm Lambrecht pyranometer in the centre of

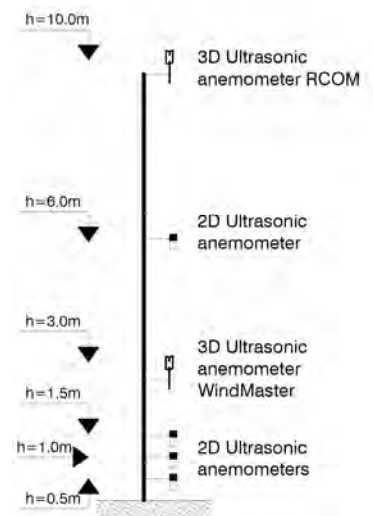

Positioning of equipment on the wind mast



3D ultrasonic anemometer



2D ultrasonic anemometer



Photo of pyranometers on the roof of the Cube, Wilhelm Lambrecht pyranometer at the left and BF3 at the right

southern façade. Air humidity is normally measured with COMARK data logger N2003.

Water is used in the cooling unit of the ventilation system. With the purpose to avoid the condensation on the surface of the cooling unit the minimum water temperature was set to 12°C. The difference between the supply and return water temperature from the cooling unit is measured as voltage in mV. The mass flow of the water supplied to the cooling unit is measured with a water flow meter MULTICAL from Kamstrup, which measures in a range from 0 to 1kg/s. Both the temperature difference and the water mass flow are logged by Helios data logger at a frequency 0.1Hz.

The heating unit in the ventilation system is rarely activated, as in the most of cases an additional heating load in the experiment room is generated by a fan from running ventilation system. For keeping a track on all loads to the experiment room, including the heating unit, all equipment in the room is connected to a wattmeter D5255S from producer Norma.

### Accuracy and logging resolution

The wind speed and wind direction measurement is carried out with the frequency of 5 Hz, meanwhile the other data is assembled at a frequency 0.1Hz. Measurement uncertainty of equipment in the test facility is given below.

<i>Measurement</i>	<i>Model/producer</i>	<i>Uncertainty</i>	<i>Range</i>
<i>Temperature Datalogger</i>	FLUKE HELIOS	+/- 0.07 °C	
<i>Solar radiation</i> Diffuse on horizontal surface	Delta-T Devices, BF3	+/- 10 %	1250 W/m <sup>2</sup>
Total on horizontal surface	Wilhelm Lambrecht	+/- 2%	1000 W/m <sup>2</sup>
Total on vertical surface	Wilhelm Lambrecht	+/- 3%	1000 W/m <sup>2</sup>
<i>Wind speed</i> 3D ultrasonic anemometers	Gill, Windmaster research R3	+/- 1%	30 m/s
2D anemometers	Ft. technologies Ltd.	+/- 4%	30 m/s
<i>Wind direction</i> 3D ultrasonic anemometers	Gill, Windmaster research R3	+/- 3°	0-360°
2D anemometers	Ft. technologies Ltd.	+/- 3°	0-360°
<i>Cooling/Heating Load</i> Supply and return water temperature difference	-	+/- 0.1°C	0.1- 1V
Water mass flow rate	MULTICAL, Kamstrup	+/- 0.1%	0-1 kg/s
Wattmeter	Norma, D5255S	+/- 0.1% (of readings)	

*Measurement uncertainty of equipment used in the experimental set-up.*



## Analysis of the data

The data analysis will only depend on experimental set-up and the goals set for the investigation.

## EXAMPLES OF PREVIOUS STUDIES

In 2006 the test facility was used for investigation of thermal performance of double-skin façade in connection with IEA ECBCS ANNEX 43/SHC Task 34. The measurements were performed for a naturally and mechanically ventilated double façade and resulted in a set of empirical data that can be used for validation of building simulation software.

The above described experiments included measurements of natural air flow rates in the ventilated air gap, velocity profiles in the gap, etc.

In 2008 these experimental results were expanded by measurements with application of shading device in the double façade cavity space.

At the moment the Cube has been modified for an experimental study of intelligent glazed facades. This project concerns the development and validation process of the adaptive façade used in ways to (1) fulfill move closer to the goal of zero energy buildings and (2) fulfill the different needs and demands from the occupants concerning indoor climate. The further goal of the project is to develop algorithms for implementation in thermal building simulation software as well as energy regulation software.



Present experimental set-up in the Cube. An intelligent façade (left), and unintelligent façade (right).

## MAINTENANCE / COLLABORATION

### Personnel involved

Technical staff at the department is responsible for the major changes at the test facility related to adjustments or geometry modification in the measurement campaign. The technical staff is supervised by researchers responsible for the project. The researchers are also responsible for installation, calibration and control of measurement equipment, as well as data acquisition and data analysis.

## International collaboration

There is no specific international collaboration.

## Link with other devices

The Cube is an outdoor full-scale test facility, which is very useful for experiments in a real environment. Though in some cases it is necessary to test and control some particular outdoor conditions. For these purposes a small and a large hot-box available in the laboratory can be used.

A small custom-made hot-box allows testing of smaller façade components (apx. 1.5x1.5m component size). Furthermore a large hot-box that is about to be completed, will allow testing of large façade components with approximate size of components 3.4x3.4 meter.

Besides above mentioned facilities there are a number of indoor full-scale rooms available in the laboratory.

# RELEVANT LITERATURE

## General literature about the test facility:

Kalyanova, O. & Heiselberg, P. 2008. Experimental Set-up and Full-scale measurements in the 'Cube'. Aalborg : Aalborg University. Department of Civil Engineering. 58 s. (DCE Technical Reports; 34).

Kalyanova, O. & Heiselberg, P. 2008 Final Empirical Test Case Specification: Test Case DSF100\_e and DSF200\_e. Aalborg : Aalborg University. Department of Civil Engineering. 45 s. (DCE Technical Reports; 33).

Kalyanova, O., Jensen, R. L. & Heiselberg, P. 2008. Data Set for Empirical Validation of Double Skin Facade Model. Proceedings of the 8th Symposium on Building Physics in the Nordic Countries: NSB2008, Nordic Symposium on Building Physics 2008. Rode, C. (red.). 1. Technical University of Denmark s. 151-158. 8 s. (DTU Byg Report; R-189).

## Literature on previous measuring campaigns:

Kalyanova, O., Jensen, R. L. & Heiselberg, P. 2007. Measurement of Air Flow Rate in a Naturally Ventilated Double Skin Façade. Proceedings of Roomvent 2007: Helsinki 13-15 June 2007. Seppänen, O. & Säteri, J. (red.). FINVAC ry 10 s.

## PART 1: Facilities for outdoor testing of building components

Larsen, O. K., Heiselberg, P., Felsmann, C., Poirazis, H., Strachan, P. & Wijsman, A. 2009. An Empirical Validation of Building Simulation Software for Modelling of Double-Skin Facade (DSF). Building Simulation 2009 : University of Strathclyde, Glasgow, 27th-30th July: Proceedings of the 11th International Building Performance Simulation Association Conference. Strachan, P. A., Kelly, N. J. & Kummert, M. (red.). Energy Systems Research Unit : University of Strathclyde 8 s.

Marszal, A. J., Thomas, S. J., Larsen, O. K. & Heiselberg, P. 2009. Empirical Validation of Simple Calculation Method for Assessment of Energy Performance in Double-Skin Façade Building. ROOMVENT 2009 : Proceedings of the 11th International ROOMVENT Conference. Kim, K., Yoon, D., Yeo, M. S., Moon, H. & Park, C. (red.). s. 1173-1180. 8 s.

IEA EBC Annex 58 Subtask 1  
Inventory of full scale test facilities for evaluation of building energy performances

# OUTDOOR TESTING SITE



## GENERAL DESCRIPTION

### Main objective of the test facility

The outdoor testing site in Holzkirchen is the largest site in the world to investigate building structures on a 1:1 scale. Building components and building materials as well as system components for heating, ventilation and energy systems are tested under real climatic and application conditions.

### Overall lay-out

On an area of about 30.000 m<sup>2</sup> 27 test-houses and 7 office and laboratory buildings are located which are partly used for outdoor tests, too. Additionally more than 700 small specimens made of different ETICS, roof tiles or with painted surfaces as well as complex shaped specimen made of sandstone like the “Asterixe” are exposed for weathering. Building structures, building components, building materials and system components are analyzed with regard to weathering protection and durability. In cooperation with industrial partners various building components are investigated to identify their

Institute/organisation:



Fraunhofer Institute  
for Building Physics

Contact person:

Theo Großkinsky  
Fraunhoferstraße 10  
83626 Valley  
tel: +498024643223  
e-mail:

[theo.grosskinsky@ibp.fraunhofer.de](mailto:theo.grosskinsky@ibp.fraunhofer.de)

Exact location:

Valley, Germany  
°N, °E  
47° 52', 11° 44'



functionality and to develop suggestions for improvement. Wall systems, roofs, basements as well as floor plates can be tested. With a special examination hall it is possible to investigate wall sections, too. Two specific test facilities are described more in detail below: the half-timbered building and the adaptable roof test facility.

### Inside boundary conditions

The course of inside air temperatures and humidities can be controlled for most of the test houses depending on the aim of the investigations.

### Outside boundary conditions

Climatic conditions of Holzkirchen, located near the Alps. Cold winters and high radiation in summer as well as a high amount of driving rain- the prevailing extreme climate is especially suitable for this kind of testing. Since 1950 an own weather station is measuring and recording the climatic data on the test site. These data are necessary for the interpretation of the test results and are used as datasets for hygrothermal calculations.



## HALF-TIMBERED BUILDING

### Main objective of the test facility

The aim of the test facility is to investigate hygrothermal problems with half-timbered buildings and the energetic improvement of these types of buildings.

### Overall lay-out

The building has more than 80 rectangular elements with dimensions of 1m by 1m mostly built with spruce. The infills can be varied. At the moment some elements are filled with solid brick, lime silica brick, aerated concrete and in one case with mineral wool. The outer dimensions of the building are 9.9 m by 6.6 m. The eaves height is 3.35 m. The slope of the roof is 24°.

### Inside boundary conditions

The inside temperature is controlled by a floor heating system and the inside humidity by ultrasonic evaporators.

### Special limitations / possibilities

It is possible to change the infills, insulation systems and indoor climatic conditions. Because of the rectangular elements the air tightness can be measured with special equipment.

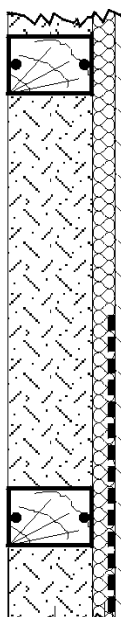

Wall section with inside insulation

## ADAPTABLE ROOF FACILITY

### Main objective of the test facility

This innovative test facility provides the unique option of investigating the hygrothermal performance of an attic construction with varied roof inclinations by gradually modifying the roof slope in steps. For the first time it is possible to examine angle-dependent effects without changing the roof construction. This is quite an interesting option, particularly when examining issues concerning the impact of defects/ blemishes due to settlement of insulating material or the effect of thermally induced convection in attic voids. It is possible to install several roof constructions side by side, in north and south orientations. This enables to compare directly different roof variations under the same boundary conditions. Replacing the various building components takes only a very short set-up time. It is no longer necessary to establish completely new roof constructions or even raise an entire new building just to perform tests of the attic construction.



### Overall lay-out

Situated below the actual roof test surfaces, there are four separate test rooms. Special care was taken in finishing the adiabatic construction of the enclosing surfaces. This was achieved by two measures, namely by applying high-quality thermal insulation to the external surfaces and by placing a controllable panel heating device in the curvature of the test room. These heating surfaces and the warm-air heating ensure a (largely) homogeneous temperature distribution in the chambers. The panel heating is used to establish the base temperature; the warm-air heating is used to compensate short-term temperature fluctuations. The ventilation device can be alternatively operated with recirculated air or with fresh supply air. The outdoor air change rate may be adjusted between a range from 0 to 5. The air in the test room is distributed through so-called 'Piccolo Ducts'. These ducts allow the air to flow into the room in a particularly uniform manner, spread across the entire width of the test room.



### Inside boundary conditions

Each test room can be individually heated, humidified, and ventilated in a different way. Ultrasonic humidifiers are used, which were selected for this purpose on account of their low energy consumption. In this way it is possible to establish an individual humidity profile in each chamber, which may be adapted to different, typical usage scenarios.

### Special limitations / possibilities

The test facility enables researchers to examine the attic components with regard to heat flows, air tightness, moisture behaviour and surface





temperatures. To perform measurements of heat flow, temperature and moisture in building components under outdoor climatic boundary conditions, sophisticated measurement technology and equipment have been provided. The test facility has been equipped with a data logging system that stores the measured data in a data base, providing data for evaluation and analyses. Real-time visualization of current data (on-line) and remote access (if requested by the client) are both possible.

## DATA ANALYSIS

### Typical equipment within test wall

Temperature sensors (pt100); RH-Sensors (capacitive); wood moisture sensors (resistance measurement), air flow sensors, heat flux sensors etc. are used, all of them from different manufacturers. The place, number and positions of the sensors are strongly dependent on the aim of the investigations.

### Accuracy and logging resolution

The temperature sensors have an accuracy of 0.1 K; the RH-Sensors of about 1 to 2 % r.H.; the accuracy of the heat flux sensors is about 5 % and the one of the wood moisture sensors is depending on the moisture range. The logging resolution varies from seconds to 1 hour or in case of wood moisture 1 day, dependant on the aim of the investigations.

## EXAMPLES OF PREVIOUS STUDIES

- Evaluation of energetic performance
- Evaluation of hygric performance
- Durability of plaster and renderings
- Microbial growth on facades
- Indoor climate
- Investigations on thermal comfort
- Interior insulation with different material
- Airing systems and airtightness
- Cultural heritage
- Influence of the infills on the moisture in wooden beams
- Smart vapour retarder
- Capillary active insulation





## MAINTENANCE / COLLABORATION

### Personnel involved

The maintenance of the test site and the investigations are conducted by a staff of several employees of two different departments within the IBP, deployed depending on the aims of the investigations.

### International collaboration

Different collaborations mostly within IEA and EU-programs

## RELEVANT LITERATURE

Künzel, H.M., Krus, M.: Beurteilung des Feuchteverhaltens von Natursteinfassaden durch Kombination von rechnerischen und experimentellen Untersuchungsmethoden. Internationale Zeitschrift für Baustandsetzen 1 (1995), H. 1, S. 5-19.

Krus, M.; Sedlbauer, K.; Zillig, W.; Künzel, H. M.: A New Model for Mold Prediction and its Application on a Test Roof. Tagungsband zum II. International Scientific Conference on the Current Problems of Building Physics in Rural Buildings, 9. - 10. Nov. 2001, Krakau, S. 26 - 46.

Sedlbauer, K.; Krus, M.: Experimentelle und rechnerische Untersuchungen an Holzfachwerk mit nachträglicher Innendämmung. Bauphysik 25 (2003), H. 3, S. 137 - 145.

Krus, M.; Sedlbauer, K.; Sinnesbichler, H.: Artificial thermal bridge with a dew point switch to accomplish an appropriate control of the ventilation for the prevention of mould growth in buildings. Intelligent Buildings in the Middle East 2005, Exhibition, December 5-7 2005, Bahrain.

Krus, M.; Fitz, C.; Holm, A.: Prevention of Algae and mould growth on facades by coatings with lowered long-wave emission. Research in Building Physics and Building Engineering. Editors Fazio, P.; Ge, H.; Rao, J.; Desmarais, G. Proceedings of the Third International Building Conference, Concordia University, Montreal, Canada, 27.-31. August 2006. S. 973 - 978. ISBN 0-415-41675-2.

Hofbauer, W.; Fitz, C.; Krus, M.; Sedlbauer, K.; Breuer, K.: Prognoseverfahren zum biologischen Befall durch Algen, Pilze und Flechten an Bauteiloberflächen auf Basis bauphysikalischer und mikrobieller Untersuchungen. Hrsg.: Fraunhofer-Institut für Bauphysik -IBP-, Holzkirchen; Bauforschung für die Praxis Band 77 (2006). IRB-Verlag. ISBN 978-3-8167-7102-9.



K. Breuer, C. Fitz, W. Hofbauer, M. Krus, R. Schwerd, N. Krueger:  
Wirksamkeit und Dauerhaftigkeit der Filmkonservierung von  
Fassadenbeschichtungen. Tagungsunterlagen TAE-Esslingen.

K. Lengsfeld, A. Holm and M. Krus: Moisture Buffering Effect - Experimental  
Investigations and Validation. Proceedings I of the Sixth International  
Conference on Indoor Air Quality, Ventilation & Energy Conservation in  
Buildings (IAQCEC 2007).

Sedlbauer, K.; Krus, M.; Künzel, H.M.: Innendämmungen im Fachwerk -  
Probleme und Lösungen (Teil 1). BAUTENSCHUTZ BAUSANIERUNG 7 (2002), S.  
44 - 47.

Sedlbauer, K.; M. Krus, M.: Bauphysik im Fachwerk - Alte Weisheiten und  
neue Erkenntnisse. Erscheint demnächst in Bauphysik.

Sedlbauer, K., Krus, M. und Künzel, H.M.: Die richtige Wahl - Materialien und  
Konstruktionen zur Innendämmung bei Fachwerken. Bautenschutz +  
Bausanierung (2002), H. 7, S. 44-48 und (2003) H. 1, S. 50-53.

Sedlbauer, K.; Krus, M.: Möglichkeiten der Innendämmung beim  
Fachwerkbau. Tagungsreader zur Fachtagung Innendämmung -eine  
bauphysikalische Herausforderung. Kooperationsveranstaltung  
Handwerkskammer Bildungszentrum / Kompetenzzentrum Bau und Energie  
und Fraunhofer-Institut für Bauphysik (IBP). Münster, 21. April 2005.

M. Krus, C. Fitz: Sichtfachwerk mit innenliegender Dämmung. - Neuartiges  
Messverfahren zur Ermittlung der Fugendichtheit und rechnerische  
Beurteilung des Konvektionseinflusses -. Internationales Journal für  
Technologie und Praxis der Bauwerkserhaltung und Denkmalpflege. WTA-  
Journal 3/06, S. 429-452.

M. Krus, C. Fitz Fachwerk mit Kerndämmung -Fugendichtheit und  
rechnerische Beurteilung des Konvektionseinflusses. Denk mal richtig -  
Denkmalschutz, Denkmalpflege Symposium 342.9. - 10. Mai 2007.

Krus, M.; Fitz, C.: Sichtfachwerk mit innen liegender Dämmung - Neuartiges  
Messverfahren zur Ermittlung der Fugendichtheit und rechnerische  
Beurteilung des Konvektionseinflusses. In: Historische Holzbauwerke und  
Fachwerk. Herausgeber Ansorge, G.;Geburtig, G. Fraunhofer IRB-Verlag,  
Stuttgart, ISBN 978-3-8167-7756-4, S. 129-148.

Sedlbauer, K.; Krus, M.: Feuchteadaptive Dampfbremse und kapillaraktiver  
Dämmstoff im Fachwerk - Welche Vorteile bringen sie? In: Ansorge, Dieter  
(Hrsg) u. a.: Historische Holzbauwerke und Fachwerk: Instandsetzen -  
Erhalten. Stuttgart: Fraunhofer-IRB-verlag (2008), H. 11, S8-9

Krus, M.; Sedlbauer, K.; Fitz, C.: Neue Lösungen zur energetischen Sanierung  
von Fachwerkhäusern. In: Venzmer: Eropäischer Sanierungskalender  
2009,Beuth-Verlag, ISBN 978-3410-16871-3, S. 7-25.

and numerous more

# CALORIMETRIC TEST FACILITY FOR FAÇADES AND ROOFS - IBP HOLZKIRCHEN



## GENERAL DESCRIPTION

### Main objective of the test facility

With the calorimetric facades and rooftops testing facility at the free field test area at Holzkirchen (Germany) the Fraunhofer Institute for Building Physics (IBP) is crossing borders concerning the testing of transparent building elements. It's a question of a completely new developed in-situ-test facility, which calls for own test procedures in order to deliver very reliable specific values for transparent building elements. Its main duty is the determination of Solar Heat Gain Coefficients (SHGC) and heat transfer coefficients (U-value). Similar facilities are either smaller in dimension, only capable of handling downscaled models, they have to forego without real weather or they are not able to track the sun.

Institute/organisation:



Fraunhofer Institute for Building  
Physics  
Branch Holzkirchen  
Departement Energy Systems,  
Germany

Contact person:

Dipl.-Ing. Herbert Sinnesbichler  
Fraunhoferstr. 10  
D-83626 Valley  
tel: +49 8024/643-241  
e-mail: herbert.sinnesbichler@  
ibp.fraunhofer.de

Exact location:

Holzkirchen, Germany  
47.874°N, 11.729°E



The calorimetric facades and rooftops testing facility under rotation.

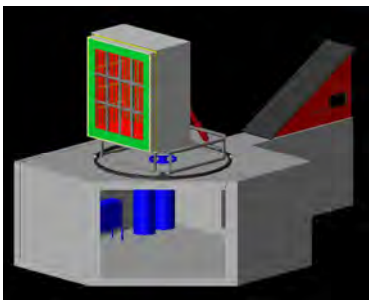

Schematic concept of the calorimetric facades and rooftops testing facility.

## Overall lay-out

The IBP's test facility for facades and roofs at Holzkirchen is basically a very big in-situ calorimeter. The opening of the measurement-box is capable to incorporate specimens up to a size of 3.5 x 3.8 m<sup>2</sup>. The measurement-box can be turned by 360° and slanted by 90°, thus the specimen can be engaged in any slope between horizontal and vertical. Featuring this kind of flexibility the measurement-box can either be moved heliostatic to provide normal radiation on the specimen all the time, it can track the sun with a fixed angle derivation or it can stay in a fixed position to emulate a real facade. Thereby it is also possible to determine the specific values (e.g. SHGC) for different solar incident angles (solar altitude and azimuth) or to investigate the dependence on any other boundary condition available through local weather.

## Inside boundary conditions

The five internal surfaces of the measurement-box are covered by high-absorbing water-bearing absorbers. The technical equipment in the basement keeps these components at a constant temperature while they are absorbing all radiation energy penetrating the specimen. The removed energy quantities necessary to keep the temperature in the absorbers is measured by high precision sensors. To get rid of any energy flow except the relevant one through the specimen it is mandatory to neglect i.e. minimize every energetic interaction between the measurement-absorbers and the walls outside surfaces. To achieve this, a further set of absorbers is located between the measurement-absorbers at the inside surfaces and the outside surfaces in the middle of a thick insulation layer. The temperatures of these water-bearing absorbers are controlled in such a manner, that the energy flow between the two absorbers is reduced close to zero. Absorbed solar radiation warms up the specimen. Due to convection this heat from the specimen is partly transferred to the air inside the measurement box. To keep not only the inside surfaces but also the inside-air at a constant temperature, this warm air is transported to a water/air heat exchanger by a powerful cross-flow-ventilator. The energy withdrawn from the inside-air is also recorded. The ratio between the radiative and the convective energy input can be used to derive an approximate ratio between the direct energy transmission and the secondary heat flux.

## Outside boundary conditions

The available solar radiation on the outside surface of the specimen is recorded by a pyranometer with a measurement-hemisphere identical to the hemisphere the specimen is facing. Knowing all energy flows to the inside of the measurement-box and the available radiation on the outside it is possible to calculate the Solar Heat Gain Coefficient (SHGC).

Climatic data recording is carried out by the central weather station at IBP Holzkirchen. This records the most important meteorological boundary conditions such as beam and diffuse global radiation, external air

temperature, relative humidity, wind speed and direction and air pressure. Furthermore beam radiation in the east, south, west and north directions are measured.

### Special limitations / possibilities

The components described above allow to perform a precise calorimetric measurement of all energy in- and outputs through the specimen e.g. of the SHGC and the Shading Coefficient (SC). They do not allow a detailed measurement of local temperatures, air velocities, thermal transfer resistance and glare indicators like the luminance from the specimen or the DGP. To be able to perform these kinds of measurements the calorimetric facades and rooftops testing facility of the IBP is equipped with a three-dimensional robot carrying a sensor-mounting-platform able to reach any position within the measurement-box (see schematic drawing on the right side). The equipment of this mounting-platform could be an air-temperature-sensor, an air-velocity-sensor, a contact-free rangefinder, a pyranometer, a lumination-sensor or a high resolution luminance photometer. The rangefinder can e.g. be used to determine deformations on specimens like foil-constructions. The lumination-sensor and the pyranometer together with their counterparts on the outside of the specimen allow calculating integral solar and visible transmissions through transparent and translucent specimens. The luminance photometer can be used to determine weak spots in the glare-protection properties of the specimens and calculate glare indicators like the DGP (Daylight Glare Probability). The modular construction of the mounting-platform allows an easy addition of further sensors.

## DATA ANALYSIS

### Typical procedure for analysing a specimen

#### Measuring the Solar Heat Gain Coefficient

The measurement-box will track the sun and the inside air and inside surfaces will be kept at exactly the same temperature as the ambient air to avoid any heat transmission losses to the outside. From the amount of energy necessary to keep the temperature inside the measurement-box constant and the amount of solar energy available on the outside, the ratio of energy penetrating through the specimen can be calculated.

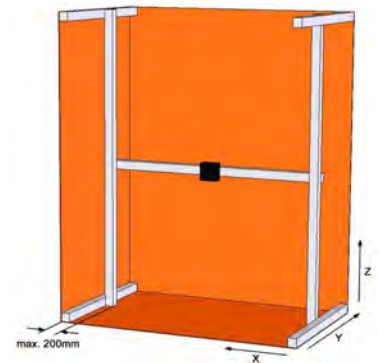

Schematic concept of the three dimensional robot of the calorimetric facades and rooftops testing facility.

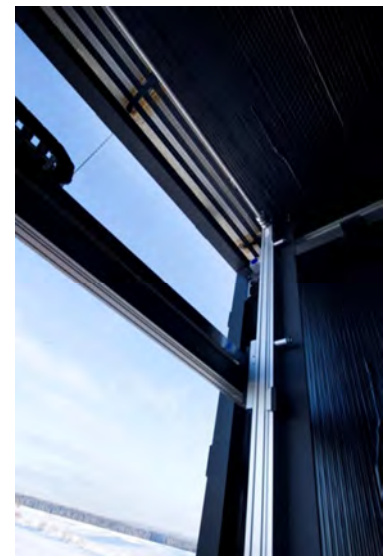

Robot of the calorimetric facades and rooftops testing facility.

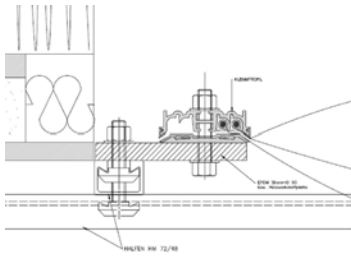

Schematic mounting-concept of a foil-pillow into the specimen-incorporation of the calorimetric facades and rooftops testing facility.



The calorimetric facades and rooftops testing facility during the mounting of a specimen.

The SHGC is defined for direct radiation only. Exclusively direct radiation does not occur under real conditions. Real conditions provide only diffuse radiation on overcast days and a mixed global radiation on clear days. The SHGC will be measured for global and for diffuse radiation. From these two values the SHGC for direct radiation can be derived.

Typical equipment:

- pyranometer at the outside surface
- flow meters to measure all energy flows to the inside of the measurement-box

### Measuring the heat transfer coefficient

The heat transfer coefficient is measured at night when no solar radiation is creating gains within the measurement box. The specimen is tilted into a specific slope, which is defined together with the contractor. This slope should represent the slope the element will be installed later. The inside air and inside surfaces of the measurement-box are kept constantly 20 K above the ambient temperature, so that a constant heat flow to the outside through the specimen is created. If this heat flow is divided by the temperature-difference of 20 K and by the specimen-area the heat transfer coefficient can be obtained.

Typical equipment:

- heating devices to create a certain temperature level in the measurement box
- flow meter to measure the energy which is necessary to keep a constant temperature difference between the measurement box and the outside conditions

### Measuring the integral transmissions

To measure the integral visual and solar transmission through the specimen two photometers and two pyranometers are used. One of each installed on the outside and one of each mounted on the movable robot-head behind the specimen. The measurement-box tracks the sun completely by two axis to keep the direct part of the solar radiation at a normal incidence angle all the time. The internal sensors on the movable head will record the amount of the radiation behind the specimen in a grid of 0.1 m. For every point transmission values will be calculated. This procedure is necessary to calculate a mean value for the complete specimen because the ratio of transmission will vary from the centre to welding.

### Analysis of the data

The first step of data analysis is done by a software system developed at IBP and optimised for the requirements of structural physics research, called Ime-

das<sup>TM</sup>. It is a server-supported system which bundles all project information and makes it available to those participating in the measurement project via corresponding function modules. Editing takes place using a normal web browser. Imedas<sup>TM</sup> consists of the following individual modules:

- planning tools (test bench configuration)
- measurement and communication program
- visualisation with and without integrated HMI (Human-Machine Interface) functions
- central database for measurement and condition values
- documentation and information system
- user and project management

With the help of Imedas<sup>TM</sup> it is possible to create graphs automatically which is useful for first interpretations and data control. The real analysis of the data is then done by other software tools (e. g. MS-Excel, Origin etc.). The kind of analysis depends strongly on the investigations and cannot be described blanket. In line with the trial run of the test facility an important task is the development of rules and standards for the measurement procedures and data analysis.

## MAINTENANCE / COLLABORATION

### Personnel involved

The CALORIMETRIC TEST FACILITY FOR FAÇADES AND ROOFS is run by the group façade concepts (Group leader: Herbert Sinnesbichler) in the department energy systems of the IBP.

## RELEVANT LITERATURE

### Literature on previous measuring campaigns:

As the first measurements at the test facility start in 2012 there is no literature on previous measuring campaigns available.





## LWF-FAÇADE-FACILITY



**Institute/organisation:**

Hochschule **Rosenheim**  
University of Applied Sciences



Department of Research and  
Development

## GENERAL DESCRIPTION

### Main objective of the test facility

In 2011, a unique façade test facility was put into service by the Josef Gartner GmbH on the campus of the University of Applied Sciences Rosenheim. It allows comparative in situ studies of photometric issues and building physics, in particular studies on comfort and total energy performance of façade elements.

The LWF façade test facility allows exact and comparable tests of the effects of design features of vertical and tilted façade systems under realistic weather conditions. It is possible to examine and verify theoretical models of heat flow and solar radiation of up to three different façade elements. Energy efficiency can be evaluated with the parameters of heating, cooling and artificial light. The performance of the test facility has been confirmed by the

**Contact person:**

Prof. Dr. Franz Feldmeier  
Building Physics  
Hochschulstraße 1  
83024 Rosenheim  
GERMANY  
+49(0)8031 805440  
feldmeier@fh-rosenheim.de

**Exact location:**

Rosenheim, Germany  
47,866°N, 12,109°E



Location of the test facility on the campus of the University of Rosenheim.



Overview on the site of the test facility.

characterization of different CCF-Systems (Closed Cavity Façade) of the Josef Gartner GmbH.

Nowadays the architecture of office buildings is created mostly with expansive transparent glass panels, which enable high solar heat yields. Likewise technical equipment such as office devices and artificial lighting are additional internal heat sources. Next to energy efficient heating in the winter the protection from summer heat and the thermal comfort at the workspace is important. Shading to avoid overheating is a major aim of the façade. It should provide the room with as much daylight as possible without causing any glare at the computer workspace. These diverse and at times contradictory demands make a thorough determination of the parameters necessary.

### Overall layout

The site of the test facility with a total area of 1000 m<sup>2</sup> is located at the southern end of the campus of the University of Rosenheim. The location is largely unspoilt, although a university building is located in the northern area.

The facility is positioned 2m above the ground. Vertical and horizontal axes allow different orientations and any solar angle on the façade which can be maintained by heliostatic tracking for several hours. The overall size of the cuboid is approx. 13m in length 5.5m in width and 6m of height. Exterior walls and the floors are insulated with 10cm PUR foam panels, the ceiling with 12 cm panels.

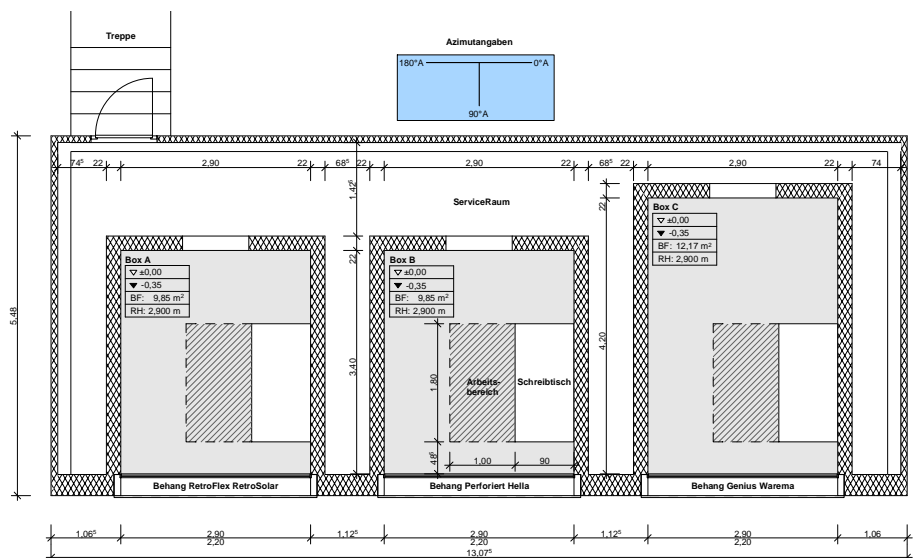

### Floor plan of the test boxes

Three insulated (PUR foam) test boxes, surrounded by an air-conditioned service room are situated inside the facility. The façade front of the test boxes is the only wall exposed to the outdoor climate; test elements (2.20 m high and 2.90m wide) can be fixed here. Room A and room B are identical in

## PART 1: Facilities for outdoor testing of building components

structure (28.6 m<sup>3</sup>), room C (35.3 m<sup>3</sup>) allows for the study of the impact of the depth of a room on thermal and lighting behavior. Double skin elements with different hangings in the intermediate space of the façade were tested.

### Inside boundary conditions

The suspended ceiling of the test boxes can either be used for heating or cooling. Control units operate conditioning, artificial light and hangings using a LON bus system. A multi-sensor positioned in the suspended ceiling coordinates artificial lighting. It measures the brightness and can take the presence of people into account. The height and angle of the slats of the hangings can be adjusted. The building automation not only uses the time of day (for calculating the solar altitude) but also data from the weather station on the façade. The thermal room conditioning is set by a scheduler, which simulates the presence of people.

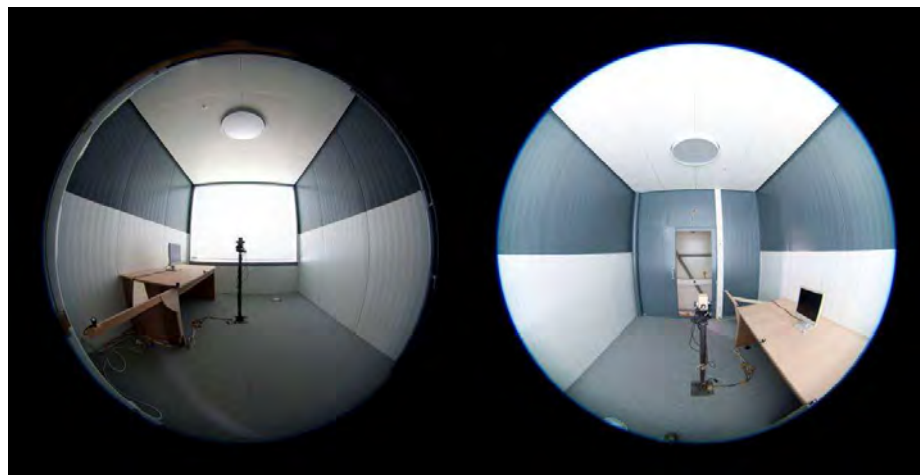

Picture taken with a fish-eye lens of test box A, view of the façade (left) and the backside of the room (right).

The selection of the colours of the spatial surfaces is chosen to fit modern office accommodations. Each test box is equipped with an office desk and a monitor.

### Outside boundary conditions

Rosenheim is located in the Bavarian Alpine foreland in south-eastern Germany. The area as a whole has a temperate climate with an annual average temperature of approx. 9°C and an annual precipitation of around 1200mm. The outside conditions of the test facility are measured by a weather station located on the rooftop of a university building approx. 100m away. Outdoor temperature (additional independent temperature sensors are positioned at the test facility), humidity, air pressure, wind speed and global radiation are recorded.

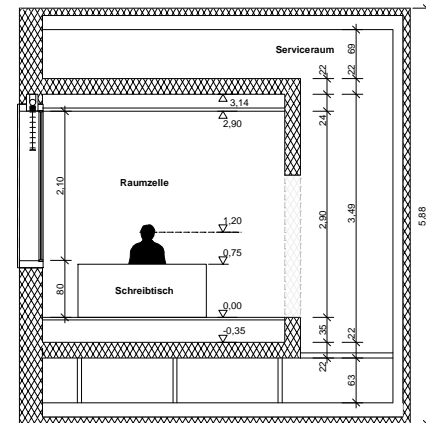

Cross-section of a test box and the service room.

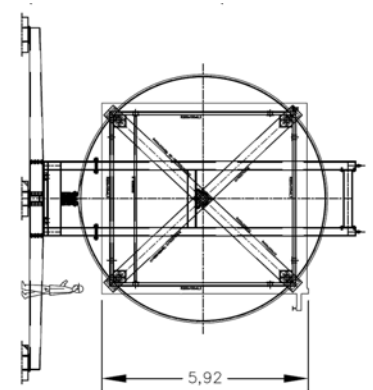

Construction / View from the west  
BBRI



Radiation pyranometer with a circle to cast a shadow over the sensor in order to measure diffuse solar radiation.

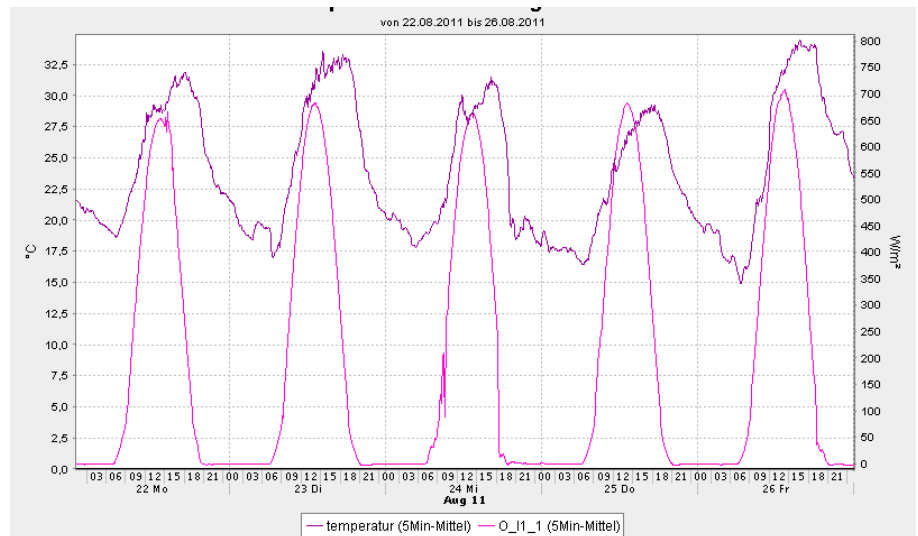

Outside temperature (violet) and radiation vertical to the façade (5 days)



Sensors for air temperature, radiation and air speed are set up in the middle of the test room.



Test room with sensors, view outside the façade element.

## DATA ANALYSIS

### Typical equipment within the test wall and test box

Depending on the conceptual formulation, more than 270 sensors can be installed and read out. These can be categorized into sensors for measuring comfort, thermal properties and lighting. The data is recorded by a modular data logger or LON bus and centrally stored in a data base. Generally the data is captured every 5 minutes. The preparation and evaluation is carried out with the programming system MoniSoft (developed by the University of Karlsruhe).

To determine all impacts on the indoor climate, parameters of the outside climate, among others radiation, as well as direct and diffuse irradiation on the horizontal surface are recorded. Additionally the radiation outside the façade and inside the test rooms were measured to compare differently shaped rolling shutter slats.

## PART 1: Facilities for outdoor testing of building components



*Different hangings used for comparative studies.*

Inside the test rooms are sensors for measuring surface temperatures, air temperatures, radiation temperature, humidity and air velocity. The sensors were installed according to DIN EN ISO 7726 at different heights near the workspace. The angle of the slats of the venetian blinds and the heat load of the climate ceiling is recorded. A heater of 210 W (EN 14240) simulates the heat dissipation of people and electrical devices.

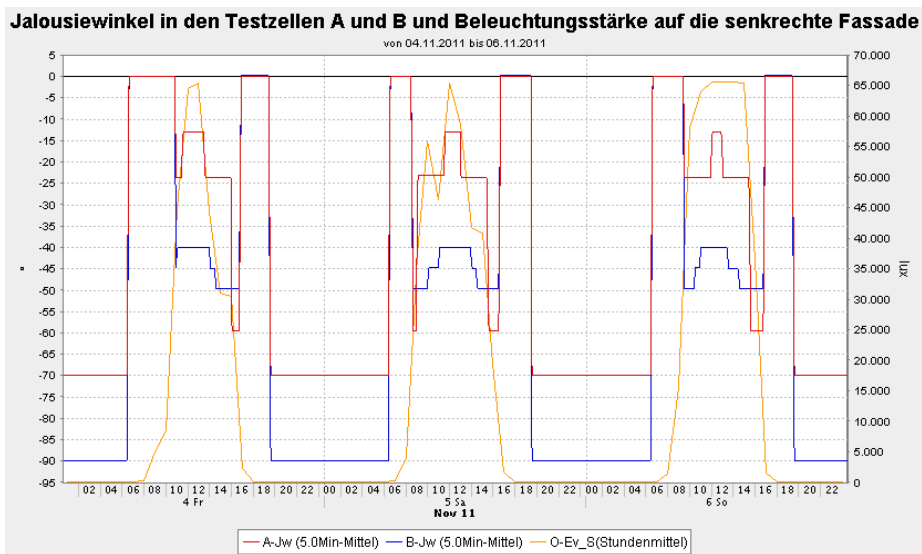

*Angle of slats of venetian blinds Façade A (red), façade B (blue); illuminance level vertical to façade (yellow); During the night hangings are closed (A:70°, B:90°), in the morning and in the evening both blinds are fully opened (0°); Depending on irradiation the hangings close differently.*

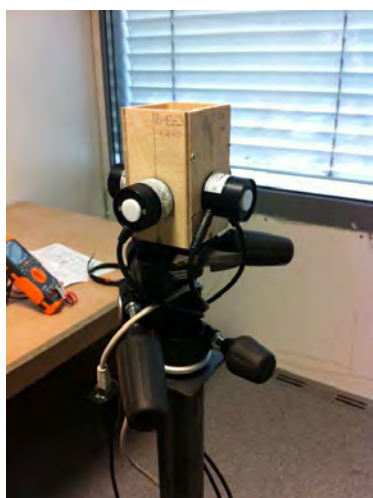

Illuminance sensors



Canon Eos D450 for luminance measurements with separate illuminance sensors

## Accuracy and logging resolution

Specification and accuracy of sensors and measuring instruments:

Instrument	Manufacturer	Model	Measurement Range	Accuracy
Data loggers	Agilent			
Thermo-couple	NEWPORT Electronics, Inc TC Direkt	Type K and J PT 100	-200°C - 1370°C -30°C - 70°C	± 0.1K ± 0.15K
Ball thermo-couple	Design HsRO (DIN EN ISO 7726)			
Anemometer	Schildknecht	Thermo Air64	0.01m/s - 1.0m/s	± 1.0%
Relative humidity sensor	Sensirion	SHT75 FE 09/1		± 1.8% ± 0.3°C ± 2%
Power measurement, heating/cooling of ceiling	Sontex SA	Superstatic 440 Supercal 531 PT500	qp 1.0m <sup>3</sup> /h 4l/h	± 5%
Power Measurement, ceiling light	Gossen Metrawatt	U1381		± 1%
Illuminating sensor	Ahlborn	FL A623 VL Ombra W2		≤ 10%
Luminosity sensor	Spega (outside on façade) Spega	Lumina MS3-EB		≤ 2% ± LUX (+10°C - +30°C) (10-1000 LUX)
Glare sensor	TechnoTeam CMOS Canon ASP-C	Eos D450	0,3 cd/qm - 100.000 cd/qm 1728(H) x 1152(V)	
Radiation pyranometer	Kipp&Zonen	CMP 11	0-2000W/m <sup>2</sup>	≥ 10 W/m <sup>2</sup>

## Analysis of the data

The test facility has mainly been used to study lighting control, supply of daylight, glare and comfort. The determination of thermal properties - the U-value - was carried out with the steady state procedure.

### Thermal comfort:

An integral assessment of the indoor climate is carried out by the means of DIN EN ISO 7730 by using the parameters PMV (predicted mean vote) and PPD (predicted percentage of dissatisfied). The parameters take into account the nature of the work performed (metabolic rate) and the clothing (insulation value). Additionally local comfort criteria are measured. A direct comparison of up to three hangings or façade systems can be carried out.

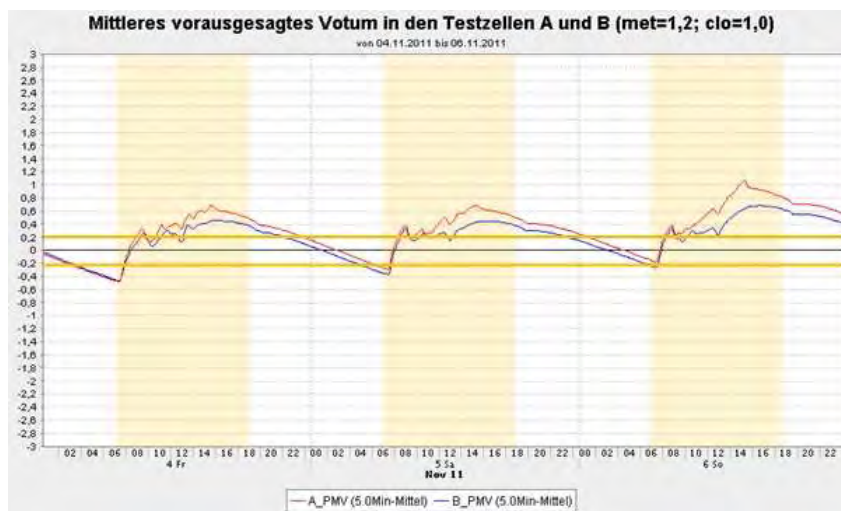

Predicted mean vote (PMV); test room A (red), test room B (blue); limit value for the category A (yellow); time of residence (yellow background)

### Glare analysis:

Visual comfort can be evaluated by considering different influences. Of particular importance is the glare-free working environment. To judge the quality of illumination the room is checked for the level of luminance, which measures the impression of brightness the eye gets. A false colour display returns absolute figures to estimate possible glare. The level is measured by high quality calibrated luminance cameras. To consider all possible lighting situations in very short time the rotatability and the tilt ability of the cuboid is used.

All measured lighting situations are analysed by a method that processes the luminance level and generates a condensed numeric statement to each picture using the Daylight Glare Probability-Index (DGP), which represents the “percent of people disturbed”.

Carpetplot - Blendungswahrscheinlichkeiten  
 in Abhängigkeit des relativen Sonnenwinkels auf die Fassade  
 Sonnenschutzlamellen jeweils im Cut-Off Winkel lauder 90° max. zul

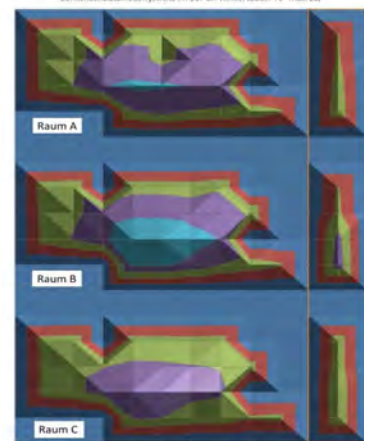

Carpetplot - Daylight Glare Probability (DGP) depending on the elevation and relative azimuth. Closed venetian blinds and 90° solar angle to façade.

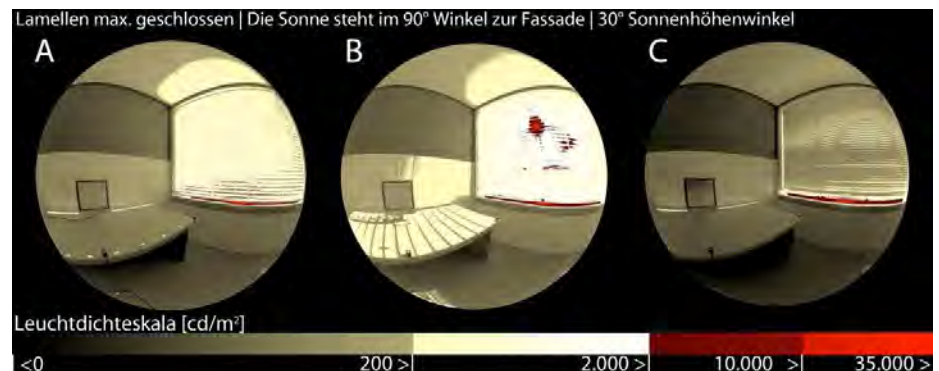

*Luminance level of the three test rooms; venetian blinds closed; 90° solar angle to façade; 30° solar height*

#### Heat transfer coefficient (U-value):

Measuring methods are performed in accordance with the policy of DIN EN ISO 8990:1996 as well as with the arrangement of measuring points DIN EN ISO 12567-1. The temperature regulated test box can be considered as a “regulated heatbox” after ISO 8990. In order to determine the heat transfer coefficient with this method using data in steady state, the boundary conditions should be as constant as possible. In the city of Rosenheim especially, cloudy autumn days are suitable: temperatures remain close to the freezing point and radiation is low.

A method using dynamic measurement results has not yet given results with the required accuracy, but is the subject of current research.

#### Solar energy (g-value):

The overall solar energy transmittance is determined using calorimetric measurements. So far, no in situ measurements have been used to determine the g-value. This is also the subject of current research.

## EXAMPLES FROM PREVIOUS STUDIES

The test facility has been used to rate CCF-façade systems of the Josef Gartner GmbH. In this study thermal and lighting conditions, as well as the comparison of different blinds regarding thermal comfort, sun efficiency, protection systems, incidence of daylight and glare were of interest. Another part of the analysis dealt with the energy consumption for heating, cooling and artificial light, which enables the efficiency of facades from administration buildings in its entirety to be assessed.



These studies have impacted the design of complex aluminium-glass facades, in particular their construction and the selection of materials as well as the regulation and control algorithms of shading systems and air-conditioning methods.

## MAINTENANCE

### Personnel involved

The test facility is maintained by the technical staff of the Building Physics Section and the Department of Research and Development of the University of Rosenheim. The data analysis is also performed by these departments.

### Link to other devices

The laboratory of the building physics section of the University of Rosenheim is equipped with different devices for thermal measurements and analysis.

- Multichannel recording
- Guarded hot box
- Guarded hot plate
- Heat flow meter
- Thermography
- Spectrometry  
UV-VIS-NIR  
FIR  
g-value  
IR Emissivity



Guarded hot box

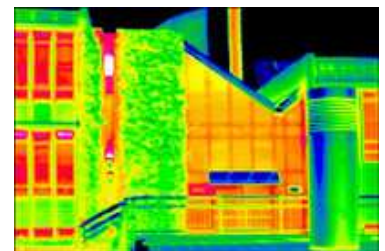

Thermography



Spectrometry

## LITERATURE

A.Hack, F. Feldmeier, M.Wambsganß, J.Zauner: Neue Versuchsanlage in Rosenheim - Vergleichende in-situ Untersuchungen zur thermischen Behaglichkeit. Ernst & Sohn Spezial 2012 - Innovative Fassadentechnik, 2012.

J.Zauner, F. Feldmeier, A.Hack, M.Wambsganß: Neue Versuchsanlage in Rosenheim - Vergleichende in-situ Untersuchung zur Kunst- und Tageslichtversorgung. Ernst & Sohn Spezial 2012 - Innovative Fassadentechnik, 2012.

Forschungsbericht 2012, Hochschule Rosenheim, inixmedia GmbH, Kiel, Juli 2013.

C. Schäfle, F. Feldmeier, C.Lux: Investigation of the total solar energy transmittance on building-integrated, semitransparent photovoltaic modules with and without extraction of electrical power. Bauphysik 34, Heft 4, p. 153-156, 2012

F. Feldmeier, T. Skora: High-Tech-Offensive Bayern, Holzbau der Zukunft TP 05: Leichte Vorhangfassaden aus Holz, 2008.

F. Feldmeier: Klimabelastung und Lastverteilung bei Isolierglas, Stahlbau 75 Heft 6, 2006.

F. Feldmeier, L. Wallersheim: Felduntersuchung zu den klimatischen Besonderheiten in Eissporthallen und zur Wirksamkeit von Maßnahmen zur Vermeidung von Tauwasserschäden, Holzabsatzfonds, 2007.

TUD COST Action TU0905 Structural Glass - Novel design methods and next generation products.

F. Feldmeier: Dreischeiben-Isolierglas, Beanspruchung des Isolierglasrandverbundes durch interne Lasten, Bundesverband Flachglas, 2011.

*(All pictures University of Applied Sciences Rosenheim)*

## TEST CELL IN FLORENCE



## GENERAL DESCRIPTION

### Main objective of the test facility

Evaluation of thermal-physical properties of new building components is usually carried out in stationary conditions. In South Mediterranean area, thermal variation is significant and the effect of thermal mass should be investigated and taken into account in new and retrofitted projects focusing on thermal comfort in relation of energy saving.

The test cell proposed by the Florence University, with the aim to become an outdoor laboratory able to test new vertical façade components that needs to be used in Mediterranean Climate. The paper synthetically describes the structure of the test Cell and data acquisition system used for monitoring activity of indoor and outdoor parameters.

### Institute/organisation:



UNIVERSITÀ  
DEGLI STUDI  
FIRENZE  
**DIDA**  
DIPARTIMENTO DI  
ARCHITETTURA

Università degli Studi di Firenze  
Dipartimento DIDA

### Contact person:

Giuseppina Alcamo and  
Alessandra Donato  
via San Niccolò 93,  
tel: +39.055.2755528  
e-mail: giuseppina.alcamo@unifi.it  
alessandra.donato@unifi.it

### Exact location:

via Santa Marta 3,  
Florence, Italy  
43° 46' N, 11° 15' E



The project of the test cell has been part of a largest project *Abitare Mediterraneo* financed by the Tuscany Region with the scientific contribution of several experts coming from the Florence University and with the collaboration of several regional building sector's companies.

The test-cell will be similar to PASSSYS test cell but in wooden structure with low thermal bridges, insulated frame, routable platform, accurate flux sensors, with the aim to measure and compare thermal differences of new opaque and transparent components - on dynamic external conditions - also different day-lit distribution due to orientation.

### Overall lay-out

The test cell structure consist of a wooden platform frame, with horizontal and vertical components made with same thickness, same material, same structure, same U-value ( $0.32 \text{ W/m}^2\text{K}$ ). It is able to test façade components into an insulated frame, with dimensions of 2.80 m x 2.80. m.

It is possible to change orientation thanks to a rotating base, connected to the ground with 30 screws Krinner type. Two carriages placed at the base of the structure allow rotation on a circular platform in order to conduct tests with different orientations. The interior of the Test Room will be coated with flux-tiles, tiles that will measure the heat flow through the walls from inside to outside.



View of the circular platform base, connected to the ground with screws Krinner type.

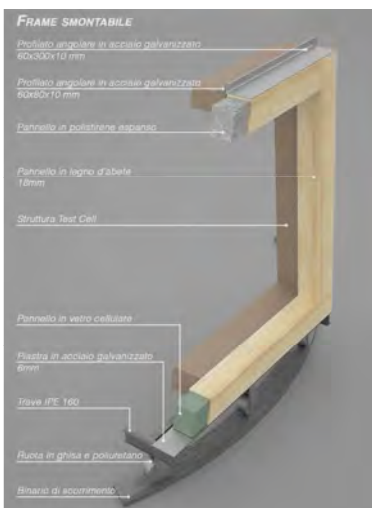

The insulated frame to test opaque and transparent façade components.

### Inside boundary conditions

The outdoor test cell is an instrument that is required by the Tuscany Region for giving the opportunity principally to local building market to test new building construction components able to reduce annual energy consumption in buildings working with a sufficient insulation level and appropriate thermal inertia if necessary.

Also, the test cell will be used to evaluate the influence of the orientation when using a transparent components and the correlation with window dimensions and forms in relationship to the daylight factor under clear sky conditions, normally sky during the year in most of the Mediterranean area.

In this way, the test cell has to measure the U and g value of components and also the thermal lag and the DLF. It will have inside a radiator for internal temperature control with a ventilator. They will be used during the winter to evaluate the flux from inside to outside.



View of the site before the installation of the test cell

## Outside boundary conditions

The test facility is located in outdoor under real weather conditions. To reduce the overheating inside the test cell, the envelope is covered by an external shading to reduce to zero the direct solar radiation on test cell components. The screening is realized in wood material at a distance of 20 cm from the test cell envelope to guarantee an adequate ventilation between the test cell and the shading devices.

## Special limitations / possibilities

The test cell it has been realized to test opaque and transparent vertical building components, ventilated facades, shading devices, and all other vertical building components such as PV systems, PCM materials etc.

It has been designed studying PASSLINK test cells and trying to resolve some limitations emerged in outdoor test cell built in the past, such as overheating, thermal bridge effect, problems due to infiltrations, not insulated frame.

It is not an adiabatic test cell, with a very low thermal bridges do to the wooden structure and due to the fact that all test cell's components -facades, floor and roof, are made with the same thickness, same materials, same U value. It is positioned on a routable system to evaluate differences in building components performance in different orientation and also to make measurements in terms of DLF.



*The test cell in wood with the external wooden solar screening.*

# DATA ANALYSIS

## Operating conditions

The Test Cell structure, as well as the stability of the instrumentation contained in the test room, requires to keep a defined range of internal temperatures. Extremely high temperatures can cause changes to the properties of adhesive materials contained in within the construction components and to the structure of the network connecting the sensors to the data acquisition unit ( DAS Data Acquisition System ).

Therefore, according to protocol PASSYS, the range of internal temperature into the Test Room and the Service Room could be set between 5 °C and 45 °C.

## Data acquisition system DAQ



View of the Data Acquisition Unit placed in the Service Room.

The Test Cell is equipped with indoor and outdoor instrumentations managed by a Data acquisition system, DAQ suggested by PASSYS protocol including:

- sensors, connected via hardware channels. These send signals to analog data acquisition unit ( Data Acquisition Unit ) ;
- an HP / Agilent 34980A Control Unit, which can be connected to 7 additional slots, provided with :

- HP 34921A ( 40 channels) Armature Multiplexer for measurements with thermocouples type T ;

- HP 34922A (70 channels) Armature Multiplexer for 2 or 4-wire sensors ;

The data acquisition system has been configured in Labview in order to allow the acquisition of data from more than 80 sensors with an interval of acquisition at the choice of variable between 30 -60 sec.

The external climate data ( pyranometer, barometer, cup anemometer, and windmill anemometer) are sent from the meteorological station of the Department of Industrial Engineering to a further existing data acquisition system and made available through a local network via wireless signal.

## Monitoring Instruments

Indoor parameters that will be measured in the Test Room are Ambient Temperature, Relative Humidity, Radiant Temperature, Surfaces Temperature, air speed and illuminance levels.

Outside a meteorological station will record outside temperature and RH, atmospheric pressure, wind velocity and direction, direct and diffuse horizontal solar radiation, global vertical solar radiation.

Sensors positions will be the same of PASLINK test cells.

The list below shows the devices that have been placed on the Test Cell for the measurement of the indoor and outdoor parameters and the technical specifications indicated in each datasheet.

### Outdoor climate data :

- Barometric transmitter with 4 ... 20mA output , working range 800 ... 1100mbar . supply 8 ... 35Vdc , working temperature range -30 ° C ... +60 ° C.
- First class pyranometer A13LP PYRA02AV (according to ISO 9060 ). Complete with shade , cartridge for crystals of silica gel , 2



The pyranometer device to measure the global vertical solar radiation on test wall.

## PART 1: Facilities for outdoor testing of building components

cartridges, spirit level for leveling and Report of Calibration. Signal output voltage , amplifier built-in transmitter . Power supply 10 ... 30V .

- Humidity and Temperature miniature Transmitter, RH range : 0 ... 100% , T range : -20 ... 80 ° C, polycarbonate enclosure , Output : 2 x 0 ... 1V, power : 4.5 - 15V DC version cable , 2 meters long , filter wire mesh .
- Cup anemometer Out: 4-20 mA or 0 ÷ 2Vdc Full Report of Inspection and windmill anemometer range 0 ÷ 359 ° Out: 0 ÷ 2Vdc with mounting pole and cab 5 mcomplete Report of Calibration.
- Photometric probe for measuring illuminance , outdoor use, according to CIE photopic filter, diffuser for cosine correction , protective dome K5 .. Amplified Output 0 to 10 Vdc . Power supply: 15 -30V .

### Indoor data :

- Thermocouples Copper / Constantan ( T ) obtained from TF/TF-24-TT cable with Teflon insulation L = mt.7 with free terminals and hot junction welded lug hole with a diameter of 4 mm .
- Resistance thermometer Pt 100 ohm at 0 ° C in Class 'A' - steel sheath diameter of 6 mm and L = 120 mm Enlarged diameter 25 mm for fixing in protection from solar radiation - mt.7 cable 4-wire PVC insulated .
- Probe thermo globe thermometer to measure radiant temperature diameter 150 mm ( ISO 7243 , ISO7726) with PT100 sensor range -30 to +120 ° C.
- Air velocity transmitter with hot-wire 0 ... 10Vdc output . Measuring range: 0.08 ... 5.00m / s.
- Photometric probe for measuring illuminance , outdoor use, according to CIE photopic filter , diffuser for cosine correction , protective dome K5 . You may replace the silica gel when exhausted. Amplified Output 0 to 10 Vdc . Power supply: 15 - 30VDC .

To measure the heat flow through the external walls of Test Cell, all the internal surfaces of the Test Room will be coated with heat flux tiles except for the test wall.

Although there are several types of heat flux sensors commercially available, the Department of Industrial Engineering has chosen to develop and build a new prototype of heat flux sensors based on the physical behaviour of the Peltier cells. Each tile (53x53 cm) is realized by the assembly of several layers of different material for a total thickness of 8.55 mm, each one using a Peltier cell of 40x40 mm and 4 mm of thickness as sensitive element.

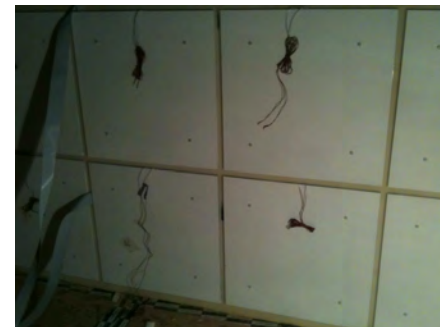

*Heat flux tiles covering the internal surface wall of the Test Room.*



*Calibration test of a heat flux tile.*

The output voltage measured by each tiles will be representative of the thermal flow through the wall according to a linear function. Part of the research has focused on the manufacture and assembly of 233 tiles and their calibration through laboratory tests.

### The Heating System

The heating system currently in use consists of a heating convector equipped with 8 fans and a thermostat to keep the internal temperatures within the range previously defined. Also this plant is controlled and monitored from the data acquisition system.

## MAINTENANCE / COLLABORATION

### Personnel involved

The test cell is going to be realized using a project developed for a PhD thesis at the University of Florence, Technological and Design Department. The project is part of *Abitare Mediterraneo*, project proposed by the University of Florence with the financial support of the Tuscany Region and in collaboration with several Tuscany industries. It is going to be enlarged to other industries interested in developing new products for Mediterranean Habits.

The responsible of the project is Marco Sala; the person responsible for adaptation and construction of the test cell is Giuseppina Alcamo; the responsible of the test facilities is Maurizio De Lucia, Energetic and Mechanical department of the University of Florence. The responsible for instrumentation is Alessandra Donato also responsible for data analysis.

### International collaboration

The test site should be active in the Dynastee Network to exchange experience and to collaborate at an international level.

The project of the test cell has been made with the supervision and support of Dott. Hans Bloem, JRC Ispra.

### Link to other devices

The test cell is part of a larger strategy of the *Abitare Mediterraneo* Project: new building components need to be certificated not just only from thermo-hygrometric point of view but also they have to be in line with acoustic requirements, fire resistance requirements and structural requirements.

The University of Florence is going to involve internal departments and also external laboratories to give to the companies the most strong and complete



support in developing new building components suitable for Mediterranean climate, simulating components with adequate dynamic software, analysing LCA and testing under real user conditions and laboratories to certificate new *Abitare Mediterraneo* products.

## RELEVANT LITERATURE

### General literature about the test facility:

G. Alcamo, M. De Lucia. *A NEW TEST CELL FOR THE EVALUATION OF THERMOPHYSICAL PERFORMANCE OF FACADES BUILDING COMPONENTS* in *International Journal of Sustainable Energy*, Taylor and Francis, 2013.

G. Alcamo. *Sistemi per valutare e comparare in opera le prestazioni energetiche di componenti edilizi: progetto di una test - cell per il Clima Mediterraneo*. PhD thesis will be discussed next April 2011.

G. Alcamo. *The overheating control in Mediterranean area: thermophysical evaluation of new facade components through a test cell*. Paper for OSDOTTA 2011, under publication.

More information about the *Abitare Mediterraneo* project are available at the following website: [www.abitaremediterraneo.eu](http://www.abitaremediterraneo.eu)



## ZEB TEST CELL



## GENERAL DESCRIPTION

### Main objective aim of the test facility

The ZEB Test Cell is currently under commissioning and will, according to plan, be erected during 2013. Studies on thermal and hygrothermal performance of façade and roof elements coupled with HVAC component and system performance are the mayor aims of the test cell.

The main test facility will be centred around two identical, adjacent test chambers on the south side of the test cell. The test chambers are built up as calorimetric cells where the internal climate can be precisely controlled. The façade elements of the test chambers are fully interchangeable.

### Institute/organisation:



### Contact person:

Steinar Grynning  
Høgskoleringen 7b  
N-7465 TRONDHEIM  
+47 975 66 103  
Steinar.grynning@sintef.no

### Exact location:

Trondheim, Norway  
63.41°N, 10.41°E

The roof will be partly modular (i.e. interchangeable) and instrumented. The aim is, amongst others, to study internal convection in highly insulated sloped roofs as well as solar thermal and building integrated PV performance.

### Overall lay-out

The test cell will be built as shown in the figure below.

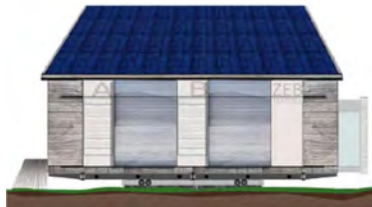

South façade, showing the two interchangeable façade elements of the calorimetric cells.



West façade.



East façade.



North façade.

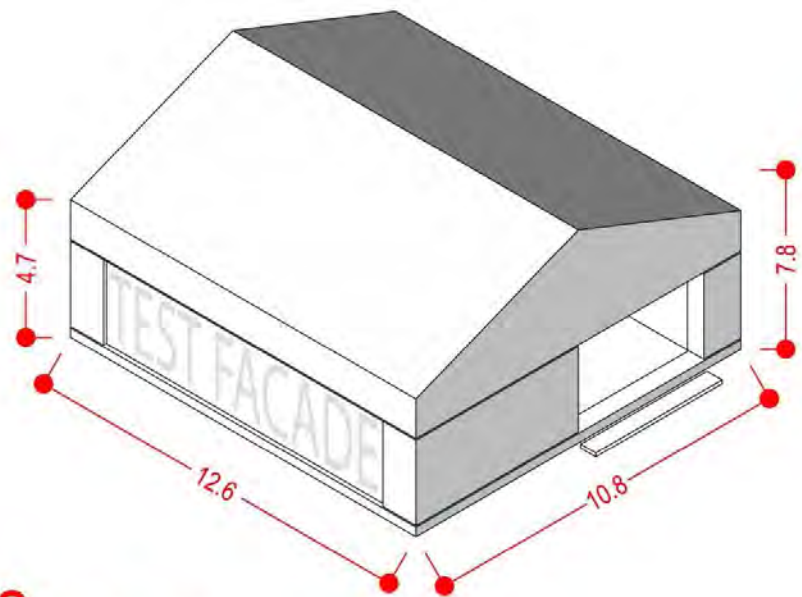

## 2 ZEB TEST CELL

footprint area: 136.1 m<sup>2</sup>

#### Test cell dimensions

Architectural footprint	(m <sup>2</sup> )	136,2
Gross volume	(m <sup>3</sup> )	879,6
External surface	(m <sup>2</sup> )	578,1
Heated surface (floor area)	(m <sup>2</sup> )	88.4

#### The envelope

Envelope part	Area (m <sup>2</sup> )	U-value (W/(m <sup>2</sup> K))	Construction
Walls	245,7	0,09	42 cm insulated wood frame
Floor	136,2	0,10	38 cm insulation
Roof	196	0,09	46 cm pitched roof (30° roof angle)

The test chambers will have interior dimensions; height 3.5 m, width 3 m and a depth of 8.4 m. The large depth is chosen in order to be better able to study the effect of daylight and daylight (re)distribution systems.

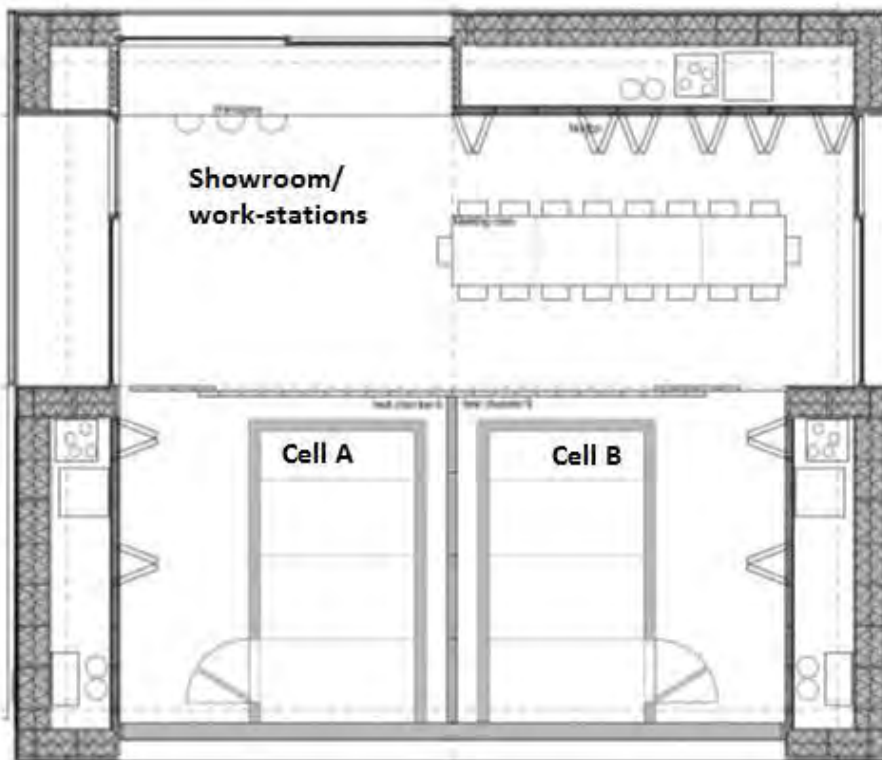

*Floor plan of the test cell. On the south side (bottom of drawing) one can see the two planned calorimetric test chambers, denoted cell A and B. On the north side a combined showroom and work space is planned.*

### Inside boundary conditions

The test chambers will have climate control where temperature, relative humidity and air pressure can be controlled. The test chambers will each have a separate HVAC system. The remaining parts of the test cell will have a common HVAC system. Additional heating and cooling in all zones of the building will be provided with electricity based systems. . A weather station will be set up adjacent to the test cell.

### Special limitations / possibilities

The south façade adjoining the test chamber facades on the south wall will be built up as one large primary surface element of 3.9 x 9.6 m (height x width) completely covering the two test chambers. This means that if for example the intention is to check different technical equipment in relation to the same façade component it is possible to place a single sample consisting of the same material without having to make any joints in the sample. Different components can be placed inside the primary structure (each of the test chambers has a façade area of 3.6 x 3 M) for experiments where different façade solutions are to be compared.

## DATA ANALYSIS

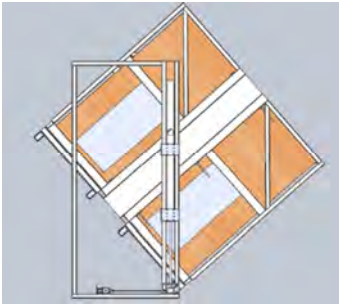

Hot box apparatus

### Typical equipment within test wall

The entire test cell will to a varying extent, be instrumented with sensors monitoring temperature, Heat flux meters humidity, wetness, moisture content, air velocity, solar radiation, ventilation flows, CO2 levels, light levels etc. The test chamber interchangeable walls will be instrumented according to demands in each experiment.

The data acquisition system will likely be built up around a logging and data acquisition system from National Instruments and their LabView software. Some exchange of knowledge and technology know-how with Lawrence Berkeley National Laboratories are planned regarding the logging system.

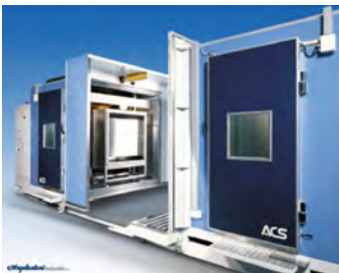

Climate simulator

## MAINTENANCE / COLLABORATION

### Personnel involved

The test cell will be maintained and operated in collaboration by personnel from NTNU and SINTEF. Trained personnel will work with software programming and set-up and skilled craftsmen will assist with instrumentation and build-up of test elements etc. Data analysis will be performed by persons with background in both theoretical building physics as well as applied building physics competence.

### Link with other devices

The test chamber interchangeable facades have the same external dimensions (width and height) as our new rotatable guarded hot box as well as our climate simulator with artificial sun, water spray temperature and humidity control. This makes it possible to make detailed studies on component level as basis for further investigation of real-climate performance combined with HVAC systems interaction in the test cell facility. This fits the test cell in to our strategy where the aim is to be able to characterize materials, components etc in the range from small to large-scale experiments following the below list:

- ✓ Advanced Material Technologies Laboratory
- ✓ Climate and Building Technologies Laboratory
- ✓ Building Services Laboratory
- ✓ Full Scale Test Cell
- ✓ Living Laboratory
- ✓ Pilot Building Measurement In Situ

# EGUZKI and ILARGI PASLINK TEST CELLS LCCE VITORIA-GASTEIZ



## GENERAL DESCRIPTION

### Main objective of the test facility

The two PASLINK test cells named EGUZKI and ILARGI are part of the equipment of the Thermal Area of the Laboratory for the Quality Control in Buildings (LCCE) of the Basque Government. The Department of Thermal Engineering at the University of the Basque Country (UPV/EHU) was appointed by the Basque Government to set up and manage the Thermal Area within the LCCE. To accomplish that goal, it was signed an agreement between both institutions.

The LCCE's Thermal Area started its activities in 1988 with thermal conductivity measurements (according to ISO 8301 and 8302). Then a guarded hot box for opaque walls (according to EN ISO 8990) was installed to measure

### Institute/organisation:



Laboratory for the Quality Control  
in Buildings  
Basque Government

### Contact person:

Aitor Erkoreka  
University of the Basque Country  
Engineering School of Bilbao  
Alameda Urquijo s/n,  
48013 Bilbao  
Tel: +34 94 601 7359  
aitor.erkoreka@ehu.es

### Exact location:

Agirrelanda Street 10,  
01013 Vitoria-Gasteiz,  
Basque Country, Spain  
42.85° N, -2.68° E

thermal transmittances, and a year later a guarded hot box for windows was installed (according to EN ISO 12567).

In parallel to the thermal testing, the LCCE also set up equipment for hygrothermal measurements:

- Water vapor permeability tests as per Standard UNE-EN ISO 12572:2002
- Capillary absorption tests as per Standard UNE-EN ISO 1548:2002
- Hygroscopic sorption tests as per Standard UNE-EN ISO 12571:2000
- Water absorption under vacuum tests as per Standard NBN B 24-213
- Mercury intrusion porosimeter: Micromeritics AUTOPORE IV
- Moisture buffering Value determination as per NORDTEST protocol, as per Standard JISA 1470-1: 2002 and as per ISO 24353:2008.

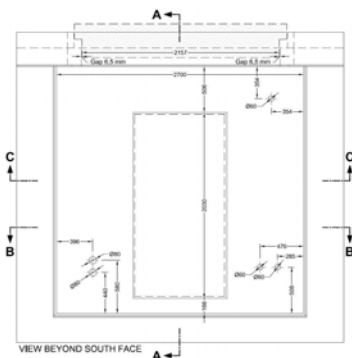

ILARGI drawings for roof samples.



Installing the insulation frame for roof samples in ILARGI.



Removing the calibration roof from ILARGI.



Installing the frame for roof samples in ILARGI.

In 2007 a need for testing the hygrothermal behavior of full size samples of new developments such as ventilated façades, new roof system, PCM walls, etc. was found. After searching in the literature, the LCCE staff found PASLINK test cells was the most developed system (both: equipment and procedures) for measuring the hygrothermal performance of this type of elements under real conditions.

### Overall lay-out

Nowadays there are two PASLINK test cells in the LCCE premises. One of them named EGUZKI can test vertical elements of 2.7 x 2.7 m while the second test cell named ILARGI can test both: vertical elements of 2.7 x 2.7 m and horizontal ones of 3.7 x 2.1 m.

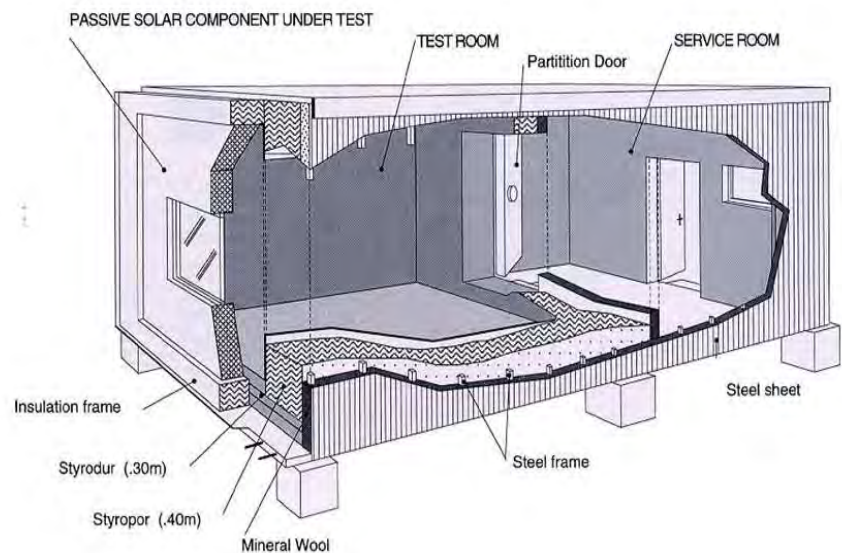

Schematic view of EGUZKI test cell. ILARGI test cell is similar but part of the roof is removable. Source: [3].



## PART 1: Facilities for outdoor testing of building components

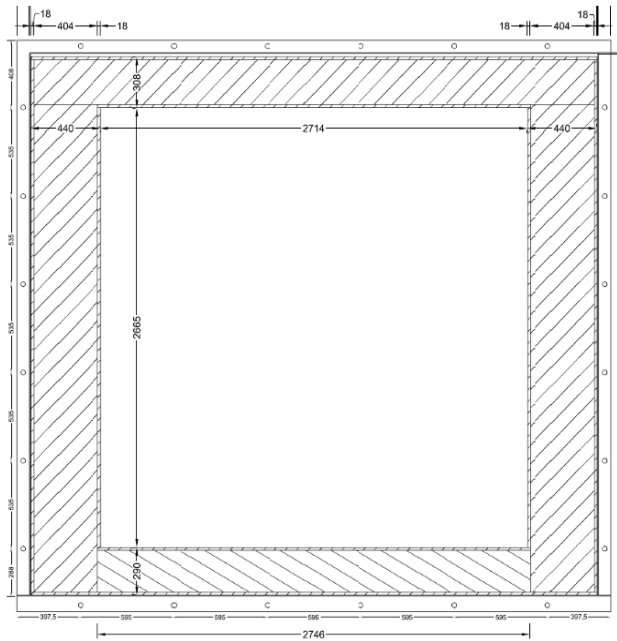

*Drawings of the insulation frame for EGUZKI test cell vertical samples. ILARGI test cell vertical samples are of similar size.*

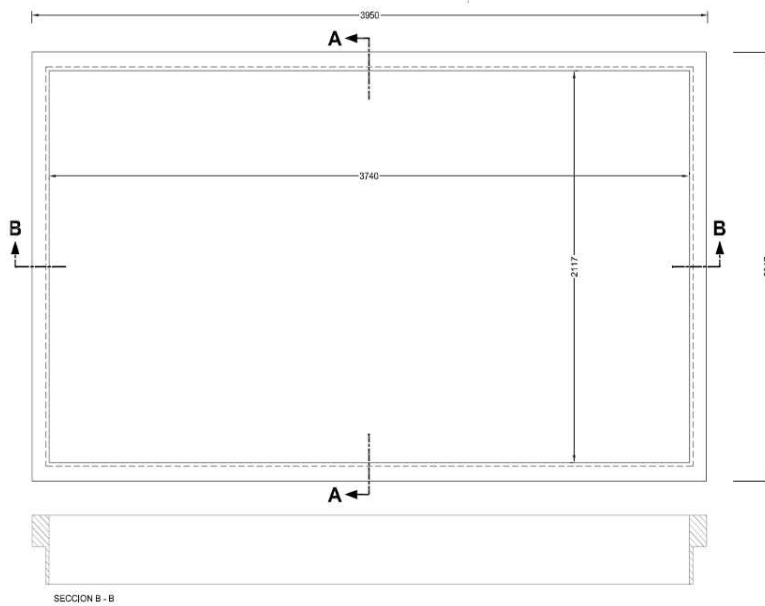

*ILARGI test cell frame for horizontal samples.*

Both test cells were bought to the Porto test site and before being used they have been upgraded following the indications provided by Dr. J.J. Bloem:

- All thermal bridges were removed: the front of the sample connection was metallic and was replaced by a wooden frame; the cooling water



Samples are constructed under controlled conditions inside the pavilion.



The pavilion has all the required facilities to construct any type of samples with the required quality under safe conditions.



Sample being transported from pavilion to EGUZKI test cell.



Sample installed in EGUZKI.



Frontal view of EGUZKI test cell without the sample. All interior sensors of the test room can be seen: 7 air Pt100 protected against radiation, blackbody temperature, 9 surface Pt100 to measure envelope walls interior surface temperature and 230 Heat Flux Sensitive tiles (HFS Tiles) covering the whole envelope except the sample. Inside the wooden box an axial ventilator and an electrical heater are located.

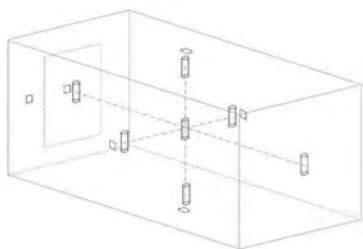

Temperature sensor location schematic inside the test room.

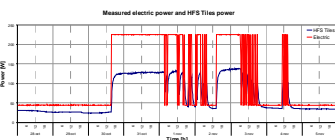

Measured electric power (red) versus HFS Tiles heat flux (blue). Considering the thermal inertias of the test room elements the heat flux through the sample can be calculated.

tubes that connected the test room and service room were removed too; the door separating the test room and the service room had a metal frame and it was changed to wood; the two large air pipes were removed, insulated and sealed because they are not needed.

- Inner wooden lining was removed and new plastic foil was installed before new and thicker inner wooden lining was installed. Air infiltration rates have become negligible and inner surface for HFS Tiles installation was improved.
- A shadow system for solar radiation on lateral walls and roof of the test cell was installed to obtain better uniformity in the heat fluxes through the envelope excluding the test sample.
- In the second test cell, roof components can also be tested. An insulation frame for the roof components have been designed and constructed. This new development was carried out entirely by the LCCE staff. It minimizes border effects and makes it easier to manipulate roof samples although they are heavy roofs.

Both test cells are facing south. The volume of the test room (38 m<sup>3</sup>) and the size of the samples are representative for real size constructions.

### Inside boundary conditions

The inside conditions are those of the test room. The interior air temperature is measured in 7 points by Pt100 sensors protected against radiation and are distributed as shown in the temperature sensor schematic. This way temperature stratification can be measured and it is maintained below 0.3°C thanks to an axial ventilator that is placed inside the wooden box, as it can be seen in the adjoined photo. Inside the box there is also an electrical heater that can be switched ON and OFF from the data acquisition program. The power consumption of both is measured by a power transducer ( $\pm 0.5$  W) very accurately. The complete envelope is covered by 230 Heat Flux Sensitive Tiles (HFS Tiles) grouped in 21 groups which measure the heat that leaves the test room through the envelope walls except through the south wall. The surface temperature of all interior walls is also measured by 9 surface Pt100 and their deviation is less than 0.9°C.

The test room is very airtight. After installing the sample a pressurization test is carried out and if the air renovation rate is below 0.5 h<sup>-1</sup> under a 50 Pa pressure difference between interior and exterior it means the air infiltration rates are negligible during the test. The pressurization test is repeated after the test procedures have been finished. If all the conditions mentioned above are accomplished, by means of an energy balance between the power transducer signal and the HFS tiles signal, we can accurately obtain the heat flux through the sample. This indirect way of measuring the heat flux through the sample makes possible to install any type of semitransparent elements in the south wall and both whole-element thermal transmittance (UA) and solar aperture (gA-value) can be calculated.

## Outside boundary conditions

Outside boundary conditions are the ones of the exterior conditions in the location of Vitoria-Gasteiz. There is a meteorological station in the site measuring air temperature protected against radiation, wind direction, wind velocity, barometric pressure, relative humidity and rain precipitation at 10m height. All these measurements are carried out by a VAISALA weather transmitter WXT510 meteorological station.

In front of the sample the air temperature is measured accurately by a Pt100 shielded against radiation and ventilated. Wind direction and wind velocity are also measured in front of the sample. There is a Kipp & Zonen CMP11 pyranometer for measuring the global solar radiation in the plane of the sample, for both vertical and horizontal samples. Apart from these pyranometers there are also two CMP11 pyranometers that measure the global horizontal and the diffuse horizontal radiation in the test site. For checking issues there are also two air Pt100 temperature sensors shielded against radiation in each test cell, one placed below the test cell and the other one in the roof under the solar shielding.

## Special limitations / possibilities

The way of measuring the heat flux through the sample in an indirect one, making it possible to test any type of vertical enclosure within the dimensions of the frame. This includes any type of semitransparent element, ventilated façades, façades using PCM... The height of one story is 2.7 m and is the maximum sample height. There was a need for calculating the thermal behaviour of a 4 story ventilated façade, so the test cell was used for calibrating a CFD model for a 2.7 m height case and that model was used thereafter for optimising the air chamber for the real size building.

The most important improvement made by the laboratory Thermal Area staff on the test cells has been the roof testing system. The original test cells were designed to remove the whole roof. In this way the roof sample installed has no insulating frame whereas the vertical samples do have. A fixed insulating frame was designed and constructed within the original roof making possible to test horizontal roof samples as accurately as vertical walls are tested. The size is not as big as to test an inclined roof so the roof testing has been limited to horizontal or very low tilted roofs. A calibration roof was also constructed in the same way as it is made for vertical samples.



EGUZKI without sample and protected with a tarpaulin. Meteorological station is located 10 m high. Air temperature, velocity and direction in front of the sample.

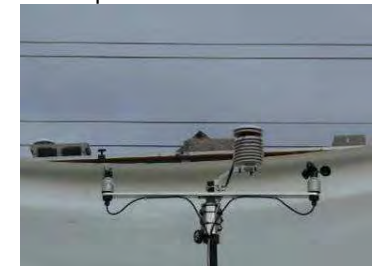

ILARGI air temperature, velocity and direction in the height of the roof.



Global solar radiation in the plane of the sample.



Global and diffuse horizontal radiation.

## DATA ANALYSIS

### Typical equipment within test wall

The sensors to measure the inside boundary conditions and the ones for outside are fixed for all tests and they are described in [1], [2] and [3]. Besides all those fixed sensors, the sample to be tested is usually equipped with Pt100 temperature sensors (air and surface), heat flux sensors, thermopiles, pressure tubes, relative humidity sensor, thermoanemometers and air flowmeters.

Depending on the sample to be tested and also on the aim of the test, the sensor types and positions are defined before the sample is constructed. The construction of the sample is done inside the laboratory pavilion. Some sensors are usually wrapped up inside the sample and they must be installed during construction.

For example a ventilated façade was tested for a modular housing company; it can be seen schematically in the adjoining column.

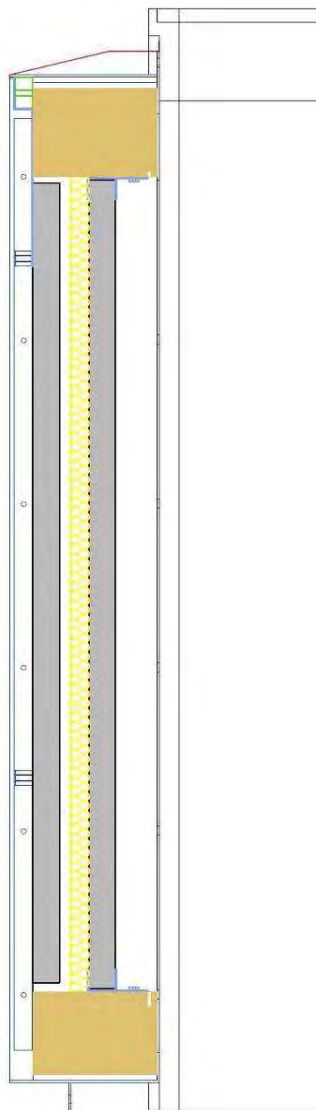

Vertical section of one ventilated façade tested in EGUZKI test cell. Left side is facing exterior and right side is facing test room. From inside to outside is composed by 4 layers: 8,5 cm concrete slab, 6 cm of mineral wool, 3.5 cm of ventilated air chamber and 8.5 cm exterior concrete slab.

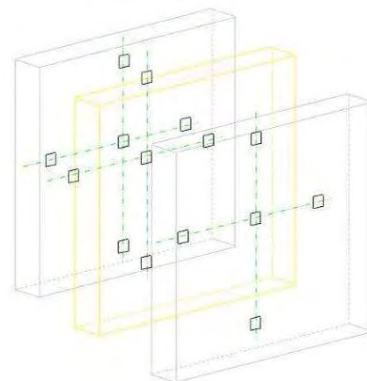

*15 Pt100 for surface temperature installed in the three interior interfaces: in both layers of insulation and in the concrete surface of the air chamber.*

For this sample the air chamber was the most important part of the test, since the test results were used to calibrate a CFD model. That is why 10 air Pt100, a thermopile and 4 thermoanemometers were installed inside the air chamber to measure the evolution of temperatures in the air as well as the mass flow in the air chamber.

## PART 1: Facilities for outdoor testing of building components

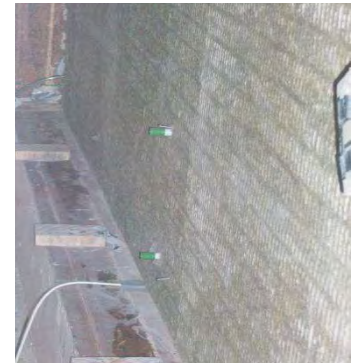
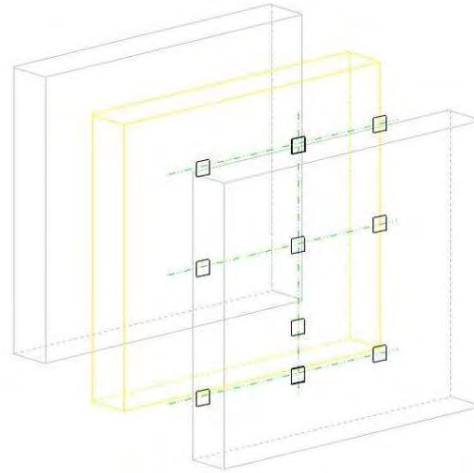

Hot wire anemometers to measure the air chamber air velocities in the central vertical axis in two different levels.

Left: Pt100 for air chamber and surface Pt100 installed below the insulation layer. Right: Distribution of air Pt100 in the air chamber.

The air chamber was also equipped with air velocity sensors and relative pressure sensors as listed below.

Name	Description	Accuracy
1AVT01	Air velocity inside the air chamber. Central vertical axis (226 cm).	± 0.01 m/s
1AVT02	Air velocity inside the air chamber. Central vertical axis (123 cm).	
1AVT03	Air velocity inside the air chamber. Central vertical axis (33 cm).	
1AVT04	Air velocity inside the air chamber. Central vertical axis (0 cm).	
1PRT01	Relative pressure between the atmospheric pressure (protected against wind) and the air chamber top level static pressure.	± 0.5 Pa
1PRT02	Relative pressure between the lower level static pressure of air chamber and the air chamber top level static pressure.	
1PRT03	Relative pressure between the lower level static pressure of air chamber and the atmospheric pressure (protected against wind).	



Closing the air chamber, wooden separators to maintain the air gap uniform. Thermopile cables in green.

### Accuracy and logging resolution

The data acquisition and control of each test cell is done by a HP Agilent 34980A which can accommodate up to 8 plug-in modules for different purposes (in our case 5 multiplexer 34921A and 1 control 34951A module). This acquisition system is placed in the service room of the test cells and all the measuring and control signals are connected to it. There is cable connection from this device to the control room where a computer stores all the data in some “dayfiles” that keep every signal recorded each minute. The software used to communicate with the HP Agilent 34980A has been developed by the LCCE laboratory staff in collaboration with a programmer

who has done the program to fit the needs for data collecting and controlling of the test cell.



HP Agilent 34980A data acquisition system for logging and controlling the PASLINK tests.

The most common and important measurements of the tests are usually the temperatures. PT100 class A 1/5DIN four wire connection are used, having different configurations depending if they are measuring air or surface temperature. In those samples where the temperature measurement must be done inside mortar layers, T Type thermocouples are employed since they are more robust. To measure differential temperatures self made and self calibrated thermopiles are used from T Type thermocouple wires. Some of the temperature instrumentation is manufactured specifically for the LCCE. These temperature sensors are calibrated in-situ using a controlled bath with an internationally traceable pattern. The measuring range is the one used in the calibration.



Each HP Agilent 34982A is connected to a computer where the data is stored and sent by email in “dayfiles” format. The third one is for the meteorological station that passes the information to the other two computers.

Instrument	Manufacturer	Model	Range	Accuracy
PT100 class A 1/5 DIN	TC S.A. Measure and Control of Temperature Spain	F217-5/SPEC-RT47-F9/CU 16-1-30-CE2L-RT47-F9/CU	-20 to 60°C	±0.2°C
Thermocouple Type T	TC S.A. Measure and Control of Temperature Spain	A14-KT-1-0.8-20.0.5	-20 to 60°C	±0.4°C
Heat flux sensors	AHLBORN S.L. German	FQA0801H	< 80 W/m <sup>2</sup>	5% at 25°C
Air velocity sensor (thermoanemometer)	AHLBORN S.L. German	FVA605TA1	0.01 to 1 m/s	±0.01 m/s
Humidity sensor	AHLBORN S.L. German	FHA6461	5 to 98% rH	± 2 %
Differential Pressure sensor	AHLBORN S.L. German	OD 8612P05	0 to 50 Pa	± 0.2 Pa



This is the interface of the developed program for logging and controlling the PASLINK tests.

The data acquisition system is very flexible and can hold most of the possible instruments needed for any specific sample. All the elements in the PASLINK test cells are connected to an UPS system located in the test room to permit a 2 hour electrical grid failure, the batteries of the computers have also 2 hour autonomy. This way the test can keep running if the electrical failure is under 2 hours.

### Analysis of the data



Calibrating temperature sensors in a controlled bath in the LCCE premises.

Data analysis is different depending on the tested element. In any case the installations, data acquisition system and control system have been designed and constructed to make possible the use of the PASLINK data analysis methodology. This data analysis methodology is developed in [1], [2] and [3] and makes possible to obtain the UA and gA values of the tested element under real conditions. It also allows to evaluate the “apparent thermal transmittance” of elements that are performing under real conditions in which air cavities can have ventilation, where dynamic behaviour is important due to the thermal inertias of the element, solar energy can be stored, etc.

LORD and CTSM are the software that have been used for most of the cases when PASLINK methodology has been applied. Nevertheless, the flexibility of the test cells is very wide and has been demonstrated with several projects carried out by different members of the PASLINK network. Depending on the specific sensors installed inside the specific tested element, different goals can be achieved. Among the tested elements, apart from the thermal behaviour, the air movement on ventilated chambers has been studied. A CFD model has been calibrated for an industrialised ventilated façade: the cavity width has been optimised taking into consideration their mechanical and acoustic restrictions. Also a model (using software for hygrothermal simulation) has been calibrated to study the hygrothermal behaviour of a flat roof: the possibilities of condensation have been measured and simulated.

## EXAMPLES OF PREVIOUS STUDIES

The setting up of the two test cells started on 2007 and it was not until June 2009 when the first test cell (EGUZKI) was calibrated. Most of the testing works have been done in this test cell:

- Active ventilated façade was tested to study the energy savings that could be obtained for non-residential buildings. The ventilated cavity was the focus of the study and the data were used for calibrating a CFD model. This work was developed as part of a coordinated R+D project funded by the Spanish Government.
- A ventilated façade with the outer skin filled with PCM material was tested, both in summer and winter, to study the behaviour of the PCM under real conditions. Also the air chamber was monitored to study its performance. This work was developed as a R+D project funded by Biscay council.
- A company that has designed a system to construct modular houses has used the test cell for testing their ventilated façade design (referred above). The aim was to evaluate the thermal behaviour of the ventilated façade and also to optimize the air cavity width. The optimization was done via a CFD model that previously had been calibrated with the test results.
- A construction material company has tested the dynamic behaviour of one of his insulating mortar. This mortar has been used as an insulating material in a traditional façade and the “apparent U value” under real conditions has been calculated. Thermal inertias of the different layers have been calculated.



Active ventilated façade for non-residential buildings.



Ventilated façade with outer skin filled by PCM.



Insulating mortar projection.



Window system with solar energy accumulator.



IQ-TEST opaque wall.



IQ-TEST window.



ILARGI: Frame for roof samples.



ILARGI: installing the roof covered by gravel to be tested inside the frame.

- The University of Navarre has contracted the LCCE to test a window system with solar energy accumulator in the EGUZKI test cell. This development was obtained as the result of a R+D project. We have tested their element in different seasons and in different operational modes, obtaining UA value and gA values for these different operational modes.
- Apart from the calibration of the test cell, the IQ-TEST round robin test has been carried out in the EGUZKI test cell to evaluate if the test cell and the data analysis have been implemented properly in the test site. IQ-TEST description on [9] and [10].

The second test cell (ILARGI) has been calibrated by the end of June 2010. Only one test has been carried out in this cell. The calibration roof has been replaced by a flat roof sample designed by the same company that tested the ventilated façade for modular houses. A roof covered with gravel has been tested and the U value and the thermal capacity of the roof have been obtained. A Wufi model has been calibrated with the test data and used to advise for the need of vapour barriers and their optimal placement. Also the hourly annual energy demand per m<sup>2</sup> of roof has been calculated for the several zones considered in the Spanish Technical Building Code. As a next step the gravel cover will be substituted by a green roof and its thermal behaviour will be studied during 2011.

## MAINTENANCE / COLLABORATION

### Personnel involved

The Thermal Area staff of the LCCE is responsible of the test site. The full time members of the staff are engineers and technicians. There are also part-time members of the staff who are researchers from the Department of Thermal Engineering at the University of the Basque Country.

The technicians are the ones that make the control during the sample construction and testing. They are responsible for the quality during the construction of samples and they are also in charge of installing all the instrumentation on them. Calibration of sensors and supervision of the measuring and control system is also their responsibility. Common maintenance work is their responsibility but always guided by the engineers.

The full time engineers of the LCCE are the ones to make the data analysis and reporting for contracted tests. The part-time staff from the University of the Basque Country is involved in the development of the test cells and data analysis for some of the research projects. Some of them are doing their PhD with projects related to these activities.



### International collaboration

Dr. J. J. Bloem from ISPRA Joint Research Centre has visited the test site several times to check the setting up of both test cells. He is the one who has guided the improvements based in his wide experience with PASLINK test cells. During the first steps of the test site no specific international collaboration with other test sites has been possible.

### Link to other devices

The PASLINK test cells have been the last step forward made by the Thermal Area of the LCCE laboratory. It has followed a logical evolution starting from the knowledge of materials (thermal conductivity) until the hygrothermal behaviour under real conditions of real size samples. The hygrothermal behaviour of specific materials can also be tested in the laboratory by the different measurements described in the first part of this document.

The link to the guarded hot box for windows and walls is direct. The IQ-TEST window was tested previously in the hot box apparatus and similar results for the U value were obtained in the PASLINK test cell. The same procedure was followed with a concrete opaque wall tested in both, the guarded hot box equipment and in the PASLINK test cell, obtaining similar U values. The hygrothermal measurements have been accomplished only in the roof sample and they have given us satisfactory information.



Heat flow meter apparatus (according to EN ISO 8301)

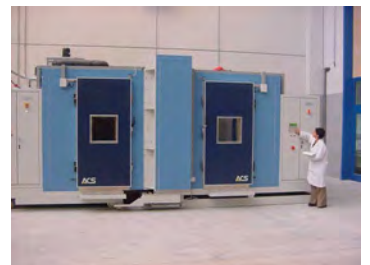

Guarded hot box for opaque walls (according to EN ISO 8990)



Guarded hot box for windows (according to EN ISO 12567)

## RELEVANT LITERATURE

### General literature about the test facility:

- [1] Van Dick, H.A.L. and Van Der Linden, G.P. *PASLINK Calibration and component test procedures*. TNO, Delft, 1995.
- [2] Van Dick, H.A.L. and Tellez, F. *COMPASS Measurement and data analysis procedures*, WTCB-CSTC, Brussel, 1995.
- [3] Van Dick, H.A.L. *Development of the PASSYS test Method*, BBRI & European Commission - Directorate - General XII, EUR 15113 EN, Brussels, 1994.
- [4] Hahne, E. and Pfluger, R. *Improvements on PASSYS test cell*. *Solar Energy*, Vol. 58, n 4-6, (1996), pp. 239-246.

- [5] Saxhof, B. *PASLINK calibration manual*, Technical university of Denmark, 1995.
- [6] Van der Linden, G.P., Van Dick, H.A.L., Lock, A.J., van der Graaf, F. *Installation Guide for HFS Tiles for the PASSYS test cells*, WTCB-CSTC, Brussel, 1995.
- [7] Saxhof, B. *PASLINK calibration manual*, Technical university of Denmark, 1995.
- [8] Van der Linden, G.P., Van Dick, H.A.L., Lock, A.J., van der Graaf, F. *Installation Guide for HFS Tiles for the PASSYS test cells*, WTCB-CSTC, Brussel, 1995.
- [9] Baker, P.H., *WP3 Spec for component - 1.doc*, 2000. (IQ-Test internal report)
- [10] Heimonen, I. *Test Report on Round Robin Components*, VTT Results, WP3 IQ-Test, Finland, June 2002. (IQ-Test internal report)

### Literature on previous measuring campaigns:

- [11] Escudero, C., Erkoreka, A., Garcia, C., Flores, I., Martin, K. *Puesta a punto y objetivos a cumplir de una célula de ensayos PASLINK*, VI Jornadas Nacionales de Ingeniería Termodinámica, Cordoba, June 2009.
- [12] Erkoreka, A., Flores, I., Escudero, C., Martin, K., Sala, J.M<sup>a</sup>, *Importance of testing the thermal performance of façades and roofs under real conditions*, XXIX summer courses UPV/EHU San Sebastian - XXII European Courses, June 2010.
- [13] Erkoreka, A., Escudero, C., Flores, I., Garcia, C., Sala, J.M. *Upgrading and calibration of two PASLINK test cells. Evaluation through the "IQ-TEST" round-robin test*, DYNASTEE workshop on Dynamic Methods for Building Energy Assessment, October 11 - 12, 2010, BRUSSELS
- [14] Erkoreka, A., Flores, I., Escudero, C., Garcia, C., Sala, J.M. *Thermal characterization of ventilated facades under real conditions using PASLINK test cells*, XXXVII IAHS World Congress on Housing, October 26 - 29, 2010, Santander, Spain

# LECE-UiE3-CIEMAT



## GENERAL DESCRIPTION

### Main objective of the test facility

The Building Component Energy Test Laboratory (LECE), one of the facilities at the “Plataforma Solar de Almería” (PSA), is part of the Energy Efficiency in Building R&D Unit (UiE3) in the CIEMAT Energy Department’s Renewable Energies Division.

The UiE3 carries out R&D in integral energy analysis of buildings, integrating passive and active solar thermal systems to reduce the heating and cooling demand. This unit is organised in three lines of research focusing on: 1.- Energetic Analysis of Buildings by simulation, 2.-Study of Passive Systems in Buildings and Urbanism, and 3.-Experimental Energy Evaluation under Real Conditions. The test facilities described are under the last of these.

### Institute/organisation:



Energy Efficiency in Buildings Unit  
CIEMAT. Spain

### Authors:

S. Castaño, J.D. Guzmán,  
M.J Jiménez\*, M.R. Heras

### \*Contact:

tel: 34950387800; Ext.: 922  
e-mail: mjose.jimenez@psa.es

### Exact location:

Tabernas (Almería), Spain  
37.1 °N, 2.4 °W

The Group's activities are largely experimental, focusing in energy performance calculation of buildings and building components.

These activities are carried out in the LECE's Outdoor Laboratory at the Plataforma Solar de Almería (PSA) and the PSE ARFRISOL Research Energy Demonstrator Office Building Prototypes (C-Ddl), one of which is also at the PSA.

The LECE has several systems for studying actual-size construction systems experimentally under real weather conditions, using data analysis, system identification and time-series-analysis techniques. These experimental systems are the PASLINK and other test cells, the Solar Chimney, and Monozone Building.

In addition, the LECE infrastructure is prepared for the integration of new experimental prototypes that can be incorporated according to the needs of the Group's future research projects.

LECE activities may be classified as:

- Experiments in the CIEMAT Energy Efficiency in Building R&D Unit's research projects.
- Collaboration with and services for building materials and component manufacturers.
- Experimental support for preparation of standards and regulations.

## Overall devices layout

The test facility integrates several devices with different capabilities as summarised below:

### Test cells.

The LECE has three conventional test cells, each of them made up of a high-thermal-insulation test room and an auxiliary room. These facilities are located in a large open area without any shading and separated from each other enough to not be affected.

The south wall of the test chamber is formed by the component to be tested covering it completely.

The cells are all equipped with air conditioning systems and instrumentation for testing full-scale building components.

### PASLINK Test cell

The Spanish PASLINK test cell incorporates the Pseudo-Adiabatic Shell (PAS) Concept. This system detects heat flux through the test cell envelope by means of a thermopile system, and compensates it by a heating foil device. The inner surface in the test room consists of an aluminium sheet which makes it uniform to avoid thermal bridging. It also has a removable roof that

## PART 1: Facilities for outdoor testing of building components

enables horizontal components to be tested. The cell is installed on a rotating device for testing in different orientations.

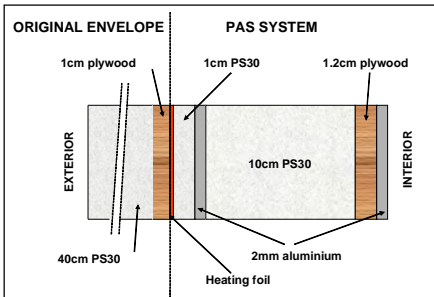

*Schematic drawing of the PAS system*



*Detail of the rotating device*



CIEMAT's PASLINK test cell



CIEMAT's PASLINK test cell

### CETeB Test cell.

This is a new test cell for roofs. The design of this test cell solves some practical aspects related to roof testing, such as accessibility and structural resistance. An underground test room allowing easy access to the test component is used for this.

The design of the test chamber takes into consideration the following points:

- Accessibility to the roof tested, having about 1m height from the ground level, facilitating installation, supervision and maintenance.
- Support structure sturdy enough to test any type of roof.
- Test room thermally insulated and sealed with respect to the outside.
- Flexible heating and cooling equipment and controllable from the data acquisition system and measured power supplied.



Interior of the CETeB Test cell

### Solar Chimney.

This is a real size solar chimney prototype, built in 2003 and monitored since its construction under real weather conditions. This was constructed for empirical modelling experiments and validating theoretical models.

The dimensions of the solar chimney absorber wall are 4.5m high, 1.0m wide 0.15m thick with a 0.3-m-deep air channel and 4mm thick glass cover. Both the inlet and outlet area is 0.25m<sup>2</sup> and the air inlet is located at a height of 0.5m from the floor. The inlet air flow is collimated by a laminated array so that the air flow is in the x-direction only.

### Monozone building.

This is a small workshop, 31.83 m<sup>2</sup> area, and the following external dimensions: 4.60m wide, 6.95m long and 3.65m. It is a monozone area building and constructed in an open area free of other buildings and obstacles around that could shade it except for a twin building located 2 m from its east wall.



Exterior of the CETeB Test cell



Solar Chimney

The building was designed to reduce energy demand in both winter and summer using the following passive techniques:

- South orientation.
- Fixed shading devices for solar control, that avoid solar gains in summer and maximise them in winter.
- Double-glazed windows.
- Windows diagonally placed in a north-south arrangement in order to produce natural ventilation
- Building envelope including thermal mass.
- External insulation
- High ceilings

Its simplicity facilitates detailed exhaustive monitoring and setting specific air conditioning sequences, that simplify its analysis for in-depth development and improving experimental energy evaluation methodologies for buildings.

### The PSE ARFRISOL C-DdIs



Monozone building. South face

This building is fully instrumented Energy Research Demonstrator Office Building Prototypes which are in use and monitored continuously by a data acquisition system. The CIEMAT owns 3 of 5 of these “Contenedores Demostradores de Investigación, C-DdIs” (Research Energy Demonstrators Building Prototypes), built under the ARFRISOL Project. Each of them is an office building with approximately 1000m<sup>2</sup> built area. One of them is also at the PSA and the others in different locations representative of Spanish climates. These C-DdIs are designed to minimize energy consumption by heating and air-conditioning, whilst maintaining optimal comfort levels. They therefore include passive energy saving strategies based on architectural and construction design, have active solar systems that supply most of the energy demand (already low), and finally, conventional auxiliary systems to supply the very low demand that cannot be supplied with solar energy, using renewable energy resources, such as biomass insofar as possible.



Monozone building. North face

These prototypes were built for high-quality measurements recorded during monitoring to support research activities on thermal comfort, building energy evaluation and both active and passive systems integrated in the buildings.

### Typical Measurement devices

This section describes the measurement devices and the way how these elements are installed which is crucial to guarantee a good representation of the measurements.

Most measurements are based in PASLINK specifications. Some improvements have been introduced taking into account modernised technical possibilities, and optimisations according the local climate conditions.



The PSE ARFRISOL C-DdIs: Office building prototype in occupancy conditions

## PART 1: Facilities for outdoor testing of building components

### Air temperature

Platinum thermoresistance, PT100, 1/10 DIN, directly measured using a four-wire connection, with a solar radiation shield and ventilated for outdoor measurements. A metallic cylinder 3mm diameter and 150mm length is used for indoors measurements. A protective ventilated holder is used for outdoor measurements.

### Surface temperature

For surface measurement an element model 2.1252.000 manufactured by Thies Clima is used. The measuring element is a platinum thermo-resistor Pt100, IEC 751 accuracy of  $\pm 0.5^{\circ}\text{C}$ , embedded between two 0.05mm thick polyimide foils. Due to its very thin construction it is very flexible and has very small mass, so that it can be integrated in the measured surface minimising the perturbation due to its presence. The dimensions of this element are 50mm x 21mm x 0.2mm with a weight of 2g. It is also directly measured using a four-wire connection

### Global Solar Irradiance

The used device is a pyranometer, model CM11 manufactured by Kipp&Zonen, secondary standard according ISO 9060:1990. Presently this equipment is one of the most widespread equipment for these measurements. voltage output is directly measured using a differential connection.

### Longwave Radiation

Pyrgeometer, model CGR4 manufactured by Kipp and Zonen, voltage output is directly measured using a differential connection. It incorporates a PT100 sensor to measure housing temperature which is directly measured using a four-wire connection.

### Wind speed and direction

Model Windsonic, manufactured by GILL INSTRUMENTS LTD. WindSonic is a 2-axis ultrasonic wind sensor, providing wind speed and direction data via two analogue outputs, with accuracy  $\pm 2\%$  in wind speed and  $\pm 3^{\circ}$  in wind direction. 4..20mA outputs are directly measured. It has a very robust structure and low volume.

### Heating power

Vatimeter model SINEAX DME 440 manufactured by Camille Bauer, class 0.25 to IEC 688:1992, 4..20mA output directly measured

### Heat flux density

Sensor model HFP01 manufactured by Hukseflux, accuracy of sensitivity coefficient 5%, voltage output measured directly by differential connection.



Shielding device for measurement of indoor air temperature



Pt100 used for surface temperature measurements



Pyranometer. CM11 Kipp&Zonen



Pyrgeometer. CGR4 Kipp&Zonen



Used anemometer. Gill WindSonic 3



Heat flux meter. HFP01

This device is based on a thermopile embedded within a black plastic material. Its appearance is that of a wafer of the following dimensions: 80 mm in diameter and 5mm thick. The thermopile is in its central part, having a square area of 25 mm side. The thermal conductivity of the plastic material is 0.25W/mK.

### Data Acquisition and Control System

A data acquisition system with the following characteristics has been implemented: 16-bit A/D resolution, range of measurements fitting sensor outputs, modules distributed to minimise wiring, based in Compact Field Point modules manufactured by NATIONAL INSTRUMENTS. Particularly the following list summarises the used modules

- cFP-RTD-124: Four-Wire RTD and Resistance inputs. Range  $-200\text{ }^{\circ}\text{C}$  to  $850\text{ }^{\circ}\text{C}$  used for measurement of temperature.
- cFP-RTD-125: Differential thermocouple or millivolt inputs. Range  $-20\text{ mV}$  to  $80\text{ mV}$  used for measurement of global and long wave radiation and heat flux density.
- cFP-RTD-111: Milliamp input. Range  $4\text{--}20\text{ mA}$  used for measurement of wind speed.
- cFP-RTD-110: Voltage or current input. Range  $0\text{--}1\text{ V}$  used for measurement of relative humidity.

These modules perform A/D conversion of the signals. Digital information is transmitted through the Ethernet network from the test area to a computer that monitors, records and manages these data.

The data acquisition modules are Ethernet networked (no direct Internet connection) with each other and with a computer in which data can be displayed, recorded and managed by a LabVIEW application. Data are stored in two separate hard disks and a central server, which is backed up back periodically. The computer is synchronized with a time server and GMT time is used avoiding the official time changes. Data are recorded every minute.

### Wiring

A distributed system has been chosen in order to minimize the length of cables that transmit analog signals, minimizing in this way the uncertainties that could be due to the cable.

- Data acquisition modules are installed in the test area also to minimize the length of the cables which transmit analog signal.
- All voltage outputs are measured directly by differential connections.
- All platinum thermoresistances, PT100, are directly measured using four-wire connections.



Data Acquisition and Control System



- Shielded and twisted wire pairs are used for the transmission of analog signals to prevent interferences.
- The use of converters is avoided because they introduce an additional source of uncertainty.
- Every end of each cable has been identified to avoid wiring errors. Different pairs of colours have been used for each type of signal.
- The used colour code is the same for all the tests in the test facility, simplifying wiring.
- Joints in cables have been avoided as possible. When not avoidable, welding is wrapped with heat-shrinkable material.
- The cable ends are covered with connection terminals to prevent noise by bad connection problems.



Wiring and connections

## TESTING METHODOLOGY

Measurement points are decided for each particular case, according to the characteristics of the component and the purpose of the test, in line with the general idea that all physical quantities that contribute to the heat exchange in the test system must be quantified.

Additionally to the measurements points that are implemented to fit the analysis requirements, some other measurement points are included for qualitative verifications, to check quality of measurements, the validity of simplification hypothesis, etc.

For testing new building prototypes in research context, redundancies are included in experiment set up to fit research objectives.

### Inside boundary conditions

In the **test cells**, tests are carried out with a pre-set heating regime, including high power, low power, and dynamic power subsequences, according to a Randomly Ordered Logarithmically distributed Binary Sequence (ROLBS). This sequence provides test conditions such as a high enough temperature difference across the test specimen, avoiding correlation with diurnal incident solar radiation swings, and sufficient dynamic information. In these conditions tests in short periods are possible, typically two weeks long.

The test cell is carefully sealed before each test to eliminate infiltrations. Airtightness is checked by pressurisation tests before and after each test. Tracer gas measurements are also taken during the test, but only to estimate the contribution to the uncertainty budget.

In **real buildings**, testing is done simultaneously with its normal use. Indoor conditions are usually within the comfort limits and longer periods of analysis are considered.



Ceramic ventilated façade being tested in a test cell.



Different devices measuring outdoor air temperature, using natural and forced ventilation



Devices measuring solar global and diffuse, and longwave radiation

## Outside boundary conditions

Testing is done under outdoor weather conditions. Meteorological sensors are installed at the test site. Some of the main physical quantities are measured with redundancies for good representation.

The following meteorological sensors are installed: Global, horizontal, and south vertical solar radiation, air temperature, longwave radiation, wind speed and direction, relative humidity and concentration of CO<sub>2</sub>.

## Special limitations / possibilities

In principle, tests of thermal performance of building components are tested in the PASLINK test cell. Some restricted tests of opaque and homogeneous walls which allow installation of heat flux sensors on the inner surface are carried out using the original PASSYS test cell or the Spanish CESPAS test cells (similar).

In PASLINK test cells, due to the particular climate conditions at the test site, usually sunny with cold winters and warm summers, some of the usual analysis assumptions cannot be applied, and special considerations are necessary. One of the effects which require special hypotheses to achieve satisfactory results is longwave heat exchange on inner surfaces heated by solar radiation. Advanced tools for dynamic analysis and nonlinear models have been applied to solve such problems, and lessons learned have since been very useful in the analysis of other systems where energy saving in warm and sunny climates is of great interest.

Other devices have been added to the test site to fit the requirements of the research projects being carried out by the group. One of the main topics is the analysis of natural heating and cooling techniques. The experimental solar chimney, ventilated test façades, and the new test cell to test roofs, have been built for this purpose.

Another of the main topics of research of this group is experimental energy analysis of buildings. The elements of the test site that support this activity are a monozone building (30 m<sup>2</sup>) and an office building prototype which is in use (1000m<sup>2</sup>).

## Traceability

All the information about, the configuration of the data acquisition system and sensors used, is recorded in tables including all relevant information to guarantee traceability of measurements, location and identification of each sensor and corresponding channels, wires, conversions from each electrical output to physical quantities, etc. A table, as the one shown below, including

## PART 1: Facilities for outdoor testing of building components

all this information is generated for each of the modules of the data acquisition system. These tables are recorded together with the data files.

ROUND ROBIN EXPERIMENT					
Slot: 1 NI cFP-AI-110 (n/s 142C192)					
Name	Signal	Channel	Wire	Equipment	Information
Oi_glazing	±65mV	0	1 white	Hukseflux HFP01 S/N 002564 -new, first use-	Thermo flux sensor, Thermopile type, Ø80mm, 5mm thick, 5% error Sensitivity: 62.9 µV/W·m <sup>2</sup> Conversion factor: 15 898.25 W·m <sup>-2</sup> /V Calibration Date: 30-11-2007 Installation: Inside glass surface centred, X= cm Y= cm
			18 green		
Oi_left	±65mV	1	3 white	Hukseflux HFP01 S/N 002568 -new, first use-	Thermo flux sensor, Thermopile type, Ø80mm, 5mm thick, 5% error Sensitivity: 65.8 µV/W·m <sup>2</sup> Conversion factor: 15 197.57 W·m <sup>-2</sup> /V Calibration Date: 30-11-2007 Installation: Inside box surface left centred, X= cm Y= cm
			20 green		
Oi_back	±65mV	2	5 white	Hukseflux HFP01 S/N 003439 -new, first use-	Thermo flux sensor, Thermopile type, Ø80mm, 5mm thick, 5% error Sensitivity: 65.5 µV/W·m <sup>2</sup> Conversion factor: 15 267.18 W·m <sup>-2</sup> /V Calibration Date: 04-02-2009 Installation: Inside box surface back centred, X= cm Y= cm
			22 green		
Oi_right	±65mV	3	7 white	Hukseflux HFP01 S/N 003440 -new, first use-	Thermo flux sensor, Thermopile type, Ø80mm, 5mm thick, 5% error Sensitivity: 68.2 µV/W·m <sup>2</sup> Conversion factor: 14 662.76 W·m <sup>-2</sup> /V Calibration Date: 04-02-2009 Installation: Inside box surface right centred, X= cm Y= cm
			24 green		
Oi_ceiling	±65mV	4	9 white	Hukseflux HFP01 S/N 003438 -new, first use-	Thermo flux sensor, Thermopile type, Ø80mm, 5mm thick, 5% error Sensitivity: 65.4 µV/W·m <sup>2</sup> Conversion factor: 15 290.52 W·m <sup>-2</sup> /V Calibration Date: 04-02-2009 Installation: Inside box surface ceiling centred, X= cm Y= cm
			26 green		
Oi_floor	±65mV	5	11 white	Hukseflux HFP01 S/N 003435 -new, first use-	Thermo flux sensor, Thermopile type, Ø80mm, 5mm thick, 5% error Sensitivity: 68.1 µV/W·m <sup>2</sup> Conversion factor: 14 684.29 W·m <sup>-2</sup> /V Calibration Date: 04-02-2009 Installation: Inside box surface floor centred, X= cm Y= cm
			28 green		
Gv	-20 a 20mV	6	13 red	Kipp&Zonen CMP-11 S/N 090839 -new, first use-	Pirnometer 5% error Sensitivity: 8.30 µV/W·m <sup>-2</sup> Conversion factor: 120 481.93 W·m <sup>-2</sup> /V Calibration Date: 24-04-2009 Installation: Vertical, same plane that box's window, cm from floor.
			30 blue		
Pi_heat		7	15 red	Kainopus 440B Camille Bouer AG S/N 0000	Vatimeter, . 0.25% error
			32 black		

All critical information, event and observations that could occur to the test component, data acquisition system, boundary, etc., while testing, is also recorded together with data files.

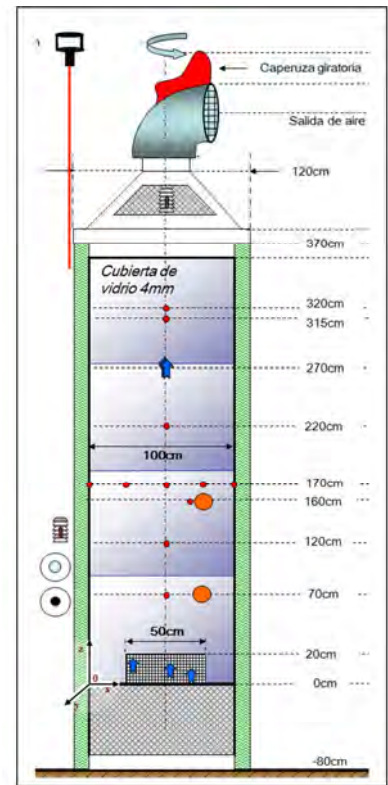

Graph with equipment installation layout of the Solar Chimney

## DATA ANALYSIS

### Analysis of the data

Applied analysis depends strongly on the purpose of the tests and also on the characteristics of the test object, ranging from averaging methods to dynamic approaches traditionally considering linear and time invariant parameters, and more recently including nonlinear and time-dependent parameters. In all cases, validation of results takes physical coherence of results into account.

Averaging methods are restricted to quite simple components or simplified test conditions (example: using a shading screen to avoid solar radiation incident on the component). These methods usually require a very long period of testing. In some cases, this is because high thermal inertia leads to a long period of integration. In other cases, in components with less thermal inertia, effects such as wind speed, longwave radiation, or solar irradiance in sunny weather, may become non-negligible, and make necessary the use of multi-linear regressions in which the increase in the number of inputs leads to longer test periods in order for there to be enough degrees of freedom for regression.

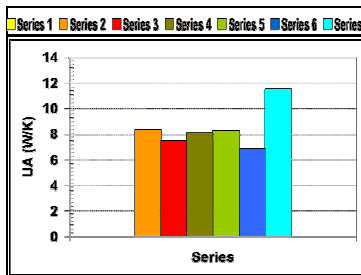

Example: Window component tested in a test cell. Test conditions in series: 1 to 5 in summer, 6 and 7 in winter. 2 to 6 with test cell facing north. 1 and 7 with test cell facing south. Using model based on traditional assumptions leading to results seriously conflicting with physical feasibility

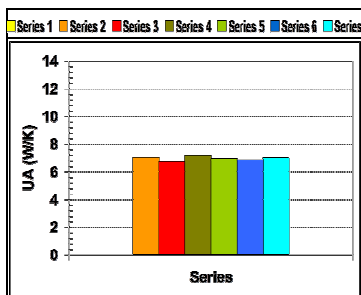

Example: Same test as above. Using model considering longwave heat exchange on inner surfaces of the test cell as boundary condition leading to very consistent parameter estimates.

Dynamic methods, frequently with linear parameters, are very useful for overcoming some of these problems. Recent studies have shown the flexibility and usefulness of dynamic nonlinear models, particularly for dealing with problems related to warm sunny weather in this test facility. Nonlinear models have been successfully applied to such cases as ventilated photovoltaic modules, solar chimneys and also for taking the boundary conditions in a test cell into account. Models including time-dependent parameters have also been applied successfully for finding the characteristic values of a wall before and after energy refurbishment.

These results show enormous potential for the analysis of systems including cooling strategies, such as longwave radiation, natural ventilation, etc. Many of these strategies are based on nonlinear physical processes. This becomes more relevant when these effects are maximized to optimize performance in energy savings strategies, which at the same time highlight the insufficiency of linear models in such cases.

## EXAMPLES OF PREVIOUS STUDIES

The test facility has recently been used to experimentally support the following studies:

- Experimental energy analysis of empty monozone reference building applying system identification tools. The analysis focused in the effect of heat exchange with the soil. (Ph. D Thesis B. Porcar. 2009).
- Analysis of heat transfer in a Solar Chimney with turbulent air flow. The solar chimney was used to validate the proposed model. (Ph.D Thesis J. Arce. 2008).
- Analysis of heat transfer in a Solar Chimney. The solar chimney was designed and used to validate the proposed model. (Ph.D Thesis J. Martí. 2006).
- Analysis of opaque and window components tested in a test cell. Proposal for uncertainty estimation according GUM, analysis of problems related to tests in sunny weather and solution of these problems. (Ph.D Thesis M.J. Jiménez. 2005).

This facility has been in use since 1989 for CIEMAT services to external clients and funded research projects. Many of these projects deal with developing and setting up the test facilities and tests procedures. Some supported by the EU were: PASSYS II (1989-1992), COMPASS (1992-1995); PASLINK (1992-1994), PV-HYBRID-PAS (1996-1998), IQ-TEST (2000-2003), etc.

In other projects, the test facility participated by giving experimental support to research, such as PASCOOL (1992-1995) about Passive Cooling, APISCO (1996-1998) analysing the effect of plants in thermal comfort, and ARCHINT (1999-2001) on architectural integration of solar collectors.

The following projects are currently in progress:

- Experimental set up and analysis of five occupied 1000-m<sup>2</sup> fully monitored, energy demonstration and research office building prototypes. One of them is at the PSA test site. Running and 2 year's data are available in the framework of the PSE-ARFRISOL project on Bioclimatic Architecture and Solar Cooling (Supported by R&D Spanish National Plan Ministry of Science and Innovation, 2005-2012).
- Experimental set up and analysis of 2 twin empty, fully monitored, 250-m<sup>2</sup> energy demonstration and research residential building prototypes each. Installation of the monitoring system is underway. In the framework of the EDEA project (Efficient Development of Eco-Architecture: Methods and Technologies for public Social Housing Building in Extremadura, Spain). European Financial Support LIFE+97. 2009-2012.
- Experiment set up and analysis of an occupied, 5000-m<sup>2</sup> fully monitored, energy demonstration and research office building prototype. Installation of the monitoring system is underway. In the framework of the Innpacto CELSIUS Project. (Supported by PLAN E from the Spanish Ministry of Science and Innovation). 2010-2013.

## MAINTENANCE / COLLABORATION

### Personnel involved

The experimental set up, including sensors and data acquisition systems and their operation, and data analysis are done by the CIEMAT Energy Efficiency in Building Group. Test components in test cells are usually installed by the manufacturer of the component. Exceptionally large installations for monitoring actual-size buildings are contracted. Also exceptionally, other technical assistance, such as carpenters and plumbers, is contracted. Work done by such external assistance always follows CIEMAT's detailed technical specifications.

### International collaboration

CIEMAT has participated in European projects on characterisation of building components, such as PASSYS II and COMPASS, since 1989. It has been a member of PASLINK EEIG since its creation in 1995. It is presently participating in INIVE Network through the DYNASTEE platform. During this

time it has participated actively in all these activities, mainly in those related to data analysis.

This test facility, as part of the facilities of the PSA, was included in the TMR (Training and Mobility of Researchers, 1996-1998) and IHP (Improving Human Potential, 2000-2003) programmes funded by the EU. These programmes provided access to the PSA free of charge for user groups or individuals throughout the Member States of the European Union and Associated States. Users were provided with infrastructure, logistical, technical and scientific support.

### [Link to other devices](#)

The test facility makes use of the excellent infrastructure for solar applications at the PSA, which belongs to the Centro de Investigaciones Energéticas Medioambientales y Tecnológicas (CIEMAT), the largest European centre for research, development and testing of concentrating solar technologies.

## RELEVANT LITERATURE

### General literature about the test facility:

The PASSYS Services. Summary report of the PASSYS Project. Eds. P. Wouters, L. Vandaele, BBRI, EC DG XII, Brussels, 1994. EUR 15113 EN.

Hybrid Photovoltaics in Buildings. CD-ROM. 2000. Results from the European JOULE project PV-HYBRID-PAS (JOR3-CT96-0092, 1996-1998). Co-ordinated and executed by PASLINK EEIG.

[www.arfrisol.es](http://www.arfrisol.es), in Spanish. Last viewed 30<sup>th</sup> April 2013.

M. J. Jiménez, R. Enríquez, R. Olmedo, N. Sánchez, M.R. Heras. 2010. In Spanish. *"Monitorización energética de los C-Ddls del PSE-ARFRISOL. Diseño experimental"*. Presented at congress: "I Congreso sobre Arquitectura Bioclimática y Frío Solar". Aguadulce, Almería, Spain. 23-26 March 2010. ISBN: 978-84-693-5141-3.

### Literature on previous measuring campaigns:

J. Arce, J. Xamán, G. Alvarez, M.J. Jiménez, R. Enríquez, M.R. Heras. 2013. A simulation of the thermal performance of a small solar chimney already installed in a building. *Journal of Solar Energy Engineering, Transactions of the ASME*. 135(1), art. no. 11005.

I. Naveros, M.J. Jiménez, M.R. Heras. 2012. Analysis of capabilities and limitations of the regression method based in averages, applied to the estimation of the U value of building component tested in Mediterranean weather. *Energy and buildings*. 55. pp. 854-872.

R. Enríquez, M.J. Jiménez, M.R. Heras. 2012. Analysis of a solar office building at the South of Spain through simulation model calibration. *Energy Procedia*. 30, pp. 580-589.

## PART 1: Facilities for outdoor testing of building components

R. Enríquez, L. Zarzalejo, M.J. Jiménez, M.R. Heras. 2012. 2009. Ground reflectance estimation by means of horizontal and vertical radiation measurements. *Solar Energy*. 86(11), pp. 3216-3226.

J. Arce, M.J. Jiménez, J.D. Guzmán, M.R. Heras, G. Alvarez, J. Xaman. 2009. Experimental study for natural ventilation on a solar Chimney. *Renewable Energy*. 2009. 34(12), pp. 2928-2934.

J. Arce, J. Xaman, G. Alvarez, M.J. Jiménez, M.R. Heras. 2009. A parametric study of conjugate heat transfer of solar chimney. *Proceedings of the ASME Energy Sustainability 2009 Conference*. San Francisco California (EEUU), 19-23 de July 2009. ISBN: 978-0-7918-3851-8.

M. J. Jiménez, B. Porcar and M. R. Heras. 2009. Application of different dynamic analysis approaches to estimate the U value of building components. *Building and Environment*. 44(2), pp. 361-367.

M. J. Jiménez, B. Porcar, M. R. Heras. 2008. Estimation of UA and gA values of building components from outdoor tests in warm and moderate weather conditions". *Solar Energy*. 82(7), pp. 573-587.

M.J. Jiménez, H. Madsen, K.K. Andersen. 2008. Identification of the Main Thermal Characteristics of Building Components using MATLAB. *Special issue on Outdoor testing, analysis and modelling of building components*. *Building and Environment*. 43(2), pp. 170-180.

M.J. Jiménez, H. Madsen. 2008. "Models for Describing the Thermal Characteristics of Building Components". *Special issue on Outdoor testing, analysis and modelling of building components*. *Building and Environment*. 43(2), pp. 152-162.

J. Matí-Herrero y M.R. Heras-Celemín. 2007. Dynamic physical model for a solar chimney. *Solar Energy*. 81(5), pp. 614-622.

M.J. Jiménez, M.R. Heras. 2005. Application of multi-output ARX models to estimate the U and g values of building components from outdoors testing. *Solar Energy*. 79(3), pp. 302-310.





# LLEIDA OUTDOOR TEST CELL (LOT) FOR DOUBLE-SKIN SYSTEMS



## GENERAL DESCRIPTION

### Main objective of the test facility

The Lleida Outdoor Test cell (LOT) [1,2] is a full-scale test facility for the comprehensive study of the energy performance of ventilated double skin facades in outdoor conditions. High quality data sets from the tests may be used for evaluation and modeling purposes.

The installation allows for the analysis of the effect of the air gap width, air flow regimes and materials of the façade. It is also prepared for the detailed analysis of double skin integrated PV systems and their with HVAC systems.

The façade may operate under natural and forced ventilation and the effect over the building is measured in a well-controlled test cell.

### organisations:



Building Energy and Environment Group (Beegroup).  
International Center for Numerical Methods in Engineering (CIMNE)  
08034 Barcelona, Spain  
[www.cimne.com/beegroup](http://www.cimne.com/beegroup)



Applied Solar Energy Group-  
University of Lleida.  
25001. Lleida , Spain  
[www.apse.udl.cat](http://www.apse.udl.cat)

### Contact person:

Jordi Cipriano  
Pere Cabrera s/n  
25001 Lleida  
SPAIN  
tel: +34-973003574  
[cipriano@cimne.upc.edu](mailto:cipriano@cimne.upc.edu)

## Overall lay-out



The LOT test facility (see Figure 1) is composed by a variable width double-skin BIPV façade and an adjacent test room. The external dimensions of the test facility are (3.5 x 5.5 x 3.6) m. To avoid uncertainties due to the effect of the solar radiation, the LOT has been covered by a white plastic sheet.

The double-skin façade air gap width ranges from 10 to 80 cm and the movable façade system is guaranteed by 4 engine actuators (see Figure 1 and Figure 2).

The LOT facility is composed of a well-insulated cell: the test room walls are insulated with 12 cm thick rock wool boards, the floor is insulated with 10 cm thick extruded polyethylene and the roof is insulated with 15 cm thick rock wool boards (see Figure 3).



Details of the ventilated air gap



Figure 1. LOT test facility. Front and rear view.



Figure 2. LOT test facility protected from solar radiation effects

## PART 1: Facilities for outdoor testing of building components

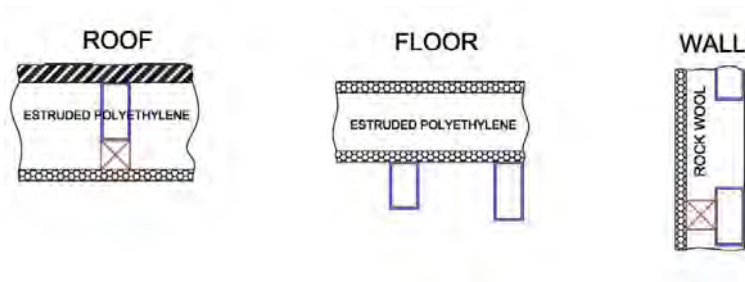

Figure 3. Construction details of the LOT facility. Cross-section of the floor (left); Cross-section of the roof (right)

The HVAC system is composed of a reversible electric heat pump. A special air distribution system has been designed to avoid temperature stratifications within the control volume (see Figure 4). This HVAC systems allows for a detailed control of the set-point temperature within the test room. The energy consumption and the thermal energy delivered to the test room is measured each time step with the data logger.



Figure 4. HVAC system. Air distribution system

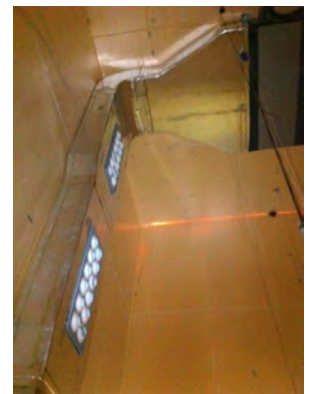

Figure 6. View of the heat flux tiles



Figure 5. Mounting the inner solar protection

A black curtain (see Figure 5) is placed inside the test room at 40 cm distance from the south façade to be tested: the transmitted solar radiation heats up the high absorptive curtain which transfers this energy to the test room by means of convection and long wave thermal radiation. This approach avoids a

disturbance of the direct solar radiation over the wall temperature measurements.

To evaluate the energy balance of the test room, homemade flux tiles are installed. EPS panels are placed at the internal side of the walls, the floor and the roof with the aim of covering the overall internal surface of the test room. Only the south façade, where the test element is placed, is kept without these tiles. Two type T thermocouples are placed at the same height in both sides of the EPS panels. The thermocouples are protected from the solar radiation with a reflective adhesive tape. An overall number of 72 pairs of thermocouples are installed spread over the walls, floor and roof of the test room. Since the thermal conductivity of the EPS panels has been previously measured in laboratory, the heat flux which crosses each panel is obtained from the temperature difference measurements multiplied by the conductivity (following Fourier's law). The effect of the thermal inertia of the EPS is calculated each times step when non-stationary tests are performed.

The air temperature inside the test room is measured with type T thermocouples at five different positions and considering 5 different heights (0.5m, 1.5m, 2.5m, 3.5m, 4.5m). These sensors allow for the control of the ventilation system to avoid stratification (see Figure 6). The thermocouples are shielded from the solar radiation with copper cylinders and reflective coating. Micro fans are also installed at the bottom of the cylinders to avoid overheating of the temperature sensors.



Figure 7. Position of thermocouples to measure the air

The surface temperature of the double-skin component is also measured at 3 different heights 2 positions. The ventilated air gap is also measured at 3 different heights (1m, 3m, 5m) and two horizontal positions (see Figure 7).

The double skin façade can work under natural or forced regime. The air flow is collected at the top of the façade with a conic hood. The air flow rate is measured with a combination of differential pressure gauges (placed at the inlet and outlet of the façade) and omnidirectional anemometers (see Figure 8).



Figure 8. Differential pressure

## Outside boundary conditions

The outside conditions are measured with a local weather station placed at 10 m height (temperature, relative humidity, horizontal solar radiation, wind direction and speed). This weather station also measures direct solar radiation with a pyrelimeter ( see figure 9). In addition, ambient temperature, wind direction and speed are measured next to the LOT, at 2 m height.

## DATA ANALYSIS

The present work reflects the necessity of performance indicators for multipurpose façade and BIPV systems under real operating conditions which differs from both STC and NOCT standards [3]. The experimental data from the LOT facility covers the general lack of experimental data from full-scale buildings with double-skin systems under controlled outdoor conditions , avoiding the effect of the occupancy.

The experimental data are analyzed with software like CTSM, TRNSYS and R Statistics and the thermal characteristics of the component are evaluated.

## Link to other devices

The energy characterization of ventilated BIPV components is also carried out in the Test Reference Environment of Lleida (TRE-L) [3-6].



Figure 9. Weather station



Front and rear views of the Test Reference Environment of Lleida (TRE-L) at the LOTCE center [3].

## RELEVANT LITERATURE

### Literature on previous measuring campaigns and data analysis:

[1] Lodi C, Cipriano J, Olivera J, Chemisana D, **Lleida Outdoor Test center for BIPV systems**, EnergyForum 2011 on Solar Building Skins, 2011, Bressanone (Italy).

[2] Lodi C, Cipriano J, **Lleida Outdoor Test center**, DYNASTEE Workshop on “Dynamic Methods for Building Energy Assessment”, 2010, Bruxelles (Belgium).

[3] Bloem JJ, Lodi C, Cipriano J, Chemisana D, **An outdoor Test Reference Environment for double skin applications of Building Integrated Photovoltaic Systems**, Energy and Buildings 50 (2012) 63-73, doi: 10.1016/j.enbuild.2012.03.023

[4] Lodi C, Bacher P, Cipriano J, Madsen H, **Modelling the heat dynamics of a monitored Test Reference Environment for Building Integrated Photovoltaic systems using stochastic differential equations**, Energy and Buildings 50 (2012) 273-281, doi: 10.1016 /j.enbuild.2012.03.046

[5] Lodi C, Bacher P, Cipriano J, Madsen H, **Modelling the heat dynamics of a monitored Test Reference Environment for BIPV systems through deterministic and stochastic approaches**, DYNASTEE Workshop on “Whole Building Testing Evaluation and Modelling for Energy Assessment”, 2011, Lyngby (Denmark).

[6] Lodi C, Cipriano J, Bloem JJ, Chemisana D, **Design and monitoring of an improved Test Reference Environment for the evaluation of BIPV systems**, EU PVSEC 25th European Solar Photovoltaic conference, 2010, Valencia (Spain).

# JACQUES GEELEN LABORATORY - ULG ARLON CAMPUS



## GENERAL DESCRIPTION

### Main objective of the test facility

The aim of this facility is to provide a testing platform for building energy systems combining building demand, heating and cooling emitters, water-based and air-based distribution systems, storage systems and heat and cool production systems. The latter are based upon the use of low exergy systems using renewable sources (solar system and reversible heat pumps).

The facility was built between 2000 and 2002 and includes a climatic chamber in which a well defined climate can be controlled (in terms of temperature and humidity). The facility was first built to host experimentations dealing with the production of fog in an artificial climate and was designed at that time to evolve to the testing of energy systems.

### Institute/organisation:



### Contact person:

Dr Philippe ANDRE  
ULg - Arlon Campus  
185, Avenue de Longwy  
B-6700 ARLON  
32-63-23 08 58  
[p.andre@ulg.ac.be](mailto:p.andre@ulg.ac.be)

### Exact location:

Arlon, Belgium  
49° 40N, 5° 49° E

## Overall lay-out

The facility includes 4 zones: the climate chamber which is surrounded by a buffer space (1 m width) where a given temperature profile can be imposed; the offices zone where the measurement interfaces are located and the technical area where all the production, storage and distribution equipment is located.



*Small-scale mock-up of the test facility*



View of the facility during construction

The dimensions of the climatic chamber are 4m x 3m x 2.5m. The buffer space is 1m wide. The climatic chamber can be the object of the testing (by submitting the energy system to controllable and reproducible heating and cooling loads) or can host the tested device (floor heating, air diffusion system, new concept of wall,...). The whole testing facility is made of timber frame wood material with a high level of thermal insulation.

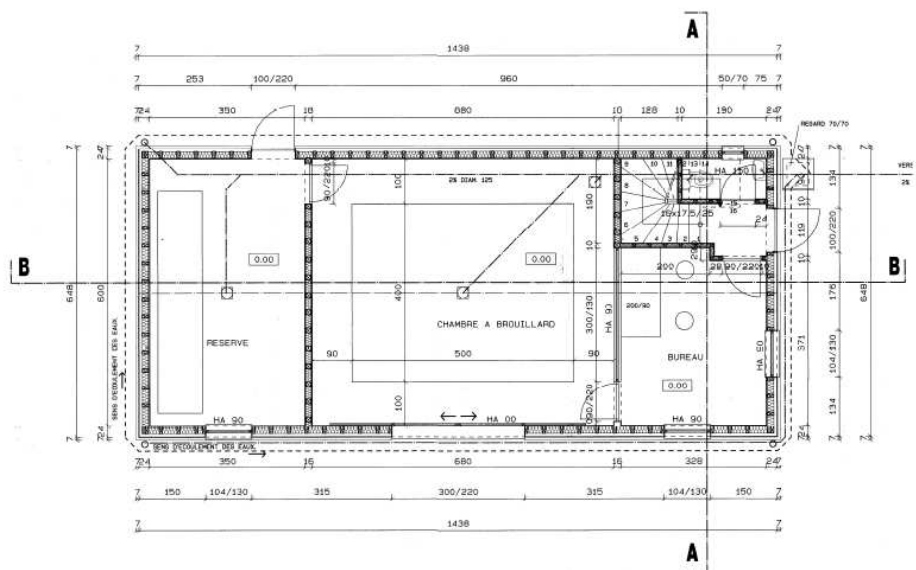

*Floor plan view of the building*



## Inside boundary conditions

The climate chamber can be submitted to a wide range of temperatures (air or resultant): between 10 and 40°C. In the buffer space a similar temperature range can be imposed. The climatic room can be submitted to heating or cooling loads using either electrical resistances or a reversible air conditioner. Latent loads can also be defined using water spraying or vapour production. Inside conditions can also be imposed by the HVAC system of the building using different emitters: floor radiating systems in all rooms, radiating ceiling in the climate chamber, air supply in the climate chamber and in the buffer space.



Inside view of the climate chamber

## Outside boundary conditions

There are two possibilities to define the outside conditions: either the natural climate as it is when the whole building is used as the test object or the buffer space in which an artificial climate can be created when the climate chamber is the object of the testing. This artificial climate can be defined in terms of air temperature in a range between 5°C and 40°C. Hourly or sub-hourly sequences can be imposed. In the future, it is planned to add humidity and solar radiation as variables to control in the buffer space.

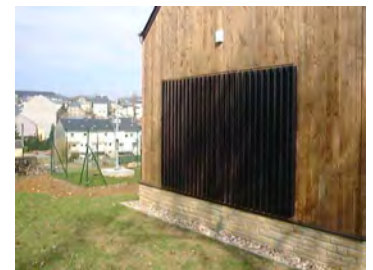

View of the heat pump external units (static - above; dynamic - below)

## Special limitations / possibilities

The cross section of the climate chamber is 4 x 2.5m in one direction and 5 x 2.5m in the other direction. This limits the size of the building elements that can be tested in the chamber. Additionally, access to the chamber limits further the dimensions of the tested elements.

The other important limitation is concerning the temperature range. The lower value is imposed by non-freezing conditions as the both the radiating floor and the radiating ceiling are fed with pure water. Colder temperatures could be afforded by replacing pure water with glycol water in the whole heating circuit.



## DATA ANALYSIS

### Typical equipment within test wall

The building is equipped with more than 150 sensors located in both the building spaces and the HVAC systems. In the spaces, the following variables are measured: air temperature, resultant temperature, wet bulb temperature, air velocity. In the HVAC system, the following variables are measured: water temperature, air temperature, air humidity, pressure, flow rates, electricity power and consumption.



View of the data acquisition system interface

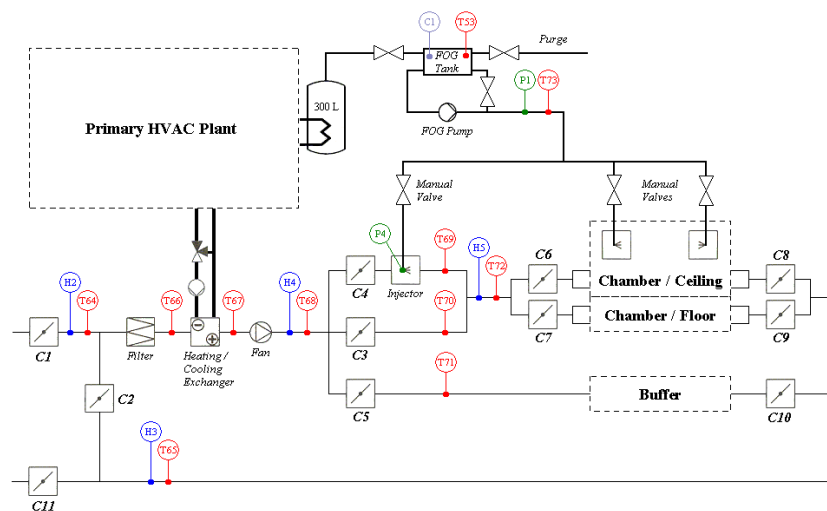
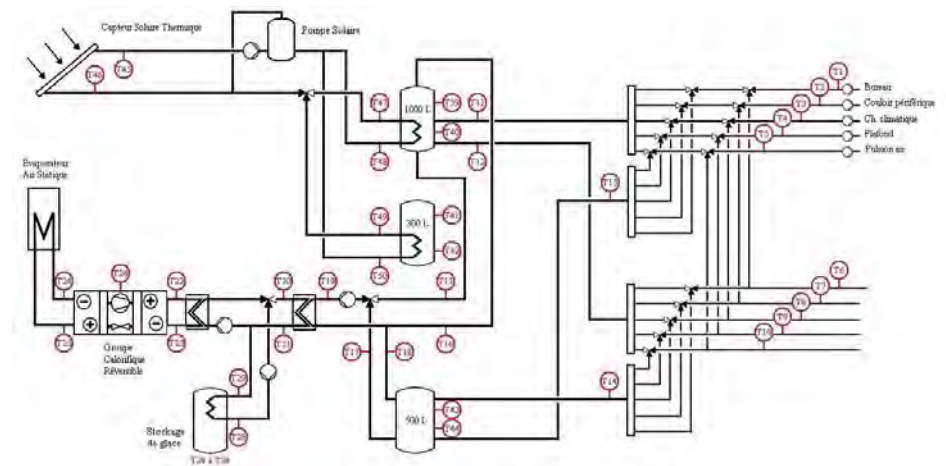

Overview of sensors installed on the Air-Handling Unit

## Accuracy and logging resolution

Temperature measurements are performed using thermistances. Humidity measurements in the climate room use wet-bulb thermometers. Resultant temperatures are measured using globe thermometers. Hot-wire anemometers are also available for air-speed measurements. Data are acquired every second and can be achieved with a time resolution down to 10 seconds.

## Analysis of the data

Data are analysed in function of the objective of the research project. In research focusing on the HVAC system, energy balances are calculated from measurements; in studies focusing on the climate chamber, treatment is applied on the temperature, humidity,... measurements. Global measurements carried out on the building included: infrared thermography, blower door test.

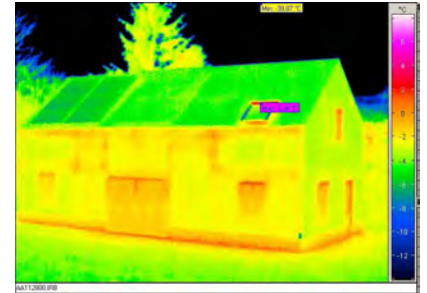

Infrared analysis of the building

## EXAMPLES OF PREVIOUS STUDIES

Recent projects using the test infrastructure are:

- air diffusion: development of a compact ventilation system with heat recovery
- solar cooling: analysis of the performance of a solar cooling machine in different operating conditions
- floor heating: development of low inertia (low thickness) floor heating concept
- solar chemical storage: development of a concept of solar chemical storage in different operating conditions



Blower-door test conducted on the building

## MAINTENANCE / COLLABORATION

### Personnel involved

The infrastructure is operated by the research staff with each researcher being involved in the experiment definition, test conduction and data treatment. Most of the technical tasks are performed by the technical staff attached to the research team.

### International collaboration

The large scale test facility was built in the context of a European project and took profit of European funding. However, all researches conducted in the



Air diffusion visualisation using fumes

testing facility were at this point funded by regional funds and consequently did not involve international collaboration.

### Link to other devices

The facility is running for the moment as a stand-alone infrastructure. One mid-term objective is presently to establish a connection with the TRNSYS simulation software in order to be able to run “emulation” based tests where a physical component not present or not yet available in the physical facility is replaced by a mathematical model representing the behaviour of this component.

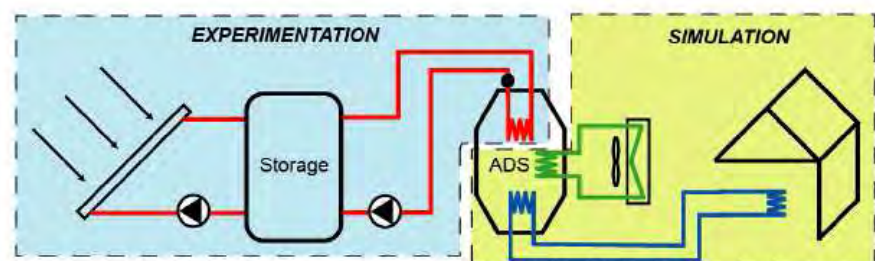

Connection of experimentation and numerical simulation

## RELEVANT LITERATURE

### General literature about the test facility:

Construction of the test facility is described in detail in:

ANDRE, Ph. Editor WP7 report: Construction of a prototype environmental chamber. Report of the FOG project (contract G6RD-CT2000-00211), May 2003.

### Literature on previous measuring campaigns:

THOMAS, S. ; ANDRE, Ph. Numerical simulation and performance assessment of an absorption solar air-conditioning system coupled with an office building. Proceeding System Simulation in Buildings, Liège, December 2010

THOMAS, S. ; ANDRE, Ph.; HENNAUT, S. Combination of experimental and simulated small scale solar air-conditioning system. Proceedings EuroSun 2010 Conference, Graz, October 2010

ANDRE, Ph.; KELLY, N.; BOREUX, J-J. ; LACÔTE, P. ; ADAM, Ch. Different approaches for the simulation of an experimental building hosting a climate chamber devoted to artificial fog production. Proceedings Building Simulation 2003 (BS'03), Eindhoven, August 11-14, 2003.

## LECTURE ROOMS AT KAHO

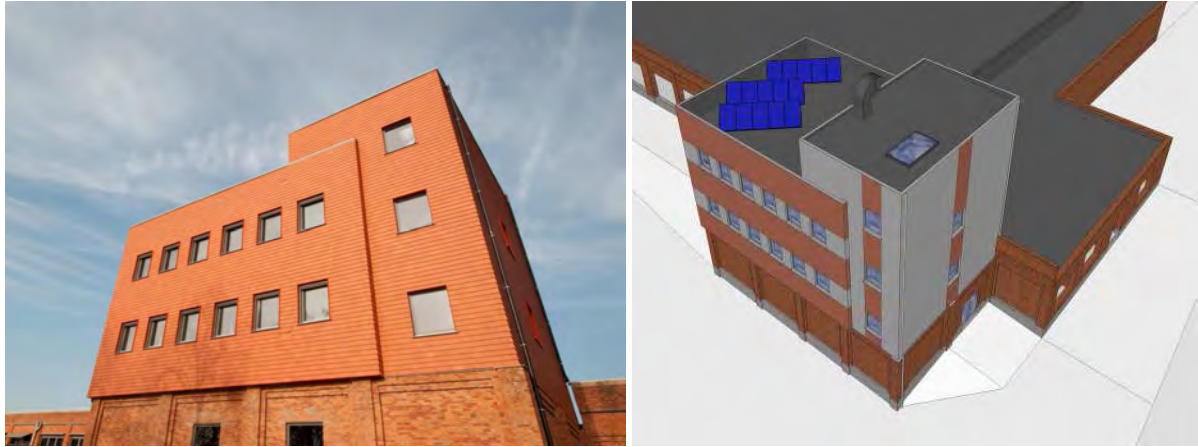

## GENERAL DESCRIPTION

### Main objective of the test facility

The building has three combined functions:

- **Part of the campus facilities** of the Technology-campus Gent, KAHO Sint-Lieven, KU Leuven, with two lecture rooms for 80 students each. This new facility has a much higher comfort and performance level than the other lecture-rooms of the campus and can serve as “good example” for the students of the Civil Engineering department. The students can experience the difference in indoor air quality, thermal comfort and monitored energy performance between this new facility and the existing, older campus facilities.

Institute/organisation:



KAHO-Sint-Lieven / KU Leuven

Contact person:

Ralf Klein  
ralf.klein@bwk.kuleuven.be

Exact location:

Gent, Belgium  
51.06005 (N), 3.70927 (E)  
(decimal Lat./Long.)

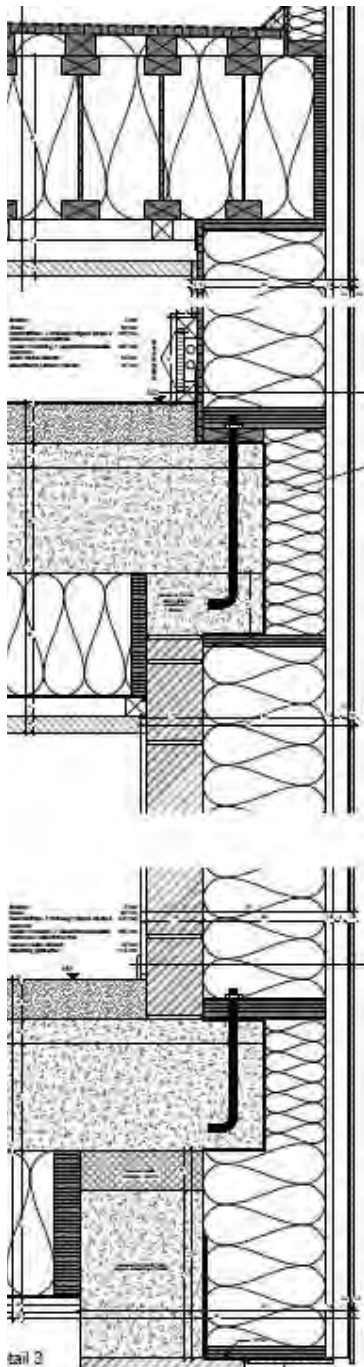

- **Showcase** for innovative HVAC, BMS and monitoring technology for engineering students, complemented by a “virtual building” (BIM) and the use of LCA for the choice of materials with a low environmental impact and a limited carbon footprint. It will be complemented with an exposition space, showing the used construction materials, and a Lab with different elements of the BMS and monitoring-system, that can be used by students for experiments and thesis projects, on the ground floor.
- **Test facility** with an integrated, open and modular system for monitoring and control of the building and with a free choice between “real use” and “test conditions”. The test facility will be gradually extended and refined, depending on the different research projects and obtained financial support.

### Overall lay-out

The building was designed according to the Passive-House standard, with two lecture rooms for 80 students each. The geometry of the building was kept “simple” to facilitate the creation of different simulation models and to limit the complexity of the monitoring system. On the other hand the building was equipped with a high performance AHU (heating and cooling), a wood pellet boiler, motor-controlled exterior sun-shading and windows and high performance lighting with daylight control (DALI), to be able to test the interaction of these different technologies and to measure their impact on comfort and energy performance of the building.

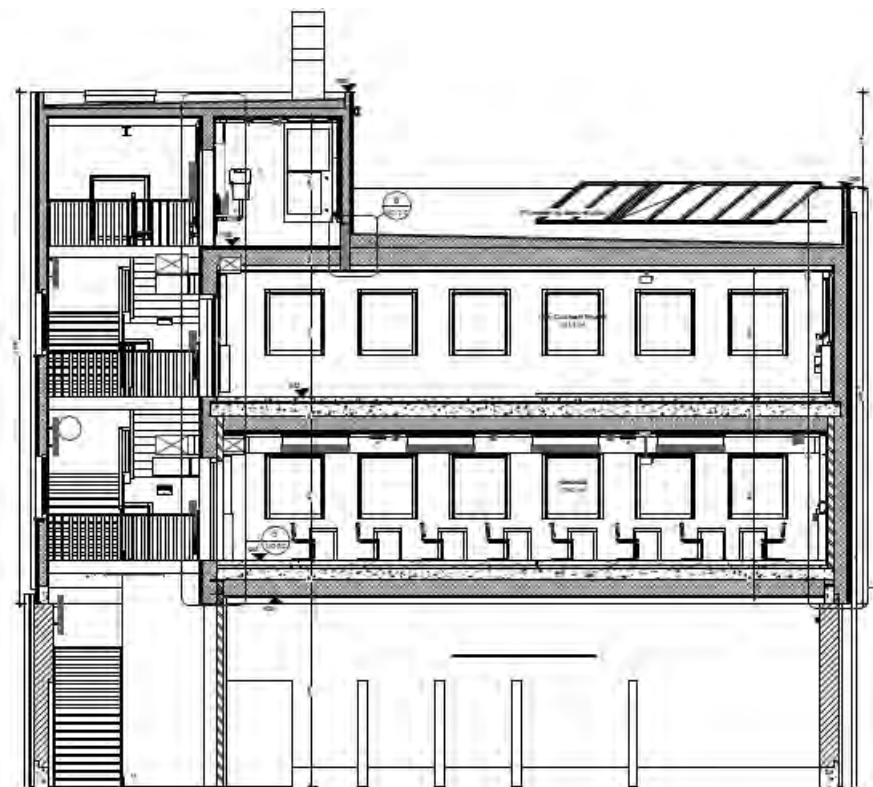

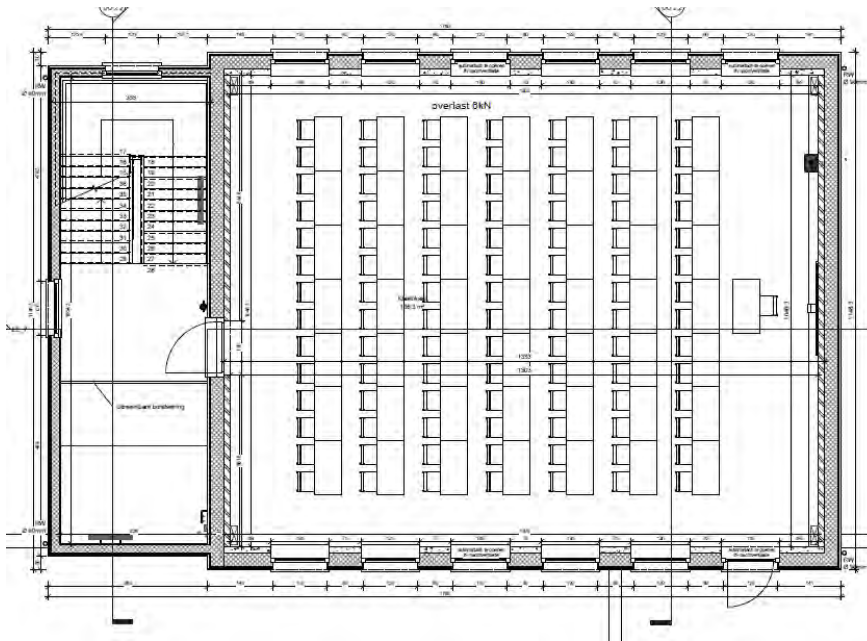

The new facility consists of two levels, constructed on top of an existing building (ground-floor only). Air-tightness of the two classrooms was tested and fulfils the requirements of the Passive House standard. Access to the classrooms as well as to the technical room and further to the flat roof is provided by a staircase, which forms a thermally separated volume. This results in a layout with two identical, box-shaped volumes with different thermal mass (one with a timber-frame structure, one with brick-walls). These two volumes are separated with thermal insulation in-between the two and towards the staircase and the technical room.

### Inside boundary conditions

In normal operation, indoor conditions are kept in a comfortable range (about 20°C in winter and a maximum of 25°C in summer) with the AHU (heating and cooling) and if desired with night-ventilation (automatically operated windows with mechanical extraction (if needed)). The exact operating schedule has still to be determined and could be adapted to the needs of research projects.

For test purposes dynamic inside BC's can be imposed. Only one of the two rooms has to be available for teaching purposes, the choice which of the two is in "normal use" is up to the research team. The other one might be occupied for longer periods for tests without users, or use can be switched between the two for comparison purposes.

### Outside boundary conditions

Natural climate, monitored with weather-station on top of the building: global irradiation, temperature, humidity, wind speed and direction, precipitations.

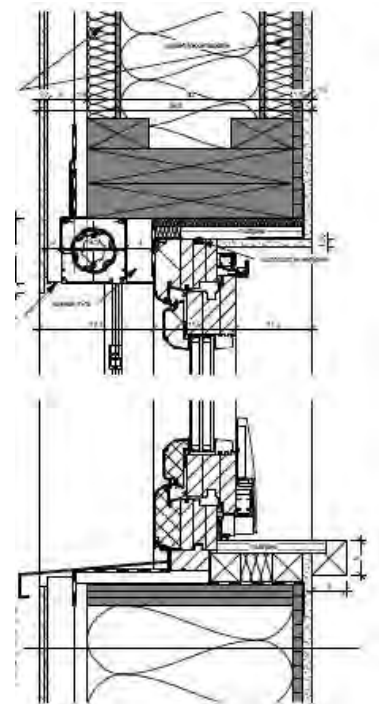

## Special limitations / possibilities

The sensors and all the equipment of the building (AHU, shading, windows, lighting, ...) is connected to an open, modular Building Management System (BMS). The system consists of two industrial PCs and distributed bus couplers with I/O modules. The bus couplers are connected through Ethernet-cable to the IPC using the EtherCAT-protocol for efficient and fast data transfer (see also [www.beckhoff.com](http://www.beckhoff.com)). A large choice of I/O-modules (EtherCAT terminals) is available and can be stacked on to the bus-couplers. This provides a very flexible system for the direct connection of sensors and actuators, that can easily be modified or extended, depending on the needs of different research projects.

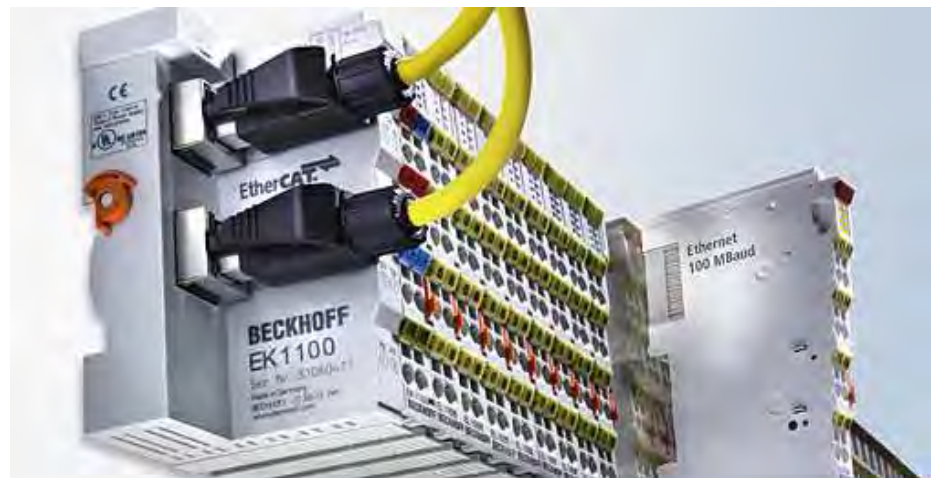
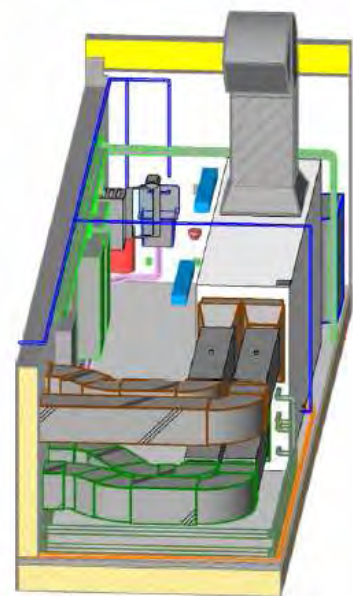
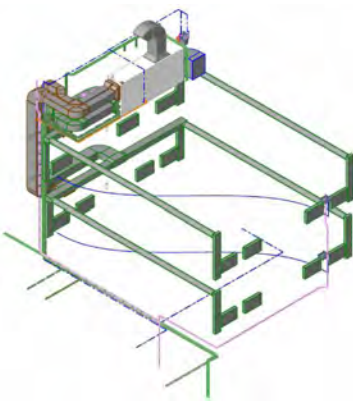
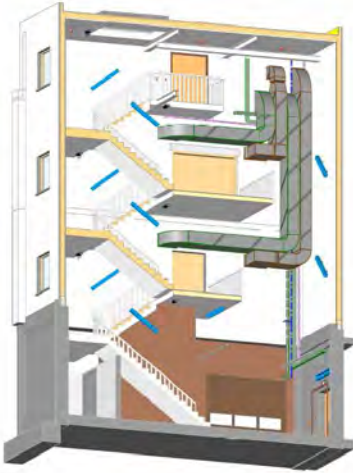

The system is controlled from one or several Soft-PLCs (Beckhoff TwinCAT3 running on one of the IPCs).

A second IPC can interact with the BMS and provide for example input from real-time simulation, weather prediction or data-analysis for predictive control or fault-detection algorithms. On this second IPC a database-server is running, that stores the information from all data-points connected to the I/O-modules of the first IPC.

Through dedicated EtherCAT terminals and software libraries connections can be made using open standard fieldbus protocols.

In this test facility, BACNet will be used for the connection to the AHU, giving access to most of the internal sensors and actuators of the unit.

Lighting will be controlled through DALI, solar shading through KNX. The calorimeters between wood-pellet boiler and heat exchanger of the AHU will be connected through M-bus.

This will allow gaining experience with the most commonly used open standard fieldbus systems, while keeping all the data in one system and hiding the complexity of different hardware and communication protocols. The user



can get data in real-time from an internal temperature sensor in the AHU in the same way as from another sensor located in a room or outside the building.

A full as-Built BIM (AutoDesk REVIT and IFC models) will be available and will serve as context for simulated and measured data.

## DATA ANALYSIS

### Typical equipment within test building

As stated earlier, sensors can be added as needed to the system. For the time being a monitoring system was designed, that captures all relevant energy-flows and occupancy of the building.

Four Venturi's with differential pressure sensors are integrated in the duct-system, providing accurate data for the air-flow towards and from the two classrooms separately. Also temperature and humidity at different locations in the air-ducts is measured.

Calorimeters are installed between boiler and heat exchanger of AHU.

In the classrooms temperature, humidity and CO<sub>2</sub> is measured.

Electricity consumption is measured for each circuit (e.g. AHU, lighting classroom 1, plug loads classroom 2, ...). For lighting additional detail is available through DALI (e.g. dimming % per fixture).

## EXAMPLES OF PREVIOUS STUDIES

Since this is a new test facility, no further information is available yet. Research will be performed in close collaboration with Building Physics Lab, KU Leuven.



# ENERGYFLEXHOUSE®



## GENERAL DESCRIPTION

### Main objective of the test facility

EnergyFlexHouse® consists of two, two-storied, single-family houses with a total heated gross area of 216 m<sup>2</sup> each. The two buildings are in principle identical, but while the one building acts as a technical laboratory (EnergyFlexLab), the other is occupied by typical families who test the energy services (EnergyFlexFamily). Each family lives in EnergyFlexFamily for 3-5 months at a time. In principle, everything can be changed in the two buildings: the thermal envelope, heating system, ventilation system, renewable energy, etc. The buildings were put into operation during the autumn of 2009.

In EnergyFlexLab focus is on short-term tests where the interaction between installations, buildings and real weather conditions gives a unique possibility of testing components and systems under realistic conditions. In addition EnergyFlexFamily makes it possible to test user behaviour, influence and acceptance of and interaction with the components and systems - i.e. EnergyFlexFamily is a living lab.

Institute/organisation:



**DANISH  
TECHNOLOGICAL  
INSTITUTE**

Energy and Climate  
Danish Technological Institute  
Taastrup, Denmark

Contact person:

Mikael Grimmig  
Gregersensvej  
DK-2730 Taastrup  
DENMARK  
tel: +45 72 20 24 15  
mg@teknologisk.dk

Exact location:

Taastrup, Denmark  
55° 39'N, 12° 16'E

## Overall lay-out

EnergyFlexHouse was built to resemble an attractive, Danish, detached, single-family house, designed so most people would get the feeling: “I could live in this building”.

The houses are built so they are better than the Low E class 1 defined in the former Danish Building Code from 2008, which is more or less identical to Low E class 2015 in the new Danish Building Code from 2010. The annual energy demand for space heating, ventilation, DHW and building-related electricity (not including energy for the household) amounts to less than 30 kWh/m<sup>2</sup>. With the pv production, EnergyFlexFamily is energy neutral over the year including the demand for electricity of the household and an electric vehicle. The EnergyFlexFamily is a prosumer: a traditional consumer, an energy producer and energy storage when it is needed from the grid.

The houses are constructed with a core insulated wooden frame structure as shown in figure 1 and 2.

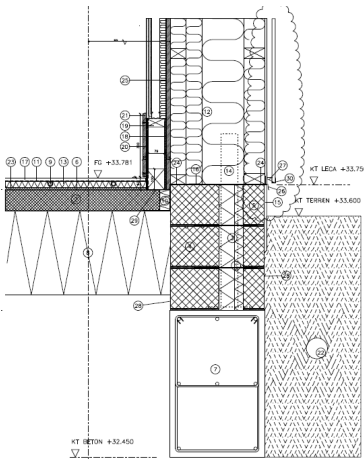

The foundation of EnergyFlexHouse.

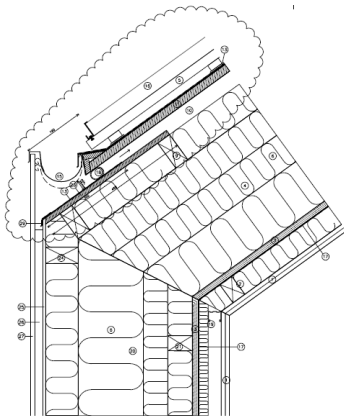

The eaves of EnergyFlexHouse.

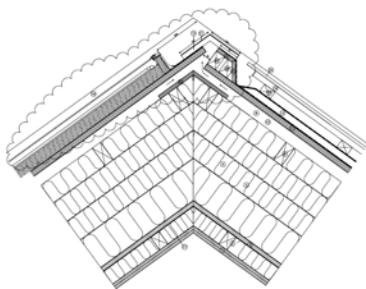

The ridge of EnergyFlexHouse.



Figure1. The load-bearing wooden skeleton of EnergyFlexHouse.

The insulation of the walls and roof is divided into several layers which can be stripped off to resemble the insulation level at different periods. The labels in figure 2 are:

- red arrow: the demand of the Danish Building code from 1977
- green arrow: the demand of the Danish Building code from 1995
- blue arrow: thickness in order to reach the Low E class 1 in the Danish Building code from 2008

By adjusting the thickness of the insulation and replacing the Low E windows, it is also possible to test energy saving solutions for renovation purposes.

## PART 2: Facilities for energy use analysis at whole building level

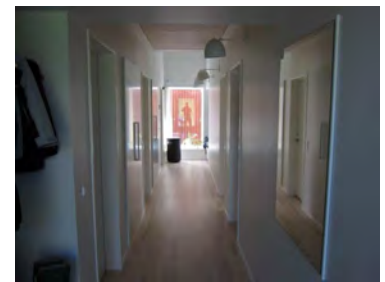
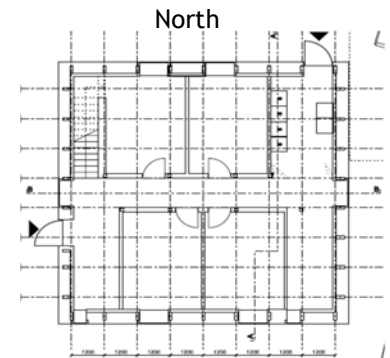
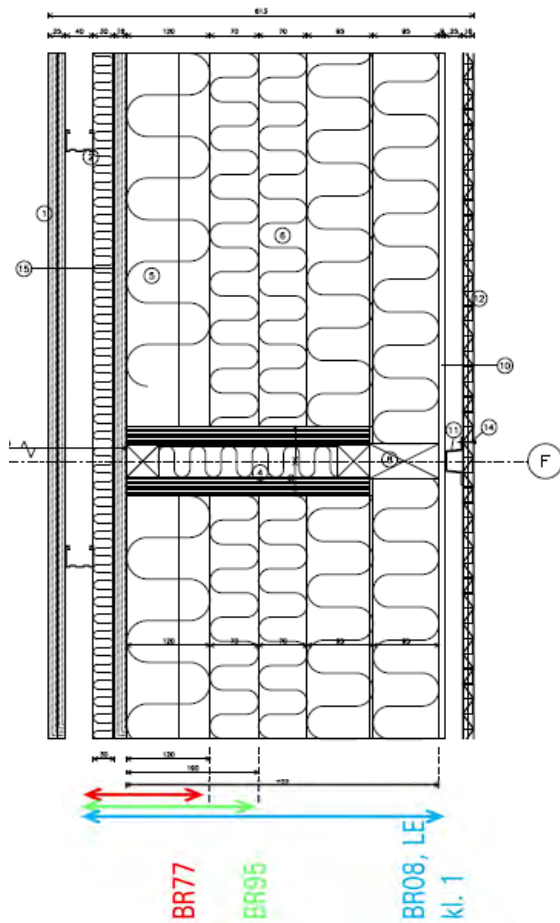

The floor plan and picture of the ground floor of EnergyFlexHouse.

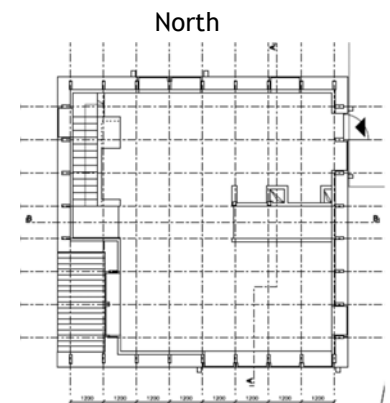

The floor plan and picture of the 1<sup>st</sup> floor of EnergyFlexHouse.

Figure 2. Horizontal cross section of an EnergyFlexHouse wall.

The U-values of the original design of EnergyFlexHouse are:

External walls:	0.08 W/m <sup>2</sup> K
Roof:	0.09 W/m <sup>2</sup> K
Ground floor slab:	0.105 W/m <sup>2</sup> K
Windows in external walls:	0.73-0.9 W/m <sup>2</sup> K
Skylights:	1.4 W/m <sup>2</sup> K

The layout of the two houses is similar to the layout of many Danish single-family houses (although reversed concerning the use of the two floors):

- Ground floor: 4 rooms and 2 bathrooms
- 1<sup>st</sup> floor: combined kitchen and living room

At the ground floor of EnergyFlexLab the floor plan allows for side-by-side testing: two rooms facing south are identical and two rooms facing north are identical.

Both buildings are equipped with pv and solar collectors as seen in figure 3.



District heating for EnergyFlexHouse.



Area with ground source heat exchangers for the ground coupled heat pumps in EnergyFlexHouse.



Sun screening of the windows facing south on EnergyFlexHouse.



Floor heating in the ground floor during construction of EnergyFlexHouse.



EnergyFlexLab:  
12,5 m<sup>2</sup> Solar collectors  
40 m<sup>2</sup> pv panels

EnergyFlexFamily:  
5 m<sup>2</sup> Solar collectors  
60 m<sup>2</sup> pv panels

Figure 3: The solar collectors and pv panels of the two EnergyFlexHouses. Approximately 20 m<sup>2</sup>pv is needed for the electric vehicle.

### Inside boundary conditions

Different possibilities are available for creating the desired indoor climate in EnergyFlexHouse:

- Heating: boilers - gas, oil, pellets, ..  
heat pumps: ground couples, air to water, air to air  
district heating  
solar heating
- Ventilation: mechanical: with passive heat exchanger and/or air to air  
heat recovery heat pump  
natural ventilation  
hybrid ventilation
- Solar radiation: sun screening
- Cooling: so far no cooling system has been installed but it may be later if required by tests
- Heat distribution system: floor heating, radiators (either by the window or at the back wall) or via the ventilation systems

The internal conditions in EnergyFlexLab may be adjusted in order to reach the conditions required by a test. In EnergyFlexHouse the conditions are the normal comfort conditions in a house, expected by the families who live there.

## PART 2: Facilities for energy use analysis at whole building level



Figure 4. The first family in EnergyFlexFamily.

### Outside boundary conditions

The outside conditions are the actual weather conditions on Zealand, Denmark where EnergyFlexHouse is situated.

In order to monitor the microclimate around the two houses, several sensors are applied:

- Weather station at 10 m: ambient temperature, wind speed, wind direction, rain, humidity, barometric pressure
- Solar radiation: global and diffuse horizontal total on south, west and east of the houses on the south facing roof of the houses
- Ambient temperature: at the south, west, east and north of the houses
- Long wave radiation: horizontal

### Special limitations / possibilities

The houses are designed to limit constraints as much as possible: meaning that everything in principle can be changed.

The limitations are the size and orientation of the houses and the specific conditions created by the Danish weather.

For envelope components, the size limit is determined by the distance between the wooden, load-bearing skeleton. That distance is 1.2 m.

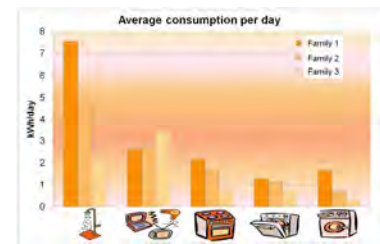

Mean daily energy demand of three different families distributed on different services.

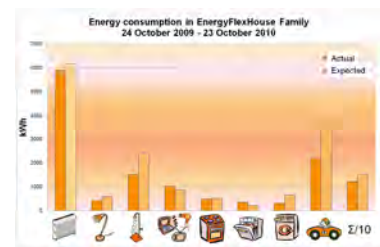

Energy demand distributed on services during the first year with three families in EnergyFlexFamily.

Combined global and diffuse radiation pyrgometer

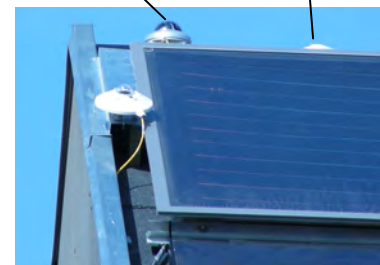

Pyranometers and pyrgometer at the roof of EnergyFlexLab.



Pyranometer and temperature sensor at the south wall of EnergyFlexLab.

## DATA ANALYSIS

### Data acquisition system

The basic layout of the data acquisition system is shown in figure 5 and 6. Figure 5 shows the data acquisition system in EnergyFlexLab, while figure 6 shows the data administration. The data acquisition system in EnergyFlexFamily is similar to figure 5, but in order not to disturb the families the room sensors are wireless. In addition the electricity demand on all plugs, ceiling points and of the white goods in EnergyFlexHouse is measured individually and the opening of doors and windows is logged.



Heat meters at EnergyFlexLab.

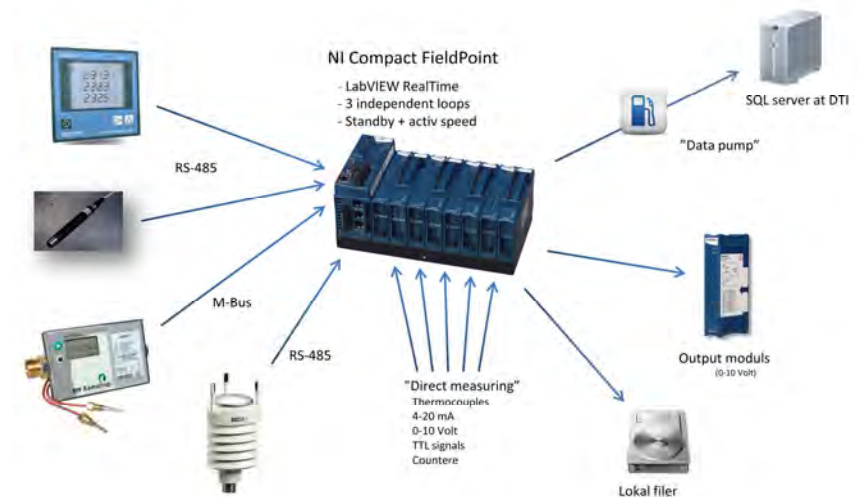
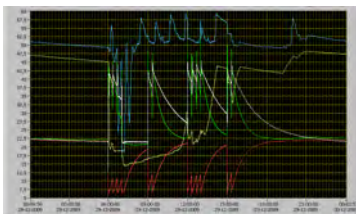

Figure 5. The data acquisition system in EnergyFlexLab.



Cold and hot water temperature and temperatures in the DHW tank.

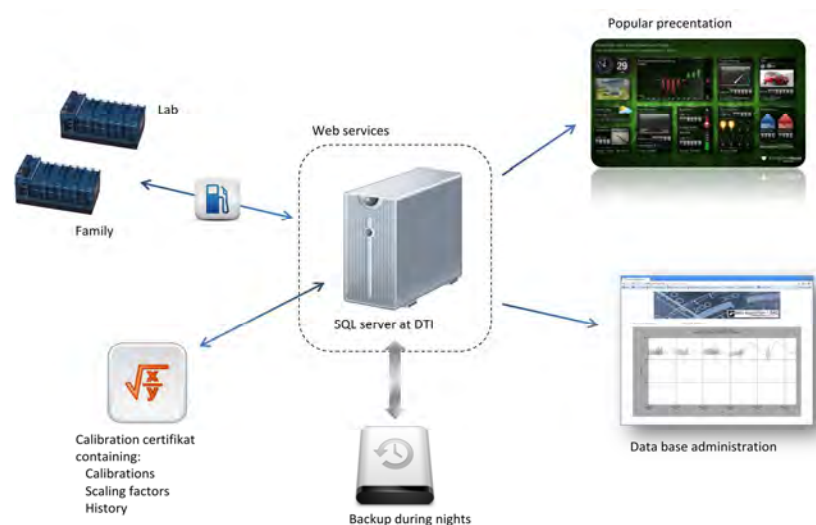

Figure 6. Data administration.



## PART 2: Facilities for energy use analysis at whole building level

At the beginning of 2011, up to 700 measuring points were included in the EnergyFlexHouse data acquisition system. The data acquisition system is scalable so new sensors may be added.

In addition to the weather sensors, the basic sensor set consists of:

- air temperature sensors
- surface temperature sensors
- temperature sensors embedded in the constructions
- temperature sensors in the installations
- air humidity sensors - both in rooms and ventilation systems
- CO<sub>2</sub> sensors - both in rooms and ventilation systems
- heat flux sensors
- air speed sensors - both in rooms and in ventilations systems
- lux sensors
- contacts on windows and doors
- heat flow meters
- electricity meters
- multi amperimeters



Air, globe and surface temperature sensors, humidity sensors, lux sensor and heat flux sensor in one side-by-side room in EnergyFlexLab.

### Accuracy and logging resolution

All sensors and meters have been calibrated and the documentation is available on file - as shown in the left bottom corner of figure 6.

### Analysis of the data

There is no standard procedure for analysis of the measured data from EnergyFlexHouse as many very different tests and experiments may be carried out. However, one standard analysis is carried out on data from EnergyFlexFamily: a rolling annual energy balance including a popular presentation as seen in figure 6 and 7.



Embedded temperature sensors in the floor of one of the side-by-side test rooms in EnergyFlexLab before concrete was poured in.



Figure 8. Popular presentation of the energy balance in EnergyFlexFamily.

Link to the popular presentation:  
[http://datalog.energyflexhouse.dk/pview/index\\_en.html](http://datalog.energyflexhouse.dk/pview/index_en.html)

## EXAMPLES OF PREVIOUS STUDIES

Several studies have been, are being conducted or are scheduled to be carried out in EnergyFlexHouse - e.g.:



Optimized control of e.g. solar screening in order to decrease overheating.



Electric vehicle used by the families in EnergyFlexFamily.

### EnergyFlexFamily:

- The possibility of obtaining energy neutrality on an annual basis is being investigated with real families living in the building
- The user acceptance of different energy efficient lighting systems
- Optimized control of the installations (heating, ventilation and solar screening) in order to optimize the indoor climate while minimizing the energy demand
- Utilization of the electricity demand of households as regulation power for the grid
- Development of a micro ground coupled heat pump for single family low energy houses
- Electric vehicles in combination with energy neutral homes

### EnergyFlexLab:

- Heating (both space heating and DHW) via low temperature district heating
- PCM (phase change materials) in the floor slab for increasing the thermal storage capacity of the constructions
- Low energy windows with less dew on the outside
- Energy efficient DHW installations
- Demand controlled ventilation. Natural ventilation during the summer
- Optimization of the forward temperature to floor heating in order to increase the COP of a heat pump
- Optimization of the combination of savings and renewable energy sources on site in order to reach energy neutrality

## MAINTENANCE / COLLABORATION

### Personnel involved

The buildings are operated and maintained by the employees of the Energy and Climate Division at Danish Technological Institute.

## International collaboration

No formal international collaboration has yet been established, but promising contact with e.g. UC Berkeley, Lawrence Berkeley National Lab, Stanford, ITRI (Taiwan) and Research Centre for Zero Emission Buildings, Norway, is ongoing.

Danish Technological Institute is looking for international collaboration and project opportunities utilizing EnergyFlexHouse as part of the Danish contribution.

## Link to other devices

The two EnergyFlexHouses are part of the overall test possibilities at Danish Technological Institute as illustrated in figure 8.



Test of building components in hot box.



Test of circulation pumps.



Test of heat pumps.



Test of pv systems.

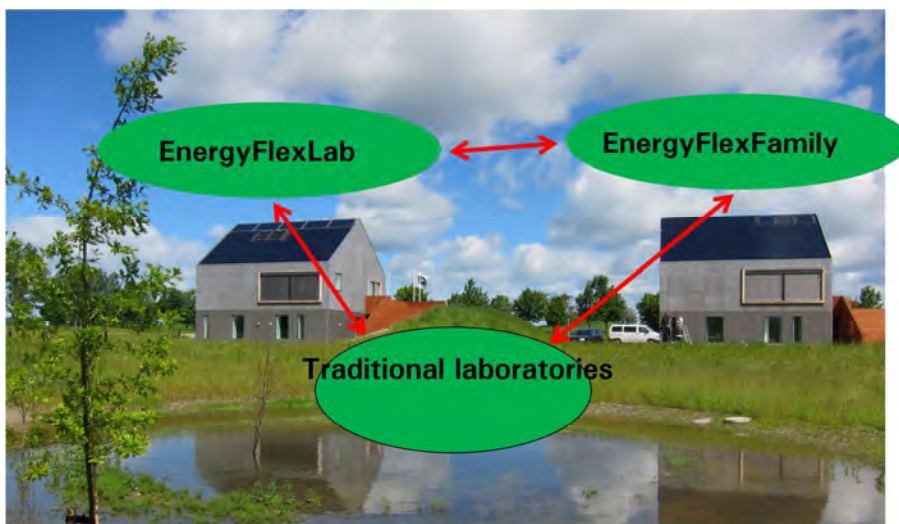

Figure 8. The interaction between the two EnergyFlexHouses and the traditional laboratories at Danish Technological Institute.

The traditional laboratories at Danish Technological Institute offer detailed component tests of: insulation materials, windows, ventilation systems, heat pumps, district heating units, circulation pumps, radiators, cooling systems, white goods, pv systems, consumer electronics, etc.

A logical test setup is:

- test and optimization of individual components in laboratory
- test of the interaction between components and building under real weather conditions: EnergyFlexLab
- test of the interaction between components, building and users under every-day conditions including user acceptance: EnergyFlexFamily (living lab)

## RELEVANT LITERATURE

### General literature about the test facility:

EnergyFlexHouse - Developing energy efficient technologies that meet global challenges:

[www.dti.dk/\\_root/media/36141\\_EFH%20publikation%20final%20low.pdf](http://www.dti.dk/_root/media/36141_EFH%20publikation%20final%20low.pdf)

[www.dti.dk/inspiration/25348](http://www.dti.dk/inspiration/25348)

Homepage of EnergyFlexHouse: <http://www.dti.dk/inspiration/25348>

### Literature on previous measuring campaigns:

Christensen, A.H. et al, 2012. Intelligent energy services in low-energy homes based on user-driven innovation (in Danish). Danish Technological Institute, Energy and Climate Division.

Tahersima, F., 2012. An Integrated Control System for Heating and Indoor Climate Applications. PhD thesis. Aalborg University.

Iqbal, A., 2014. Calculation methods for natural ventilation through centre pivot roof windows. PhD thesis. Danish Building Research Institute, Aalborg University.

Christiansen, C.H. et al, 2014. InnoBYG: Installation packages for single family houses - solar heating, heating and ventilation systems (in Danish). Danish Technological Institute, Energy and Climate Division.

Jensen, S.Ø., 2015. Natural ventilation in single family houses during the summer. Danish Technological Institute, Energy and Climate Division.



[www.dti.dk/\\_root/media/36141\\_EFH%20publikation%20final%20low.pdf](http://www.dti.dk/_root/media/36141_EFH%20publikation%20final%20low.pdf)

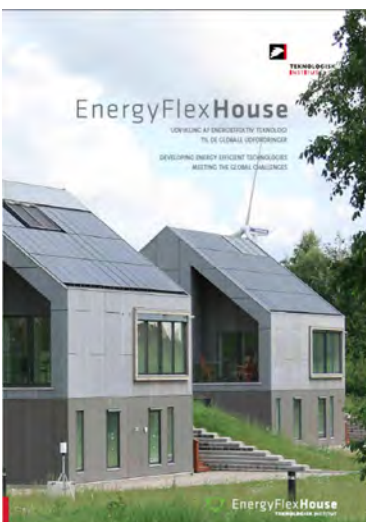

[www.dti.dk/inspiration/25348](http://www.dti.dk/inspiration/25348)

# INCAS PLATFORM - INES



Institute/organisation:



## GENERAL DESCRIPTION

### Main objective of the test facility

The Buildings Energy Laboratory is one of the R&D teams of the French National Institute for Solar Energy (INES). INES was created in 2006 close to Chambéry, in the French Alps, and is composed today of 400 people working on various research fields related to solar energy: from silicon purification to electricity management and storage, including energy efficiency in building and transport.

The INCAS platform is a full scale test facility developed since 2008 including 4 PASSYS test cells, 4 experimental houses and 10 PV-integration benches.

CEA - INES (National Institute for Solar Energy)  
Buildings Energy Laboratory

Contact person:

CEA LITEN - INES RDI  
Savoie Technolac - BP332  
50 av. du Lac Léman  
73377 Le Bourget du Lac Cedex  
FRANCE

Virginie RENZI  
Tel. : +33(0)479792215  
[virginie.renzi@cea.fr](mailto:virginie.renzi@cea.fr)

Jocelyn ANGER  
[jocelyn.anger@cea.fr](mailto:jocelyn.anger@cea.fr)

Patrice SCHNEUWLY  
[patrice.schneuwly@cea.fr](mailto:patrice.schneuwly@cea.fr)

Exact location:

Le Bourget du Lac, France  
45° 38' N, 5° 52' E  
Altitude 235m



PV-integration benches and solar concentrator.



The 2 South-oriented PASSYS cells.



Original PASSYS test facility composition.



Airtightness test (blower door) in experimental houses.

The 4 test cells came from Cadarache CEA research center (80's PASSYS European program); 2 of them were completely refurbished in order to suit the needs of our R&D program.

The first 2 experimental houses were constructed in 2009. There are currently 4 un-inhabited 95m<sup>2</sup> (HaS) houses, with the same internal geometry, same architecture, same level of insulation, and located under the same climate, hence in particular with the same solar inputs.



The four full-size experimental houses.

## Overall lay-out

### PASSYS test cells

The original composition of the test cells includes a very high insulation level. 5 out of their 6 façades are nearly fully adiabatic; therefore tests can be conducted on the 6<sup>th</sup> façade, which is removable and can be adapted for every project.

Two of the cells are fixed, with the test façade being oriented towards the South. The two other cells are installed on a rotational platform, allowing test under different orientations.

### Experimental houses

The 4 houses currently available are respectively made double wall of concrete blocks with insulation in between (house I-DM), cast concrete with exterior insulation (house I-BB), timber frame with wood insulation (house I-OB) and brick frame with an innovative insulating coating (house I-MA); insulation materials ranging from 20cm to 40cm in order to comply with the "Passivhaus" energy standard (less than 15 kWh/m<sup>2</sup> heating needs per year). First part of the research program was to carefully follow all the steps of the construction and the workmanship; the air tightness and thermal bridge issues have been carried out with high care so that to insure very high thermal performances.

## Inside boundary conditions

### PASSYS test cells

Two cells are equipped with brand new air handling units which allow a perfect control of air temperature, humidity and ventilation rate inside the test cells (15°C to 35°C, 6 to 14g/kg weight of water, until 400m<sup>3</sup>/h of fresh air). Furthermore this new installation is compliant with air quality experiments since it can integrate filtration devices.



*The new air handling unit.*

The two other cells are equipped with small heating and cooling split systems, allowing to control temperature (accuracy of + or - 5°C).

### Experimental houses

The houses are un-inhabited in order to control all the indoor boundary conditions. Human presence can be simulated (heat, humidity and CO<sub>2</sub>) according to usage schedules; thus allowing to represent occupants' behaviour in terms of energy and IEQ.

The houses are fitted with the latest energy systems. The ventilation is carried out by a heat recovery system, whereas heating and DHW can be connected to solar thermal panels. The roof is covered by a 5kWc PV system and local electricity storage can be performed.

Numerous systems in the houses can be distance-managed (roller shutters, windows opening, HVAC control, domestic hot water drawing). A multipurpose control system is being developed to master all the appliances and will allow to test a wide range of heating, cooling, ventilation or solar inputs control strategies.



The brand new rotational platform.



Human presence humidity simulators.



Human presence thermal simulators.



Automatism for windows opening/closing.



Details of the weather station.



Radiation sensors.



BiPV facade on PASSYS cells.

## Outside boundary conditions

A major interest of the INCAS platform is the ability to carry out the tests under real dynamic outdoor climate. The cells and the houses are located within an experimental area, where weather conditions are fully monitored, and where no undesired shading is observed.

Local weather conditions are measured through a weather station (temperature, humidity, wind speed and direction, rainfall) on a 12-meter high mast on the site. The solar resource is very well characterised by various radiation sensors, on a platform placed 15m above the ground: pyrheliometer on a suntracker, pyranometer, pyrgeometer, albedometer.

## Special limitations / possibilities

### PASSYS test cells

PASSYS cells allow to test facades or components up to 3.3m height and 3.6m width. It allows the test of passive solar components like windows or solar blinds as well as small active systems located on facade. Inner components or systems can also be tested.

### Experimental houses

The low energy houses provide an opportunity to study innovative active energy systems for buildings, such as new ventilation systems, solar thermal heating and DHW systems. Furthermore these houses allow to develop numerous strategies of global energy management and solar inputs control. Within certain limitations, passive solar envelope components can be tested too, like PCMs (phase change materials), innovative coatings, VOC absorbers and generally all kinds of innovative sensors. These houses are very performing from an energy consumption point of view with high building construction quality, thus they give a unique possibility to study the latest innovations in energy saving equipments.

## DATA ANALYSIS

### Typical equipment within test wall

### PASSYS test cells

The cells are equipped with extensive metrology, enabling to measure surface and air temperatures, humidity, and energy consumption (heating/cooling).



### Experimental houses

The houses are currently fitted with approximately 100 sensors each (wall temperatures, humidity, flow meters, energy consumption, solar irradiation on facade, etc.), with a continuous acquisition system (every minute, 24/7).

Measured temperatures are: external surface, inside the wall structure, internal surface and ambient air (protected from direct solar radiations). This allows to study at the same time the structure of the building (impact of inertia for example) and the indoor climate (comfort analysis). Measurement points are located at the middle of each surface and air temperature gradient is measured according to comfort standard height, at 0.1m, 1.1m and at 1.7m. Simultaneously a black globe temperature measurements and punctually radiant temperature are recorded. Humidity is measured in the wall structure and in one point at each level of the house.

An optical fiber has been set up all around the two high inertia houses, in order to measure inside wall temperatures in many points on every facade.

The laboratory is furthermore equipped with portable equipments focused on indoor environmental quality (IAQ, hygrothermal, visual and acoustic comforts). For indoor air quality different parameters can be studied: physical pollution (PM 2.5 and PM 10), chemical pollution (CO, CO<sub>2</sub>, VOCs and aldehyds and radon). A tacer gas equipment allows to quantify the air exchange rate and performance of ventilation systems.

The acquisition of data is performed by Agilent hardware, configured and managed with LabView-based applications. All data are stored in a server which has alarm functions, thus erroneous data are noticed immediately and reported to the user. This gives a very performing reactivity to our data survey system.

### Analysis of the data

A data analysis and data mining tool has been specially developed to study and fit the platform data, with advanced functions in plotting, statistical analysis, etc. Anyway the data analysis approach differs from one project to another. It depends on the characteristics of test components, and also on the focus of the study (energy, comfort).

Studies are generally carried out in two steps:

1 - In parallel with numerical studies. The thermal specifications of the PASSYS cells and the passive houses are well known, and the indoor environment can be controlled. Therefore, the tests can be conducted and the results compared with numerical studies (Dynamic Thermal Simulation and/or Computational Fluid Dynamics). In a general way, experimental tests are used to validate and develop numerical simulation tools.



PASSYS cells equipments.

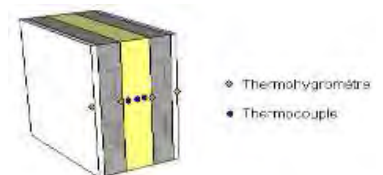

Wall embedded sensors.



IAQ equipments.



Optical fiber temperature continuous sensor.

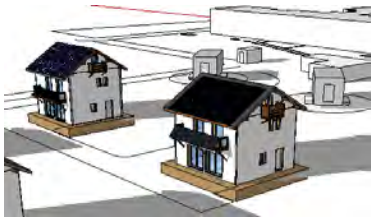

Models of the experimental houses.



2 PASSYS cells for comparison of coatings façade.



Model of the multifunctional inner wall - REPLIIC project.



IAQ monitoring - CETIEB project.

2 - Comparison between cells/houses. There are several cells/houses available at INES, with similar specifications. Therefore, tests can be conducted in parallel via two (or more) cells, exposed to the same orientation, equipped with the same systems and metrology, but showcasing various façades or internal materials. In PASSYS cells, the possibility to study the whole wall component exists. For these studies a special instrumentation is planned with measurements in the structure of the component. Hygrothermal characteristics are determined for the tested component and in parallel for a blind test component in order to quantify the gains and losses of the tested structure by comparison.

## EXAMPLES OF PREVIOUS STUDIES

### PASSYS test cells

- Study of an innovative automation and control system for solar shading.
- REPLIIC: experimental and numerical study of a multifunctional inner wall providing both insulation and heat emission in building energy renovation.
- Effinov'bois: renovation by additional wood frame façade.
- HYGROBAT: methodology for hygrothermal design of wood-based constructions and more generally construction materials based on vegetal fibres.

### Experimental houses

- VAICTEUR AIR<sup>2</sup>: development of HVAC systems for low energy building.
- Batimetre was a project dedicated to work on the monitoring methodology (which parameters have the highest influence on the thermal behaviour? which are the most important sensors?).
- HOMES was a 4-year long collaborative innovation program dedicated to Homes and buildings Optimized for Mastery of Energy and Services.
- CETIEB: European project developing a Cost-Effective Tools for Better Indoor Environment in Retrofitted Energy Efficient Buildings.
- IMVENTION: development of innovative mechanical ventilation with air blowing supply.

## MAINTENANCE / COLLABORATION

### Personnel involved

The entire INCAS platform is maintained by the LEB technical staff plus external personnel such as electricians or plumbers. Experiments are carried out by our laboratory team (sensors maintenance, acquisition and analysis). The tested components are generally constructed and installed by the manufacturer.

### International collaboration

Collaboration with international partners in the frame of European research programs and industrial cooperation.

### Link to other devices

The INCAS platform is part of INES facilities and especially research about smart grids and district/city energy management: electrical storage, solar mobility, building - transport energy compliance, thermal storage, district heating, ...

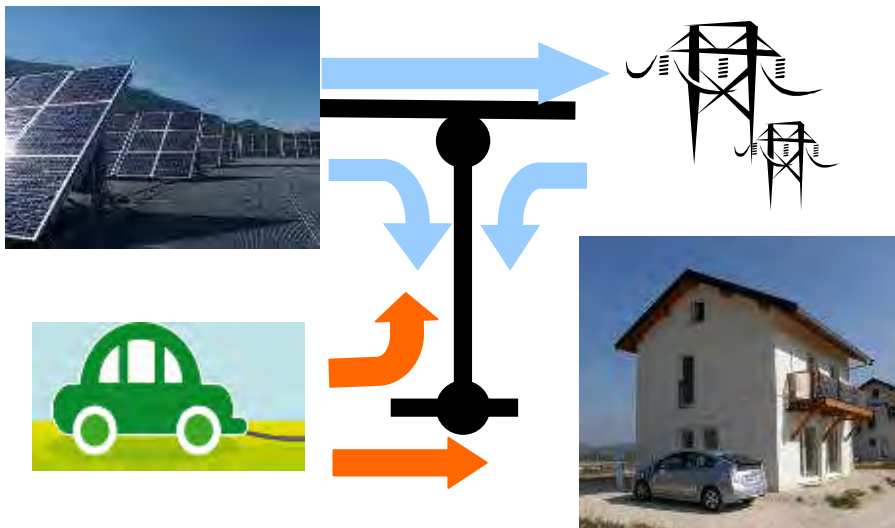

Innovative system of mechanical ventilation in the house attic.



[www.homesprogramme.com](http://www.homesprogramme.com)



Electrical cars and solar station.



# VERU - IBP HOLZKIRCHEN



## GENERAL DESCRIPTION

### Main objective of the test facility

- Fundamental studies regarding the overall energy efficiency of buildings
- Investigations aimed at establishing minimum requirements for proof procedures
- Research and development work concerning building units and building services components, aimed at reducing the primary energy demand or at optimising the integration into both façade concepts and technical equipment concepts under aspects of building physics

Institute/organisation:



Fraunhofer-Institut für Bauphysik  
Standort Holzkirchen  
Abteilung Energiesysteme,  
Deutschland

Contact person:

Dipl.-Ing. Herbert Sinnesbichler  
Fraunhoferstr. 10  
D-83626 Valley  
tel: +49 8024/643-241  
e-mail: herbert.sinnesbichler@  
ibp.fraunhofer.de

Exact location:

Holzkirchen, Deutschland  
47.88° N, 11.73° E



South-west view of the VERU test building.

- Determining the interaction of building units and technical equipment components in overall energy concepts or in building systems
- Validation and further development of computing models for simulating energetic and physical interrelations in buildings
- Preparing standard sets of data for the validation of software products in the fields of building simulation / building services equipment simulation, daylighting, flow simulation, comfortable indoor environment

## Overall lay-out

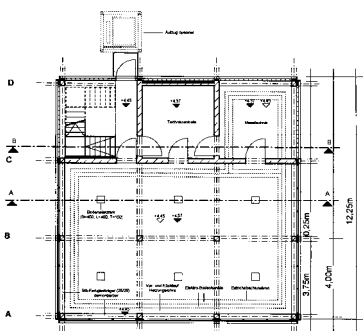

Floor plan showing the test rooms and the utility rooms.

The reinforced-concrete construction of the three-storey test building was raised in the unshaded part of the Holzkirchen outdoor test site on a surface area of 12 m x 12 m. On each floor there are six square test cells, which can be investigated both individually and in combination (for instance, if concepts for open-plan offices or conference halls are to be examined). The false ceilings being partially demountable, it is possible to investigate multi-storeyed spaces or halls. Moreover, removable roof slabs allow integrating transparent roof components, instead. Three test cells located in the northern area of each level serve as a stair well, host supply installations and the measurement instrumentation. Parts of the solid false ceilings contain systems for activating the concrete core.

## Inside boundary conditions

The VERU test facility has been provided with an extensive basic equipment for monitoring the relevant system parameters, like e.g. medium temperatures and mass flows inside the heating circuits and the cooling cycles, air flows, relative humidity und temperatures in the supply and extract air cycles, indoor air temperatures, indoor air humidity, surface temperatures and heat flows inside the test rooms and at the façade. The demand for electrical auxiliary energy for pumps and heating grids is documented by no stationary recordings, just like the time profile of the internal heat sources.

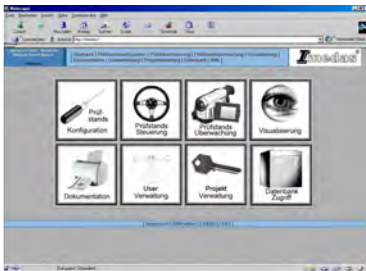

Exemplary presentation of the internet-based IMEDAS™ process visualisation system

The central control of the test facility is managed by a modular storage-programmable control system (SPS). Measurement data are collected by IMEDAS™ (a specialised data acquisition system that was also developed by IBP scientists) which also communicates with the central control unit, storing relevant process data and system states in the central data base. Furthermore, Imedas™ enables engineers to visualize processes that are currently occurring at measurement sites via the intranet and the internet. Settings and boundary parameters can be modified and controlled from any workplace, protected by passwords, thus allowing to display latest test-facility data at trade-show presentations, for potential clients and in one's own company.

## Outside boundary conditions

Climatic data recording is carried out by the central weather station at IBP Holzkirchen. This records the most important meteorological boundary conditions such as directional and diffuse global radiation, external air temperature, relative humidity, wind speed and direction in addition to their pressure. In addition, further external air temperatures in addition to the directional radiation in the east, south and west directions are technically measured directly at the VERU building. In addition to the measured radiation data, the directional lighting levels are measured in the facade orientation in addition to horizontally on the roof of the VERU test building.

## Special limitations / possibilities

Up to 2010 the VERU test facility was especially used for investigations concerning the energetic behaviour of certain components or technical equipment. In the year 2010 there could be started a considerable retrofitting in order to realise two comparable test cells facing south. The energetic equality will be achieved by adiabatic layers in the boundary room elements: they can be heated or cooled by water registers. Thus comparative measurements of lighting systems, HVAC-systems, façade components etc. will be possible.



New weather station (since 2010) at the IBP Holzkirchen

## DATA ANALYSIS

### Typical equipment within test wall

To record all the energy flows relevant to the investigations, in addition to assessing the thermal and visual subjective comfort in the room, numerous measuring sensors are usually installed in each individual test room. The feed and return temperatures in the hydraulic circuits in addition to those in mass flows can be measured to record the heating and cooling performances. In each test room, air flow volume sensors can be built into the feed air and exhaust air circuits, and the temperatures at the air intake and air exhaust from the test rooms can be measured in order to balance the energy transport via the mechanical ventilation systems.

In addition to these energy balance ratios for heating, cooling and ventilation of individual test rooms, the electrical power consumption for artificial lighting in addition to the power consumption for internal heat sources can be measured additionally. The internal heat sources include heat given out by people in the rooms in addition to equipment such as computers, monitors, printers etc. This thermal quantity is added to the test rooms using so-called cooling load simulators. These are electrically heated tubes which have



Measurement of the illuminance at the south facade of VERU



Cooling load simulator



Temperature sensor for determining the operative temperature and air temperature

similar behaviour with regard to convective and radiation heat output to human beings.

Numerous measured variables for assessing the thermal comfort of the room can be recorded in addition to the energetic parameters. These are initially the air temperatures measured at various heights. In order to avoid possible heating up of the air temperature sensors by the incident solar radiation, a radiation protector consisting of a highly-mirrored plastic tube is fitted around the temperature sensor. In addition to the air temperature sensors, the operative temperature can be measured using a so-called globe thermometer. Furthermore, surface temperature sensors are often installed on the envelope surfaces on the floor, on the ceiling, at the partition walls and on the facade.

In addition to the surface temperature sensors, heat flow meters can be installed above the floor or above the ceilings in the neighbouring test rooms to assist in balancing the heat flows with whose help a more precise energetic balance is possible for individual test rooms.

In order to assess visual comfort or to check for sufficient brightness at workplaces, illumination level sensors can be installed at each workplace height.

A glare-free facade is essential for visual comfort in addition to sufficient lighting levels at the workplace. In order to assess the glare situation at the facade, additional luminance sensors can be installed in the rooms which record the major part of the transparent facade surface and whose measured mean luminance can be referred to as an assessment criterion for facade glare levels. Furthermore, this sensor signal can also be used for controlling the shade provider and less protection.

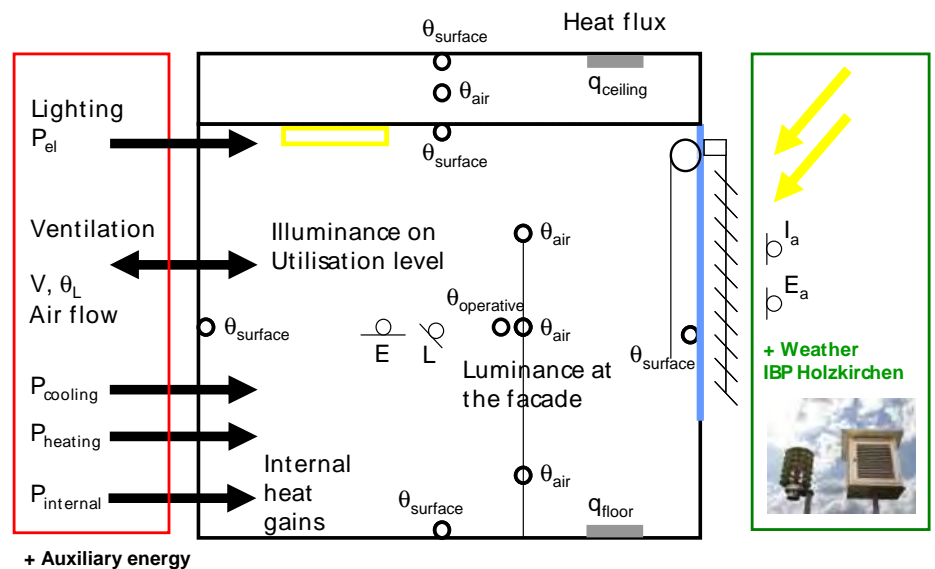

Measurement point overview in test rooms



$\theta_{RL}$	room air temperature (e.g. 0.1 m / 1.1 m / 1.7 m height)
$\theta_O$	operative room temperature (Globe thermometer at 1.1 m height)
$\theta_{OFT}$	surface temperatures of envelope surfaces
$P_{cooling}$	cooling output
$P_{heating}$	heating output
$P_{internal}$	internal heat source output
$V, \theta_L$	ventilation (feed/exhaust air)
$P_{el}$	electric lighting output
$E$	lighting levels at workplace
$L$	luminance at facade
$q$	heat flow density
$I_a$	direct radiation
$E_a$	vertical lighting levels

Depending on the building services fittings in individual test rooms, further sensory apparatus can sometimes be necessary in addition to the sensor components installed as standard. These are necessary, for example, for closer analysis of the decentralised air-conditioning technology in addition to the glass double facade. Numerous measurement sensors are also installed during heat and cold supply or distribution in addition to the thermal air treatment. These are used firstly for determining the are used for monitoring, checking and optimising of each individual component.

In addition to these permanently recorded measured variables, further measurement processes can be used during the investigations or during initial start-up and during regular control tests. These are, in brief, the procedure for determining the sealtightness of individual test rooms, the so-called blower door measuring process, and a measuring process for determining the actual air change rate in rooms with the help of a tracer gas - the so-called tracer gas measuring process. Determination of large-surface temperature distribution both inside the test rooms and outside on the VERU building can be carried out with the help of an infrared thermal imaging camera. Further analyses can be carried out with the help of a surface resolution luminance camera in addition to recording the mean luminance distribution via the fixed luminance sensors at the facade.

### Accuracy and logging resolution

The globe thermometer for determining the operative temperature in the room consists of a black-painted hollow copper sphere and a PT100 resistance thermometer in a stainless steel jacket with its sensor tip in the centre of the sphere. The accuracy of the temperature sensor is  $\pm 0.3$  K (DIN EN 60751 Class B). The temperature sensor for measuring the air temperature in the room works with a PT100 ceramic resistor covered in a radiation protector which prevents warming up of the sensor by direct sun radiation. The radiation protector consists of a self-adhesive mirrored film with a reflection ratio of 92 %. It is fitted on two centrally located tubes with diameters of 45 and 65 mm. the radiation detector is 100 mm high, the sensor is located at around 30 mm above the bottom of the tube. The accuracy of the temperature sensor is  $\pm 0.1$  K (DIN EN 60751 Class 1/3 B).

The  $V(\lambda)$  matching quality of the photometer head for light level measurement for assessment of lighting at the workplace in accordance with DIN 5032 T6 is  $f1 < 3\%$  (Class A) with a cosine-corrected spatial assessment



Photometer head for determining luminance (upper image) and lighting levels (lower image)



Airflow probe



Magneto-inductive flow meter for determining mass flows in heating and cooling circuits.

$f_2 < 1.5\%$ . The  $V(\lambda)$  matching quality of the photometer head with luminance attachment in accordance with DIN 5032 T6 is also  $f_1 < 3\%$  (Class A) with a cosine-corrected spatial assessment  $f_2 < 1.5\%$ .

Flow measurement takes place calorimetrically in accordance with the heat transmission principle. A heatable thermo resistance element is regulated to a constant overtemperature relative to the medium temperature. The heat emitted by the medium increases with increasing mass flow. The heating voltage is a direct measurement of the flow speed. Measurement accuracy is  $\pm 0.15$  m/s in addition to  $\pm 6\%$  of the measured value.

The mass flow of both the heating and cooling circuits are determined with the help of magneto-inductive flow meters in combination with high-precision PT100 immersion sensor thermometers. The immersion sensors for determining the feed and return temperatures have an accuracy of  $\pm 0.03$  K. The basic accuracy of the magneto-inductive flow meter is approximately  $\pm 0.5\%$  of the relevant measured value.

### Analysis of the data

The first step of data analysis is done by a software system developed at IBP and optimised for the requirements of structural physics research, called Imedas<sup>TM</sup>. It is a server-supported system which bundles all project information and makes it available to those participating in the measurement project via corresponding function modules. Editing takes place using a normal web browser. Imedas<sup>TM</sup> consists of the following individual modules:

- planning tools (test bench configuration)
- measurement and communication program
- visualisation with and without integrated HMI functions
- central database for measurement and condition values
- documentation and information system
- user and project management

With Imedas<sup>TM</sup> can be created graphs automatically which is useful for the first interpretations and the data control. The real analysis of the data is then done by other software tools (e. g. MS-Excel, Origin etc.). The kind of analysis depends strongly on the investigations and cannot be described blanket.

## EXAMPLES OF PREVIOUS STUDIES

The VERU test facility was built in 2002 and inaugurated in 2004. Since that time there were treated the following studies (extract):

- Metrological evaluation of the German regulation DIN V 18599 “Energy efficiency in buildings - Calculation of the energy needs, delivered energy and primary energy for heating, cooling, ventilation, domestic hot water and lighting”
- Development of a simple calculation method for the energetic behaviour of double skin facades
- Energetic evaluation of internal sun protection systems
- Investigations concerning the transmission of radiation through photovoltaic glass elements and their temperature behaviour
- Investigations on solar heat elements
- Probant test concerning the human performance under different indoor climate situations
- Investigations concerning the increase of efficiency of photovoltaic elements by cooling through PCM-elements

## MAINTENANCE / COLLABORATION

### Personnel involved

The VERU test facility is run by the group façade concepts (Group leader: Herbert Sinnesbichler) in the department energy systems of the IBP.

### International collaboration

There exists collaboration with the institute Tecnalia in Derio, Bilbao (Spain) and their test facility “KUBIK” which aims at similar investigations as VERU. IBP gave advice in the conception and design of “KUBIK”.

## RELEVANT LITERATURE

### General literature about the test facility:

There exist a general flyer about VERU in German and English which can be ordered at the IBP Holzkirchen.

### Literature on previous measuring campaigns:

Sinnesbichler, H. et al.: Weiterentwicklung und Evaluierung von Technologien und von Bewertungsmethoden zur Steigerung der Gesamtenergieeffizienz von Gebäuden (EnEff06), IBP-Bericht WTB-02-2007.

Heusler, I.; Sinnesbichler, H.; Erhorn, H.; Nimtsch, A.: Erarbeitung einer vereinfachten Berechnungsmethode für Doppelfassaden für die Integration in

die deutsche EPBD-Energieeffizienzbewertungsmethode DIN V 18599 (Bewertungsmethode GDF), IBP-Bericht Nr. ESB-002/2009 HOKI.

Sinnesbichler, H.; Eberl, M.: Temporärer Wärmeschutz durch Rollläden mit Infrarot reflektierender Oberflächenbeschichtung, IBP-Mitteilung 496, 36 (2009).

Heusler, I.; Kersken, M.; Sinnesbichler, H.: Untersuchung der Potenziale von innen liegenden Sicht- und Sonnenschutzsystemen zur Verringerung des Heizwärmebedarfs von Gebäuden, IBP-Bericht ESB-007/2009 HOKI.

Hauser, G.; Sinnesbichler, H.; Eberl, M.: Nächtliche Kühlung mittels eines modifizierten Solarkollektors, IBP-Mitteilung 498, 37 (2010).

# TWIN HOUSES - IBP HOLZKIRCHEN



## GENERAL DESCRIPTION

### Main objective of the test facility

Two identical buildings in single-family-house size are located on the outdoor test site of the Fraunhofer Institute for Building Physics, south of Munich. These so called twin houses allow comparative investigations of building components and technical equipment with the aim of comparing the energy efficiency under identical weather conditions.

### Overall lay-out

The twin houses were built in 1980 in size of a single family home with basement, ground floor and attic. They are identical in construction and orientation. The pitched roof is sloped by 30°.

Institute/organisation:



Fraunhofer Institute for Building Physics  
Holzkirchen Branch  
Department Energy Systems  
Germany

Contact person:

Dipl.-Ing. Herbert Sinnesbichler  
Fraunhoferstr. 10  
D-83626 Valley  
tel: +49 8024/643-241  
e-mail: herbert.sinnesbichler@  
ibp.fraunhofer.de

Exact location:

Holzkirchen, Germany

47.88° N, 11.73° E  
Elevation above MSL 680 m

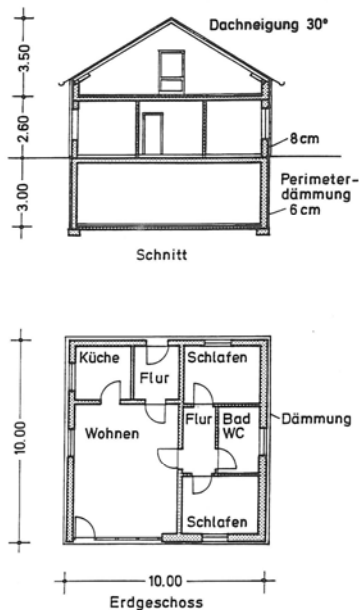

Plan of the twin houses



Living room during investigations



Blower Door device in attic

The ground floor has an area of around 82 m<sup>2</sup> and is subdivided in 7 rooms, typical for one family. The exterior walls are made from brick with 8 to 12 cm of ETICS. They are non-load-bearing, since the structure consists of 4 concrete columns, so that even the exterior walls may be removed respectively substituted.

The basement with its exterior entrance has exterior walls of concrete with 6 cm of thermal insulation. The technical equipment in the basement provides the control and distribution of heating, cooling, ventilation and electricity.

The attic may be reached from the ground floor by an air tight hatch. It consists of two rooms. The pitched roof with the slope of 30° has rafters with a distance of 68 cm.

The buildings are permanently updated to the average insulation standard. By means of adiabatic separation it is even possible to investigate parts of the houses.

The houses had a complete retrofitting in 2010 to reach the current average insulation standard.

### Inside boundary conditions

The buildings are equipped with basic components:

- basement: gas condensing boiler, hot water storage, cooling component, electrical power distribution and control,
- ground floor: panel radiators, floor heating system, ventilation system
- attic: cooling and ventilation system
- windows: equipped with roller blinds, which may be controlled electrically.

### Outside boundary conditions

Climatic data recording is carried out by the central weather station at IBP Holzkirchen, which is located next to the twin houses. This records the most important meteorological boundary conditions such as directional and diffuse global radiation, external air temperature, relative humidity, wind speed and direction, rain and air pressure.

The Holzkirchen weather is characterized by cold winter, high solar radiation and wind.

### Special possibilities

There are two identical buildings, which have a typical one-family-house size and are only used for testing. They are unshaded and allow comparative measurement under identical weather conditions. The use of both buildings may be simulated by controlling cooling load simulators. They allow testing of

different building components. Most components may be either removed or substituted by test components.

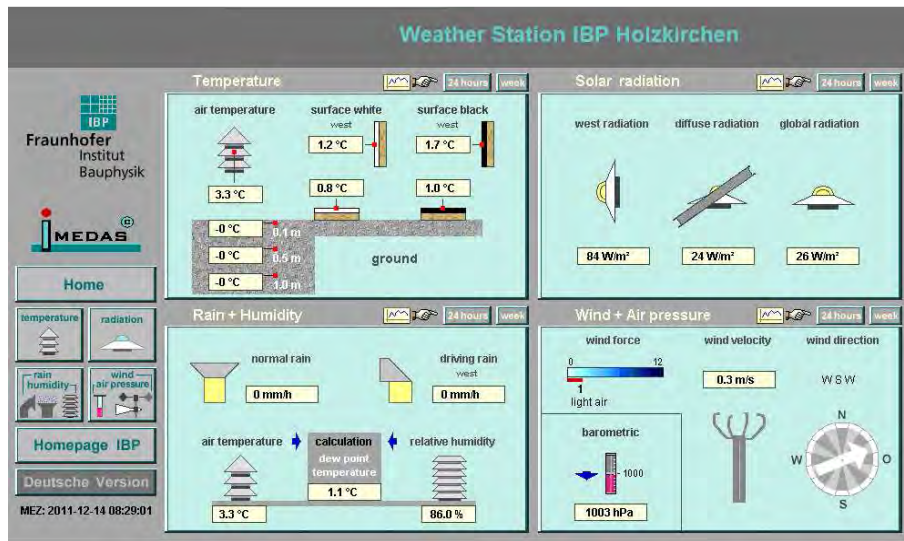

Visualization of weather data

## DATA ANALYSIS

### Typical equipment within test wall

To guarantee identical boundary conditions, investigations start with a reference measurement which also comprises checking the air tightness by a blower door test and thermography as needed. During all investigations air temperatures and operative temperatures are measured. Therefore all rooms are equipped with temperature sensors and globe thermometers. Heat flux meters are used to measure the heat flow density.

To provide identical boundary conditions the buildings are not used by people. The heat emission of people as well as the heat emission of their used domestic appliance are applied by so called “cooling load simulators”. Those simulators are controlled according to a user profile for each room.

### Accuracy and logging resolution

The used temperature sensors consist of a Pt100 ceramic cylinder type, which is surrounded by a radiation protector to prevent warming by direct solar radiation. The globe thermometer to measure the operative temperature, that is ambient air temperature including radiation content, is made up of a black coated copper ball of 100 mm diameter and a Pt100-RTD in a stainless sheath.



Temperature sensor



Globe thermometer



Cooling load simulator



Visualisation of measured data

To record the heat flows heat flux meters are used. They consist of a large number of thermocouples connected against each other, embedded in a thin epoxy resin layer. The temperature on either side of the heat flux plate is measured. The temperature difference flow emitted as voltage gives a heat flow density.

For investigations concerning HVAC all supply and return temperatures in the hydraulic circuits and additionally the mass flow are measured to record the heating and cooling performances.

The overall accuracy depends on the object and has to be determined individually.

### Analysis of the data

The central control of the test facility is managed by a modular storage-programmable control system (SPS). Measurement data are collected by IMEDAS™ (a specialised data acquisition system that was also developed by IBP) which also communicates with the central control unit, storing relevant process data and system states in the central data base. Furthermore, Imedas™ enables engineers to visualize processes that are currently occurring at measurement sites via the intranet and the internet. Settings and boundary parameters can be modified and controlled from any workplace, protected by passwords, thus allowing to display latest test-facility data at trade-show presentations, for potential clients and in one's own company.

## EXAMPLES OF PREVIOUS STUDIES

Since the 1980 several comparative investigations have been carried out (Selection):

- Combination of energy saving measures
- Sunspaces
- Demand controlled ventilating systems, heat recovery
- Decentralized heating pump versus central heating pump
- Roof systems
- Transparent insulation, ETICS, plaster



## MAINTENANCE / COLLABORATION

### Personnel involved

The twin houses are run by the group façade concepts (group manager: Herbert Sinnesbichler) in the department energy systems (head of department: Dr. Dietrich Schmidt) of the Fraunhofer Institute for Building Physics, Holzkirchen Branch.

### International collaboration

In the context of the European research project “FIEMSER” the twin houses will be used for the validation of an intelligent control system for residential houses.

## RELEVANT LITERATURE

### General literature about the test facility:

Werner, H.: Zwillingshäuser des Fraunhofer-Instituts für Bauphysik. TAB 1/1983, S. 15-19

Leonhardt, H.: Sanierung der Außenhülle eines Gebäudes und ihr Einfluss auf den Heizwärmeverbrauch. Bauphysik 19(1997), Heft 2, S. 41 - 45

### Literature on previous measuring campaigns:

IBP Mitteilung 495 2009, G. Hauser, A. Schade, H. Sinnesbichler, Potentiale und Grenzen von Infrarot reflektierenden Dämmmaterialien

IBP Mitteilung 508 2011, Michael Eberl, Almuth Schade, Herbert Sinnesbichler, Decentralized Circulation Pumps

IBP Mitteilung 509 2011, A. Schade, H. Sinnesbichler, Testinstallation von fassadenintegrierten Netzwerkstrukturen

Hauser, G.; Kersken, M.; Schade, A.; Sinnesbichler, H.: Experimentelle und theoretische Untersuchungen von Infrarot reflektierenden Dämmmaterialien. Bauphysik 33(2011), Heft 1, Seite 33 - 42.



## ZERO ENERGY CERTIFIED PASSIVE HOUSE TEST-BUILDING IN MEDITERRANEAN CLIMATE



### GENERAL DESCRIPTION

#### Main objective of the test facility

The full scale test facility is a pilot project consisting in a zero energy building located in the municipality of Mascalucia (Catania) in the region of Sicily.

The building is designed as zero-energy building and it's certified according to *Passivhaus* standard, respecting requirements in terms of thermal performance and air tightness. The reduction of energy need is accompanied by the local production of renewable energy by means of photovoltaic modules, a thermal solar system and a earth to air heat exchanger (EAHE) in the mechanical ventilation system.

In particular, the EAHE provides pre-heating or pre-cooling to the air supplied by the ventilation system. The supply-air temperature can be further adjusted by means of a heat recovery unit and a heating / cooling coil before entering the indoor environment. A solar thermal system is integrated with a heat

Institute/organisation:



end-use Efficiency Research Group  
Energy Department  
POLITECNICO DI MILANO

Contact person:

Prof. Lorenzo Pagliano  
Via Lambruschini 4  
20156 Milano - ITALY  
tel: +39 02 2399 3870  
[lorenzo.pagliano@polimi.it](mailto:lorenzo.pagliano@polimi.it)

Exact location:

Mascalucia (Catania), Sicily  
ITALY  
37.57° N. 15.05° E



Earth to Air Heat Exchanger here in phase of construction (3 tubes, 10 m long each, 3 m deep). It was designed by eERG-PoliMI in order to maximize energy performances and to have a good layout for monitoring it.



Inlet ducts of Earth to Air Heat Exchanger

pump generator. The complex system is automatically regulated by a building automation system supported by KNX protocol. The dwelling also benefits from natural ventilation (cross ventilation) - especially for night cooling - enhanced by an internal patio and the optimal layout of window openings.

### Overall lay-out

The zero-energy building will be continuously monitored in order to reach a deep understanding of the physical and comfort conditions occurring in the indoor environment at different outdoor conditions, and the total energy consumption of the building. In particular, the planned monitoring campaign addresses air and operative temperatures, relative humidity, CO2 concentration and air velocity in different points of the structure, including all rooms, the patio and the garden. In addition, the heat flows through the building envelope and the electricity consumption of fans and all other equipment will be continuously monitored so to evaluate the effective building performance.

The building is a single family residential house, as shown in the figure below.



Architectural layout of the zero-energy building test facility in Mascallucia.

### Inside boundary conditions

Temperature, relative humidity, and carbon dioxide concentration of indoor air are controlled by the HVAC system in function of chosen set-point values and scheduled. Monitoring will consider the real behaviour of the occupants, which will be monitored too by logging indoor hygrothermal variables, but

also windows opening for natural ventilation and electrical consumptions for lighting and equipments.

### Special limitations / possibilities

The full zero-energy building is characterized by high insulation and airtightness level. It will be monitored in the mediterranean climate in real conditions and with occupants behaviour.

The building automatic control system allows us to monitor and evaluate different strategies for the control of automatic solar protection and mechanical ventilation, also with the integrated earth to air heat exchanger, and considering the real dynamic effects for the heat of storage in building components.



External movable solar shading blinds, automatic controlled. The actual position of them will be logged at each time step.

## DATA ANALYSIS

### Typical equipment within test wall

There will be monitoring of temperatures, mass flow rates, energy flows of all loops of the heating, cooling, ventilation, and solar heating systems of the building. There will be monitored the energy needs for heating, cooling, and domestic hot water, the electrical energy need for lighting and electrical equipments, the total primary energy demand, the energy production by thermal solar system and photovoltaic ones.

In each room there will be monitoring of indoor air temperature, operative temperature, air relative humidity, air CO<sub>2</sub> concentration, interior surface temperatures in some points of the envelope, illuminance level.

A detailed monitoring layout was installed for the earth to air heat exchanger with several sensors for temperatures (PT100, class A accuracy, 4 wires connection) and moisture content in the ground.

Also a detailed monitoring of the operation of air to air heat recovery system will be performed with the installation of air temperature and relative humidity sensors, air mass flow rate sensors and electrical consumption measurements of fans.

### Accuracy and logging resolution

All the thermistors already installed in the ground are of type PT100, with Class A of accuracy and 4 wires connections. Other sensor and monitoring equipment are now in phase of purchasing and installation, with the aim to guarantee a high level of accuracy.

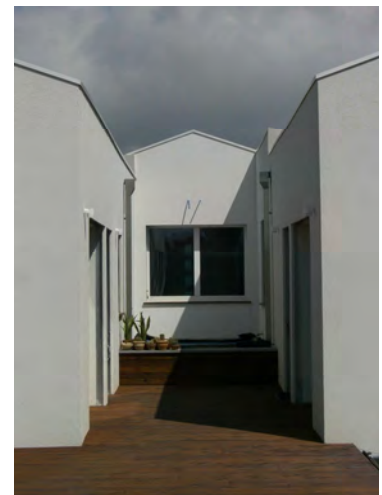

The external patio, where air temperature will be monitored to see the effects on the natural ventilation crossing the building.



Earth to Air Heat Exchanger here in phase of construction (3 tubes, 10 m long each, 3 m deep). It was designed by eERG-PoliMI in order to maximize energy performances and to have a good layout for monitoring it.



High level of thermal insulation of the envelope.

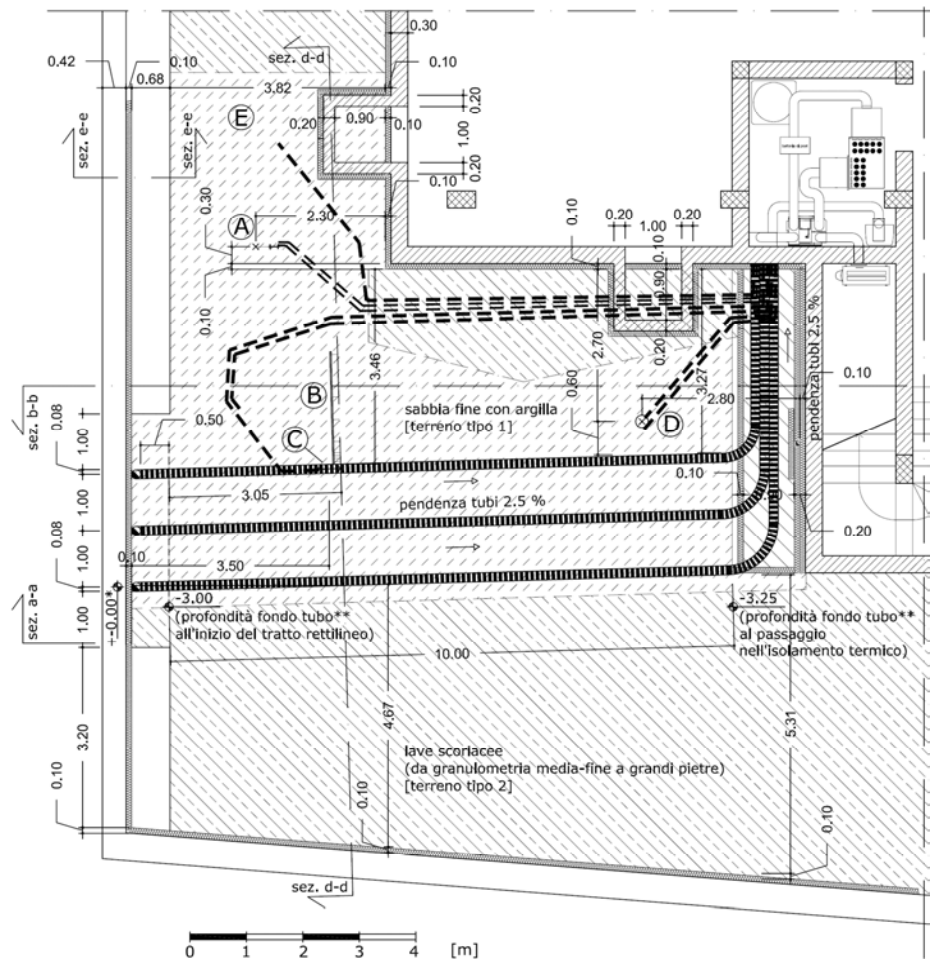

Monitoring layout for the Earth to Air Heat Exchanger, with thermal resistances PT100 and moisture content several sensors in the ground.

## Analysis of the data

Following analysis activities are planned:

- Long term monitoring of the energy consumption and the indoor hygrothermal comfort variables;
- Long term monitoring of the occupant behaviour (windows opening for natural ventilation, use of automatic solar shading devices, etc.);
- Calculation of long term comfort indexes;
- Feedback and outcomes about mechanical/natural ventilation strategies and solar shadowing strategies;
- Time series analysis techniques;
- Parameter identification for building and systems;
- Dynamic model calibrations for the whole building and for the Earth to Air Heat Exchanger installed to perform further analysis.

## MAINTENANCE / COLLABORATION

### Personnel involved

The eERG-PoliMI Group, the end-use Efficiency Research Group of the Politecnico di Milano, directed by Prof. Lorenzo Pagliano, is responsible for the monitoring activities and the installation and use of monitoring equipment of this full scale test facilities.

### International collaboration

The zero-energy test building is a case study in the European research project PassREg - Passive House Regions with Renewable Energies ([www.passreg.eu](http://www.passreg.eu)), about the development of zero-energy buildings in cities and region of Europe. The PassREg project has eERG-PoliMI as partner in a large European consortium and Passivhaus Institute as coordinator organization.

### Link to other devices

eERG-PoliMI manage a diffuse laboratory with different monitored buildings in Italy, e.g. in Lombardia region, in Marche region, in Piemonte region. The aim is to perform monitoring activities in full scale real building with zero-energy and high energy performances.

## RELEVANT LITERATURE

### General literature about the test facility:

[http://www.eerg.it/index.php?p=Progetti\\_-\\_Botticelli](http://www.eerg.it/index.php?p=Progetti_-_Botticelli)

### Literature on previous measuring campaigns:

Long and short term comfort surveys in several Italian building in European research project CommonCENSE - Comfort monitoring for CEN standard EN 15251 linked to EPBD ([www.commoncense.info](http://www.commoncense.info)).







## GENERAL DESCRIPTION

### Main objective of the test facility

The experimental platform "DEFI" was designed and constructed within the framework of International Energy Agency Annex 58 project and a French-Moroccan partnership involving the ENTPE (university of Lyon) and the "Direction des Equipements Publics (Rabat)". The purpose is to supply (numerical and experimental) methodologies and tools for the design and characterisation of the global performance of buildings. These tools belong to the groundwork for the creation of a research centre, which aims to contribute to the improvement of energy efficiency in buildings and to give decision-making support and advice for Green Building.

Institute/organisation:



Contact person:  
Mohamed El Mankibi  
Tel: +33472047278  
mohamed.elmankibi@entpe.fr

Exact location:  
Tafraoute, Morocco  
Lat="29.709339" Long="-8.993859"



Location



Plan of the Villa DEFI



External view



Heat Pump and Ground heat exchanger

Objectives:

1. Models Assessment and adjustment: thanks to the capacity of DEFI platform to produce different real scale configurations (Heating, cooling, ventilation, latent energy storage), the recorded sensors and actuators results are used to adjust, calibrate and assess building thermal and aeraulic models. In particular the new models to be developed by Moroccan Public works Direction.
2. New Moroccan thermal regulation standards validation: The requirement of RTCM (Moroccan building thermal standard) specifications and forecasted performances will be assessed thanks to a whole year experimentation
3. Occupant’s Behaviour assessment: This experimentation aimed also to host volunteers (families) for at least 15 days for each family and monitor the behaviour (Heating, Ventilation, opening and shading operations, cooking, ...) in order to evaluate the impact of occupant’s behaviour with and without BEMS.
4. Systems performances assessment: Thanks to its rich Data acquisition system and removable installed systems, DEFI ha also the flexibility to change and assess the performance of the building systems and envelope (Heat pumps performances, PCM-Air exchangers,
5. Renewable Energy Integration assessment: the next stage of DEFI development is to evaluate the potential of current Renewable Energy technology to afford Net-Zero Energy Buildings.

Overall lay-out

« DEFI » platform is a reinforced concrete construction which complies with Moroccans’ seismic standards and ADEREE (Moroccan Energy Efficiency Agency) thermal standards; this multizone building is composed of 3 bedrooms, a living room, a kitchen and a bathroom. An extra room is allocated for data acquisition and control system.

The main architectural and envelope components are:

- Reinforced concrete beam
- Concrete block + Polystyrene + concrete block
- Double pane argon windows

Inside boundary conditions

In each zone of DEFI platform (9 zones including technical room and corridor), indoor air temperature, CO<sub>2</sub> levels and relative humidities are monitored every 15 seconds thanks to fixed sensors in order to establish the indoor air

conditions. In addition movable thermal comfort stations (air temperature, globe temperature, air velocity, relative humidity) can be placed at any location of the 9 zones.

Opening, doors and shading position sensors are installed and can monitor any behaviour related to openings and shading. Air temperature, Relative humidity and air velocity sensors are also placed in each duct inlet and outlet in order to monitor inlet and outlet mechanical airflow conditions.

## Outside boundary conditions

The outside conditions are measured with a weather station (temperature, humidity, solar irradiance, wind speed and wind direction, far infrared radiation). Heat flux in each façade, surface temperature sensors on the glazing, ground temperature sensor and water temperature sensor are also installed to have the outdoor boundary conditions.

## Systems

« DEFI » platform is equipped with the following systems:

- Air-Air reversible heat pump: this system is used to heat and cool the building with specific supply for 4 zones (Rooms and Living rooms). The supply air temperature can be controlled thanks to radio frequency remote controls.
- Double flux ventilation system with heat recovery system
- Air to Earth heat exchanger: Unique duct with a length of 30 m and depth of 3 m.
- Automatic and manual shading device.
- Phase change materials heat exchanger: this system is used to shift the heating during 2 hours between 6 pm and 8 pm.

## Other possibilities

This facility could also be used for the characterization of the occupants' behaviour, hybrid cooling systems and assessment of renewable solar energy potential.

# DATA ANALYSIS

## Typical equipment

The data acquisition and control system is built of "National Instruments" modules. The data acquisition system software, developed via LabVIEW, can automatically apply simple control strategies (on/off or PID controllers) or



Data acquisition and control system



Temperature, humidity and CO<sub>2</sub> sensors



Duct Air speed , T and RH sensors



Shading device position sensor



Weather station



Thermal confort stations



Main user interface



Blower Door Tests

advanced control strategies (fuzzy logic, genetic algorithm, neural network optimisation).

A touch-screen human interface device can be found in the corridor; the whole system can also be monitored and controlled via internet and via smart devices (Phones, apps for tablets)

The sensors and actuators of data acquisition system are:

- Temperature, humidity and CO<sub>2</sub> sensors in each room
- Windows opening/closing sensors
- Shading device position (linear wire potentiometer)
- Temperature, humidity and air velocity at the inlet and outlet of the ground heat exchanger
- Soil temperature
- Energy meters for each usage
- Hot water and cold water consumption meter
- Complete thermal comfort station ISO 7730

## Analysis of the data

Matlab/Symulink signal processing toolbox and LabVIEW features are used to acquire the signals, enhance their quality and the statically treatment.

# MAINTENANCE / COLLABORATION

## Personnel involved

The building is maintained by technical staff of the LGCB-ENTPE laboratory in collaboration with the responsible engineering.

## International collaboration

The experimental platform "DEFI" was designed and realised within the framework of International Energy Agency Annex 58 and is currently used as experimental setup in French-Italian-Moroccan studies (ENTPE - Politecnico di Torino and Direction des Equipements of Morocco). The experiment is also a case study of IEA ECBS Annex 31 "Energy Storage with Energy efficient Buildings and Districts" in a collaboration between ENTPE-university of Lyon and University of Colorado at Boulder.

# ARFRISOL Buildings-UIE3-CIEMAT



Institute/organisation:



Energy Efficiency in Buildings R&D Unit. CIEMAT. Spain

Authors:

R. Olmedo, M.N. Sánchez, R. Enríquez, M.J. Jiménez\*, M.R. Heras  
Avda. Complutense 40  
28040 Madrid, SPAIN

\*Contact:

tel: 34950387800; Ext.: 922  
e-mail: mjose.jimenez@psa.es

Exact locations:

Almería, Spain  
36°50'N, 2°24'W

Madrid, Spain  
40°27.3'N, 3°43.8'W

Tabernas, Almería, Spain  
37.1°N, 2.4°W

San Pedro de Anes, Asturias, Spain  
43°25'N, 5°42'W

Cubo de la Solana, Soria, Spain  
41°36'N, 2°30'W

## GENERAL DESCRIPTION

### Main objective of the test facility

The PSE ARFRISOL ([www.arfrisol.es](http://www.arfrisol.es)) Research Energy Demonstrator Office Building Prototypes (C-Ddl) are part of the tests facilities of the Energy Efficiency in Building R&D Unit (UiE3) belonging to CIEMAT Energy Department's Renewable Energies Division.

The UiE3 carries out R&D in the different aspects of energy analysis of buildings, integrating passive and active solar thermal systems to reduce and manage the heating and cooling demand. This unit is organised in three lines of research focusing on: 1.-Energetic Analysis of Buildings by simulation, 2.- Study of Passive Systems in Buildings and Urbanism, and 3.-Experimental Energy Evaluation under Real Conditions. The test facilities described are under the last of these.

The PSE ARFRISOL C-Ddls are fully instrumented Energy Research Demonstrator Office Building Prototypes which are in use and monitored continuously by a data acquisition system. CIEMAT owns 3 of 5 of these

“*Contenedores Demostradores de Investigación, C-Ddls*” (Research Energy Demonstrators Building Prototypes), built under the ARFRISOL Project. Each of them is an approximately 1000m<sup>2</sup> built area office building. They are in different representative locations of Spanish climates. These C-Ddls are designed to minimize energy consumption by renewable energy feed heating and air-conditioning systems, whilst maintaining optimal comfort levels. They therefore include passive energy saving strategies based on architectural and construction design, have active solar systems that supply most of the energy demand (already low), and finally, conventional auxiliary systems to supply the very low demand that can not be supplied with solar energy, using renewable energy resources, such as biomass insofar as possible.

These prototypes were built for high-quality measurements recorded during monitoring to support research activities on thermal comfort, energy performance analysis and both active and passive systems integration in buildings.

These prototypes were built in the framework of the Singular Strategic Project on Bioclimatic Architecture and Solar Cooling (PSE-ARFRISOL project, 2005-2012). This project was supported by the Spanish Ministry of Science and Innovation (MICINN), former Ministry of Education and Science (MEC), being its main objective to demonstrate the usefulness of bioclimatic architecture and solar thermal and photovoltaic to save energy in future buildings.

Once finished the PSE-ARFRISOL project, the five building prototypes are very useful and valuable full scale test facilities continuously monitored and being regularly used as office buildings, which are available for future research projects in the field of Energy Efficiency in Buildings.

## Overall lay-out

The C-Ddl PSE-ARFRISOL, have the following passive strategies common to all of them:

- Use of envelope and structure thermal inertia.
- Optimized direct solar gain through glazed openings.
- Optimized indirect solar gain through opaque walls.

Similarly, all C-Ddls, integrate the following common active solar strategies:

- Solar thermal collectors for hot water, heating and cooling.
- Absorption refrigeration pumps.
- Integrated photovoltaic modules.

The five different building prototypes (C-Ddl) are described in the following.

### C-Ddl CIESOL

The so called C-Ddl CIESOL located at the campus of the University of Almería (south east of Spain). It hosts a joint centre between this University and CIEMAT-PSA. It is a newly built prototype, with L-shaped plan with yard and two floors with a floor area of 1072 m<sup>2</sup>. Taking into account that it is located in a humid Mediterranean climate passive bioclimatic strategies have been accordingly implemented, the most important addition to the common of them all are the following:

- Design differentiated facades and window openings.
- Ceramic skin ventilated facades south and east-facing and corrugated plate north and west-facing.
- Natural cross ventilation.
- Solar control through holes setback.
- Metal-covered shading pergola supporting PV modules.



C-Ddl CIESOL



C-Ddl ED70 CIEMAT

### C-Ddl ED70 CIEMAT

The so called C-Ddl ED70 CIEMAT located Madrid and is one of the buildings belonging to CIEMAT premises, is a prototype of a new plant, extension of an existing building, in a medium continental climate. Its plant is rectangular and comprises three stories plus a basement adding a total floor area of 2000 m<sup>2</sup>. The most important passive bioclimatic strategies, in addition to common of these, are:

- Ceramic skin ventilated facades.
- Different insulation thickness in the different orientations.
- Glass PV system as south facade shading.
- Solar thermal collector pergola support as shading housing.



C-Ddl ED70 CIEMAT. PV shading devices

In addition to the solar strategies common to all buildings, this C-Ddl has the following energy efficiency systems:

- Induction HVAC system.
- Lighting control system according to the natural light.



C-Ddl PSA

### C-Ddl PSA

The so called C-Ddl PSA located at the Plataforma Solar de Almeria (PSA) in Tabernas (Almería) in a semi-arid climate with large day-night temperature variations is a prototype of a new plant. It is one of the buildings belonging to CIEMAT premises. It is built on one floor longitudinal plan, with a constructed area of 1115 m<sup>2</sup>. The most important bioclimatic strategies, in addition to common of these, are:

- Design differentiated facades.



C-Ddl PSA. Double-wing shading



C-Ddl PSA. Solar chimneys

- Different insulation thickness for the different orientations.
- South facade shading by setback.
- Double-wing shading roof structure to support thermal collectors and night cooling system.
- Solar chimneys-induced office natural ventilation.
- Air-to-air earth heat exchanger.
- Daylight and ventilation strategies at the corridor.

In addition to the solar strategies common to all buildings, this C-Ddl has the following energy efficiency systems:

- Lighting control system according to the natural light.
- HVAC by induction and radiant floor.
- Innovative night radiant cooling system coupled to radiant floor.



C-Ddl F. Barredo

#### C-Ddl F. Barredo

The so called C-Ddl F. Barredo is located in San Pedro de Anes, Asturias, in a humid continental climate. It is a 1400 m<sup>2</sup> new plant building with a three arms plant distributed to account for a three orientations benefits. It uses different materials, sizes and thicknesses of insulation holes in their facades according to their orientation, always local ones such as Covadonga stone and chestnut wood. Implemented passive strategies, include the following:

- Differentiated façades according to the orientation.
- Summer-ventilated greenhouse gallery.
- Different thickness of insulation depending on the orientation.
- Solar control by shading facades with parasols trays.
- Natural cross ventilation.
- Ventilated roof.



C-Ddl F. Barredo. Greenhouse gallery

In addition to the passive strategies common to all buildings, this C-Ddl has the following active solar systems:

- HVAC by radiant floor heating and fan coil units.
- Biomass heat production.
- Water-to water borehole system.

#### C-Ddl CEDER CIEMAT

The so called C-Ddl CEDER CIEMAT, located in *Cubo de la Solana*, Soria, with continental climate which is considered extreme regarding Spanish climate. It is one of the buildings belonging to CIEMAT premises. It is a refurbishment of a 1200 m<sup>2</sup> building. The refurbished two storeys building,



C-Ddl F. Barredo. parasols trays in the west wing



## PART 2: Facilities for energy use analysis at whole building level

rises from a rectangular plant. The most important bioclimatic strategies, in addition to common of these, are:

- Differentiated façades according to orientation.
- Glass-fiber Reinforced Concrete (GRC) ventilated facades.
- Comfort-optimized glazed two-floor common area.
- Thermal inertia optimization.
- Natural cross ventilation
- Double-wing shading roof structure to support thermal collectors and night cooling system.

This C-Ddl has the following active solar systems:

- HVAC by floor heating and fan coil units.
- Biomass heat production.
- Water-to-water borehole system.

### Inside boundary conditions

These building prototypes are regularly used as office buildings. Taking into account the typical pattern of use of this type of buildings they have several possibilities for test campaigns.

Long test campaigns in occupancy conditions corresponding to the regular use of the buildings are available. In this case indoor conditions are usually within the comfort limits. In these periods the occupants are free to use the building and open and close doors and windows. However in these periods it is forbidden the use the heating and cooling system to generate power sequences, which could optimise the data analysis, to avoid perturbations in the normal life of the users.

Shorter test campaigns with the buildings empty are also available corresponding to periods of holidays, typically fifteen or thirty days. In these periods it is possible to use the heating and cooling system as well as other simplest systems, such as auxiliary electric heaters, to generate power sequences, to optimise the data analysis. If necessary the building can be out of the comfort bands in these test periods.

Taking into account the buildings size, a detailed monitoring of each room was considered not affordable, and some rooms were selected according their representativeness into the building. A comprehensive set of sensors is installed in order to be able to quantify all the contributions to the energy balance into the selected rooms in both cases: empty building and occupancy conditions.



C-Ddl CEDER



C-Ddl CEDER. Radiant night cooling system

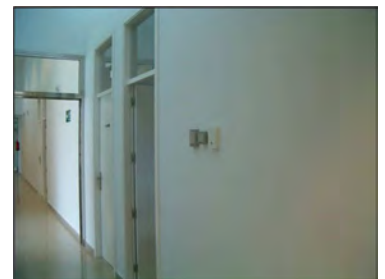

C-Ddl PSA. Corridor and some of the sensors installed

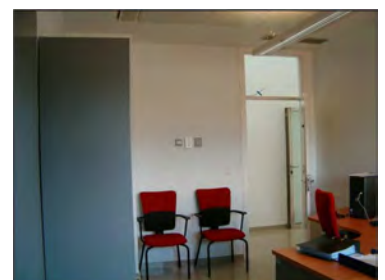

C-Ddl PSA. Monitored room and some of the sensors installed

## Outside boundary conditions

Testing is done under outdoor weather conditions. Location of the buildings has been chosen such that all Spanish weathers are represented by one of them as follows:

- The C-Ddl CIESOL is in Almería where weather is humid Mediterranean.
- The C-Ddl ED70 is in Madrid where weather is a moderate continental.
- The C-Ddl PSA is in Tabernas where weather is dry Mediterranean.
- The C-Ddl F. Barredo is in Asturias where weather is humid continental.
- The C-Ddl CEDER is in Soria where weather is extreme continental.

Meteorological sensors are installed on the roof of each C-Ddl, and they are installed as follows: south horizontal solar radiation, longwave radiation, air temperature, relative humidity, wind speed and direction.

## Special limitations / possibilities

The C-Ddls were built and instrumented with the aim of being support to research activities in the areas of thermal comfort, identification of deviations between simulations and experimental measurements, characterization and evaluation of the building envelope, and evaluation of active systems.

The possibilities for test campaigns are quite flexible as follows:

- Long test campaigns in occupancy conditions corresponding to the regular use of the buildings, with indoor conditions within the comfort limits, occupants free to use the buildings. In these periods perturbations in the normal life of the users are forbidden.
- Shorter test campaigns with the buildings empty corresponding to periods of holidays, when it is possible to use heating and cooling system to generate power sequences, to optimise the data analysis. If necessary the buildings can be out of the comfort bands in these test periods.

Some of these buildings are surrounded by trees or in urban environment which is a challenge regarding calculating the solar radiation which reach the window surface from the usual measurements of solar radiation (global horizontal).

Some of these buildings are in locations with moderate climates, where there are long periods with a very low difference of temperature between air indoor and outdoor and high level of solar radiation. These test conditions complicate the identification process regarding the characterisation of the building envelope, in the sense that in these outdoor conditions the amplitude of PRBS and ROLBS heating sequences (sometimes useful to ease calculations) is very limited, and consequently, it is less effective as a test strategy for exciting the system and decorrelating the signals, which makes identification of the required parameters more difficult. Multi-output models have been very useful to solve this problem in previous studies (Jiménez and Heras, *Solar Energy*. 79(3), pp. 302-310; Enriquez et al. *Energy Procedia*. 30, pp. 580-589).



Meteorological devices and box containing data acquisition modules at the bottom of the mast

## DATA ANALYSIS

### Typical equipment in each building prototype (C-Ddl)

As mentioned, taking into account the building size, 1000m<sup>2</sup> approximately, a detailed monitoring of each room was considered not affordable, and some rooms were selected according their representativeness into the building. This selection criterion was based in the use of the building and each of its rooms and also in the constructive characteristics of these rooms. Additionally some measurements were done in the adjacent rooms and corridor to take into account the boundary conditions. Less detailed measurement were also implemented in other rooms in order to carry out other studies and qualitative analyses.

The experiment set up was inspired in the experiment set up carried out in PASLINK tests by this team. However this set up has been adapted to take into account the main differences between test cells and in use buildings which are mainly related to boundary conditions and presence of users as follows:

- The boundary conditions are not controlled, then the following measurements are included for each monitored room: air temperature in the adjacent rooms, temperature of the floor surface, temperature of the glass surface, water flow and inlet and outlet temperatures associated with cooling and heating, temperatures below the ground at different levels, one just under the floor tiles and the other 1m buried.
- The users influence the building performance as ventilation rate can be changed by the operation of doors and windows. Then it is recorded: if doors and windows are closed or “not closed”.
- There is a contribution to the energy balance into the room due to the users’ metabolic activity. So the following measurements are included in each room: concentration of CO<sub>2</sub>, relative humidity, electric consumption due to computers and lighting.
- Air leakage is not negligible, so the following measurements are included: Outdoors wind speed and direction, indoor and outdoor CO<sub>2</sub> concentration. It is also recorded if doors and windows are closed or “not closed”.

In summary the experimental measurements available in the main monitored rooms are: air temperature, relative humidity, CO<sub>2</sub> concentration, temperature of the walls, floor and glass surfaces, water flow and inlet and outlet temperatures associated with cooling and heating system, electric consumption due to computers and lighting, temperatures below the ground at different levels. It is also recorded if doors and windows are closed or “not closed”.



Magnetic switches to detect if doors are closed or not closed



Sonic anemometer



Box containing data acquisition modules

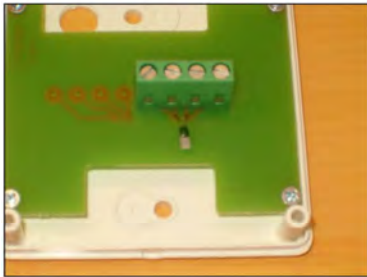

Platinum thermoresistance. PT100 sensor element



Installed indoor air temperature (left) and relative humidity sensors (right)

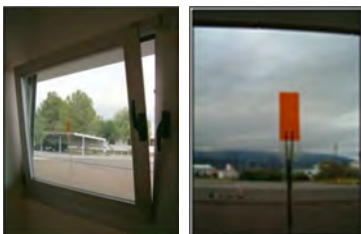

Installed glass surface temperature sensors

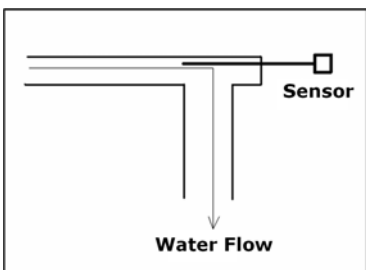

Scheme of installation of water temperature sensors in pipes

## Accuracy and logging resolution

The following aspects have been considered to achieve the required measurement accuracy:

- Accuracy of the measurement transducers.
- Sensor position (and distribution if necessary), installation and accessories, for good representation of the measurand.
- Data acquisition system: 16-bit A/D resolution, range of measurements fitting sensor output, modules distributed to minimise wiring.
- Twisted pairs and grounded shield are employed to reject noise and avoiding perturbations from wiring.

The following list summarises the instrumentation used for these measurements.

- Air temperature: Platinum thermoresistance, PT100, 1/10 DIN, directly measured using a four-wire connection, with a solar radiation shield and ventilated for outdoor measurements.
- Surface temperature: Analogous sensors and connections as those used for air temperature, in this case built in the corresponding surface.
- Ground temperature: Analogous sensors and connections as those used for air temperature, in this case using a more robust rubber protected sensor.
- Water temperature in pipes: Analogous sensors and connections as those used for air temperature. In this case the following have been considered to ensure a good sensor installation: Modifications in the pipes to insert the probes, high thermal conductivity stuff to guarantee good contact between sensors and pipes, and external insulation protection to avoid perturbations due to external heat sources or sinks.
- Global Solar Irradiance: Pyranometer, model CM11 manufactured by Kipp and Zonen, secondary standard according ISO 9060:1990, voltage output is directly measured using a differential connection.
- Longwave radiation: Pyrgeometer, model CGR4 manufactured by Kipp and Zonen, voltage output is directly measured using a differential connection. It incorporates a PT100 sensor to measure housing temperature which is directly measured using a four-wire connection.
- Outdoors relative humidity: model 41382 manufactured by Young, accuracy  $\pm 1\%$  at  $23^{\circ}\text{C}$ . This kit includes a radiation shield PT100 temperature sensor. Voltage outputs are directly measured using differential connections. Current output can be alternatively used.
- Wind sensor: Model Windsonic, manufactured by GILL INSTRUMENTS LTD. WindSonic is a 2-axis ultrasonic wind sensor, providing wind speed and direction data via two analogue outputs, with accuracy  $\pm 2\%$  in wind speed and  $\pm 3^{\circ}$  in wind direction. 4..20mA outputs are directly measured.
- Indoor relative humidity: model HMW60U manufactured by VAISALA, accuracy  $\pm 2\%$ , 4..20mA output directly measured.

- CO<sub>2</sub> concentration: Carbon dioxide transmitter model GMW115 manufactured by VAISALA, accuracy  $\pm(2\%$  of range  $+2\%$  of reading) , 4..20mA output directly measured.
- Heat flux density: Sensor model HFP01 manufactured by Hukseflux, accuracy of sensitivity coefficient 5%, voltage output measured directly by differential connection. Using signal conversion to 4..20mA, if the distance is too long.
- Water flow rate: Flowmeter model DVZ manufactured by Kobold, Accuracy:  $\pm 2.5\%$  of range, 4..20mA output directly measured.
- Electric power consumption: Vatimeter model SINEAX DME 440 manufactured by Camille Bauer, class 0.25 to IEC 688:1992, 4.20mA output directly measured.
- Detecting if doors and windows are “closed” or “not closed”: Mechanical magnetic switches for detection on/off.

Data are recorded every minute, although other recording intervals are available.

### Analysis of the data

The experimental set up has been designed and implemented with the aim to fit different objectives in the analysis phase. The analysis approaches applied are summarised in the following.

**Preliminary data analysis:** The first steps in data analysis consisted in data overview assisted by graphs to check quality, plausibility and consistency of measurements, as well as other preliminary analyses to check the degree of accomplishment of the initial hypothesis.

This phase included a climate study for the analysis of the representativeness of the monitored years regarding the typical year of each location, and if significant deviations are observed discussing in which sense these deviations can affect the energy performance of the buildings.

Also the representativeness of the offices previously selected for detailed monitoring has been verified using principal component analysis.

**Thermal performance analysis:** In previous works in this area very simplified components (simple walls) were chosen to study capabilities and limitations and illustrate the application of different analysis approaches from the simplest to other more sophisticated and accurate. In that previous work the focus was in the methods themselves so that the case study was simplified as much as possible.

The same analysis strategy, bottom-up increasing the degree of complexity and accuracy, is being applied to very complex rooms in occupancy conditions, aiming to understand and identify the main effects that are necessary to take into account in the energy balance in this room and how these effects can be simplified.

A regression analysis method based in averages has been used in a first approach to spot the main contributions to the energy balance in the rooms. Although the used equation is analogous to the one used in true steady state conditions, dynamic features of the test have been taken into account. A dynamic energy balance equation is first considered and then this equation is integrated for a time interval long enough to make the accumulation term much lower than the other terms. Finally averages are used to estimate integrals. The minimum integration period that allows this simplification has been identified. The main drawback of this method is that an excessively long test period is required to obtain reliable parameter estimates.

Further work will apply dynamic approaches that drastically reduce the required test period. This first analysis has given very useful criteria to select the main contribution to the energy balance equation that will be used in further dynamic approaches. Also the obtained parameters have provided with a very useful support for the validation of this future work.

**Simulation model validation and calibration:** Preliminary studies to assess discrepancies between theoretical and experimental evaluation have been performed. The adequacy of the available variables and experiment set up for model validation has been checked in the free running mode for the C-Ddl PSA. Effective models for predictive control purposes have also been obtained for the same building.

**Comfort analysis:** Comfort analysis for winter and summer has been carried out for those rooms identified as representative. This analysis that was based on the method of Fanger has been applied to all C-Ddl's.

## EXAMPLES OF PREVIOUS STUDIES

These test facilities were built and equipped in the framework of the PSE-ARFRISOL project (2005-2012), and till now all the studies carried out correspond to this project. Three types of results can be distinguished as explained in the following.

The first type of results refers to the experimental evaluation of the C-Ddls themselves. These results confirmed the foreseen energy savings together with adequate comfort levels in periods when the buildings are in use. The characterization of the envelope indicates that the C-Ddls present high levels of insulation and very low solar gain coefficients for summer and significantly higher for winter, indicating that workmanship has not introduced parasite thermal bridges. It also indicates that solar control intended in the design phase has been achieved, avoiding overheating in summer and promoting passive heating in winter.

In addition there has been some progress in the improvement and development of measurement procedures and analysis of experimental data for the energy assessment of buildings.

Finally the C-Ddls equipped with full instrumentation, and continuously monitored, are valuable experimental facilities for research activities in the field of Energy Efficiency in Buildings, and particularly to those focusing in the aspects related to buildings in South European weather conditions. These C-Ddls are available as experimental support for future research projects.

## MAINTENANCE / COLLABORATION

### Personnel involved

The PSE-ARFRISOL project has included as participants different key elements in the Spanish building sector such as building industry companies, manufacturers of solar heating and cooling systems and photovoltaic modules, manufactures of absorption pumps to use together with solar collectors, installers of solar collectors and photovoltaic modules, companies designers of engineering of solar and photovoltaic installations, research institutions, and building owners and users. The research institutions involved in the project have been CIEMAT, University of Almería and University of Oviedo, which have been the teams mainly involved in the research aspects of the monitoring activities.

The CIEMAT has coordinated all the monitoring activities in this project and has conducted all its phases for the C-Ddls Ed70 located in Madrid and PSA located in Tabernas. These activities have been done in collaboration with other groups in the rest of the C-Ddl's (Almería, Asturias and Soria).

The experiment design, exploitation and analysis have been carried out by CIEMAT Energy Efficiency in Building R&D Unit. Wiring and sensors installations have been done by external companies based in the technical specifications given by CIEMAT.

The University of Almeria has done the SCADA (Supervisory Control And Data Acquisition) for the five C-Ddls of the project. It is a tailor made application developed in LabVIEW according to CIEMAT's technical specifications. Also they have carried out the comfort studies for the C-Ddl CIESOL in Almería, and have developed and implemented several research activities in the field of control to optimize the comfort and energy behavior of this building.

The University of Oviedo has given support to data verification, pre-processing and comfort studies focusing on the buildings in Asturias and Soria.

## International collaboration

These tests facilities belong to CIEMAT's set of facilities that are giving experimental support to the participation of CIEMAT in several international initiatives such as DYNASTEE network, IEA ECBCS programme, IEA SHC programme, etc.

## Link to other devices

The activities carried out by CIEMAT's Energy Efficiency in Building Unit are largely experimental, focusing in energy performance assessment of buildings, and building components.

In the field of full size outdoors tests, several facilities in different scales are available giving support to these activities. The office building prototypes described in this chapter are complemented by the LECE's Outdoor Laboratory at the Plataforma Solar de Almería (PSA). The LECE has several systems for studying actual-size construction systems experimentally under real weather conditions. These experimental systems are the PASLINK and other test cells, the Solar Chimney, and Monozone Building.

In addition, the LECE infrastructure is prepared for the integration of new experimental prototypes that can be incorporated according to the needs of the Group's future research projects.

An Experimental Evaporative Wind Tower Prototype, is also available at CIEMAT in Madrid, for experimental analysis of passive systems for thermal conditioning of urban spaces using different natural techniques such as evaporation, desiccation and ventilation. It consists in a wind tower with a ventilator in its top part, protected by a grid.

Equipment for experimental research Fluid Dynamics in Buildings, are also available at CIEMAT in Madrid which main element is a particle image velocimetry (PIV) system. This system allows to obtain fluid velocity field using tracer particles. The operating principle of a PIV system is based on measuring tracer particles velocity carried by the fluid by means of images. This system enables the study of fluid movement and performing calculations of the upward velocity of the air and air flow in buildings.



SCADA C-Ddl PSA: Main screen that shows instantaneous meteorological measurements



SCADA C-Ddl CIESOL. Screen that shows air temperature instantaneous measurements

## RELEVANT LITERATURE

### General literature about the test facility:

R. Enríquez. 2013. In Spanish. “*Evaluación Energética Experimental de Edificios en condiciones reales de uso mediante el Ajuste de Modelos de*



*Simulación con aplicaciones al Control Predictivo*". Ph. D Thesis carried out at CIEMAT and presented at Complutense University of Madrid.

R. Enríquez, M.J. Jiménez, M.R. Heras. 2012. Analysis of a solar office building at the South of Spain through simulation model calibration. *Energy procedia*. 30, pp. 580-589.

M.J. Jiménez, R. Enríquez, M.R. Heras. 2011. System identification applied to energy analysis in a bioclimatic office building in semidesertic weather in the south of Spain. Presented at DYNASTEE international workshop on Whole Building Testing, Evaluation and Modelling for Energy Assessment. 18-19 May 2011, Lyngby, Denmark.

M. J. Jiménez, R. Enríquez, R. Olmedo, N. Sánchez, M.R. Heras. 2010. In Spanish. "*Monitorización energética de los C-Ddls del PSE-ARFRISOL. Diseño experimental*". Presented at congress: "*I Congreso sobre Arquitectura Bioclimática y Frío Solar*". Roquetas de Mar, Almería, Spain. 23-26 March 2010. ISBN: 978-84-693-5141-3.

J.A. Ferre, M. Pasamontes, M.M. Castilla, D. Bravo, N Sánchez, M. Berenguel, M.J. Jiménez, M. Pérez. 2010. In Spanish. "*Desarrollo de un software para sistema de monitorización para edificios bioclimáticos en el marco del proyecto ARFRISOL*". Presented at congress: "*I Congreso sobre Arquitectura Bioclimática y Frío Solar*". Roquetas de Mar, Almería, Spain. 23-26 March 2010. ISBN: 978-84-693-5141-3.

<http://www.arfrisol.es/>; Last viewed 30<sup>th</sup> April 2013.

<http://www.gill.co.uk/>; Last viewed 30<sup>th</sup> April 2013.

<http://www.youngusa.com/>; Last viewed 30<sup>th</sup> April 2013.

<http://www.kippzonen.com/>; Last viewed 30<sup>th</sup> April 2013.

<http://www.VAISALA.com/en/Pages/default.aspx/>; Last viewed 30<sup>th</sup> April 2013.

<http://www.hukseflux.com/>; Last viewed 30<sup>th</sup> April 2013.

<http://www.ni.com/products/esa/>; Last viewed 30<sup>th</sup> April 2013.

## Literature on previous measuring campaigns:

L. Castillo, R. Enríquez, M.J. Jiménez, M.R. Heras. 2014. Dynamic integrated method based on regression and averages, applied to estimate the thermal parameters of a room in an occupied office building in Madrid. *Energy and Buildings*. 81, pp 337-362.

J. Arce, J. Xamán, G. Alvarez, M.J. Jiménez, R. Enríquez, M.R. Heras. 2013. A simulation of the thermal performance of a small solar chimney already installed in a building. *Journal of Solar Energy Engineering, Transactions of the ASME*. 135(1), art. no. 11005.

R. Enríquez, L. Zarzalejo, M.J. Jiménez, M.R. Heras. 2012. Ground reflectance estimation by means of horizontal and vertical radiation measurements. *Solar Energy*. 86(11), pp. 3216-3226.

J.D. Álvarez, J.L. Redondo, E. Camponogara, J. Normey-Rico, M. Berenguel, P.M. Ortigosa. 2013. Optimizing building comfort temperature regulation via model predictive control. *Energy and Buildings*, vol 57. pp. 361-372

M. Castilla, J.D. Álvarez, M.G. Ortega, M.R. Arahá, 2012, Neural network and polynomial approximated thermal comfort models for HVAC systems, *Building and Environment*, vol. 59, pp. 107-115.

M. Castilla, J.D. Alvarez, M. Berenguel, F. Rodríguez, J.L. Guzmán, M. Pérez. 2011. A comparison of thermal comfort predictive control strategies. *Energy and Buildings*, vol. 43, no. 10, pp. 2737-2746.

L. Castillo. 2011. In Spanish. “*Análisis de cargas por ocupación en un Contenedor-Demostrador de Investigación del proyecto ARFRISOL*”. Master thesis carried out at CIEMAT and presented at Almería University.

M.J. Jiménez, R. Enríquez, M.R. Heras. System identification applied to energy analysis in a bioclimatic office building in semidesertic weather in the south of Spain. Proceedings of the 3<sup>rd</sup> International Conference Palenc 2010 jointly organised with EPIC 2010 & 1st Cool Roofs Conference. Rhodes (Greece). 29 Sept.-1 Oct. 2010. ISBN: 978-960-6746-08-6.

S. Soutullo, R. Enríquez, M.J. Jiménez, M.R Heras. 2010. In Spanish. “*Análisis del confort térmico de un edificio de oficinas en Madrid*”. Presented at congress: “*I Congreso sobre Arquitectura Bioclimática y Frío Solar*”. Roquetas de Mar, Almería, Spain. 23-26 March 2010. ISBN: 978-84-693-5141-3.

M.R. Heras, M.J. Jiménez, M.J. San Isidro, L. F. Zarzalejo, M. Pérez. 2005. Energetic Analysis of a Passive Solar Design, Incorporated in a Courtyard after Refurbishment, Using an Innovative Cover Component Based in a Sawtooth Roof Concept. *Solar Energy*, 78(1), pp. 85-96.

# KUBIK BY TECNALIA



## GENERAL DESCRIPTION

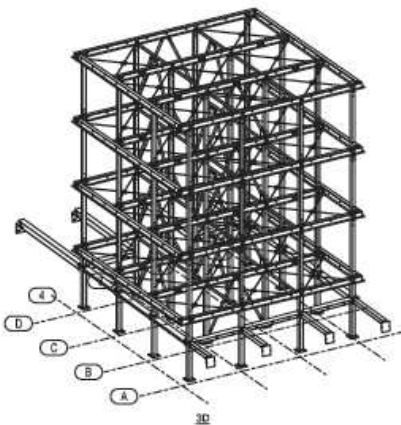

### Main objective of the test facility

KUBIK is aimed to the development of new concepts, products and services to improve the energy efficiency of buildings.

### Overall lay-out

The R&D infrastructure consists of a building able to provide up to 500 m<sup>2</sup> distributed in an underground floor, a ground floor and up to two storeys;

Institute/organisation:



FUNDACIÓN TECNALIA RESEARCH & INOVATION  
Construction Business Unit



Contact person:

José María Campos  
Inés Apraiz

c/Geldo - Parque tecnológico de Bizkaia - Edificio 700  
E48160 - Derio (Bizkaia)

tel: +34.946.430.069  
e-mail : ines.apraiz@tecnalia.com  
e-mail : josem.campos@tecnalia.com

**Exact location:**

Derio (Bizkaia), Spain

43.29° N, -2.87° E



Picture of the building with no elements in the façade (with no configuration)

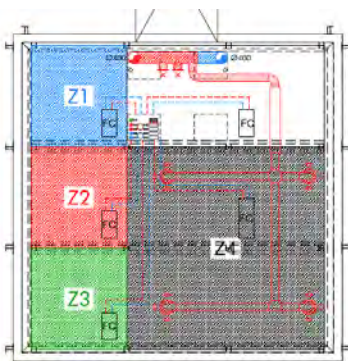

Measurement areas in each one of the storeys for evaluation the energy performance of the elements under realistic conditions

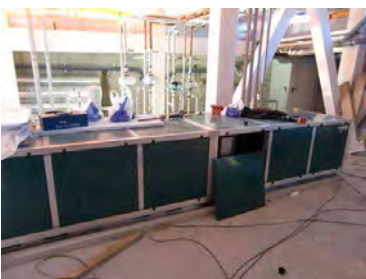

Thermal generation for its distribution in the measurement areas

the main dimensions are 10,00 m. width x 10,00 m. length x 10,00 meter high (plus and underground floor 3,00 m. depth).

The supply of energy is based on the combination of conventional and renewable energy (geothermic, solar and wind). In addition, the building is equipped with a monitoring and control system which provides the necessary information for the R&D activities.

### Inside boundary conditions

KUBIK enables the evaluation of energy performance, acoustic performance and air tightness evaluation of the scenarios built, see Fig. 2, taking into account the holistic interaction of the constructive solution for the envelope, the intelligent management of the climatization and lighting systems and the supply from non-renewable and renewable energy sources.

The main aim of KUBIK is to provide a better understanding of the performance at room or at building level, acknowledging the traditional laboratories as the better for the characterisation at component level according international agreed standards.

Scenarios	Ground Floor	First Floor	Second Floor
Available simultaneously, independent climatization zones			
Current layout off scenarios			

**Legend:**

N1, 2, 3: Northern rooms

M1, 2, 3: Middle rooms

S1, 2, 3: Southern rooms

Acústica 1, 2: Rooms equipped for acoustic research.

- R insulated
- VIP insulated
- Ventilated thermal zone
- Unventilated Thermal zone

Figure 1: Plan views showing the available layouts with independent HVAC systems

KUBIK has an advanced monitoring system, equipped with over 800 sensors that records conditions inside and outside the experimental facility, climatic conditions. Researchers and customers have access via the Internet to measurements being taken in the scenarios where the performance of the products and systems under development are evaluated. In addition, the monitoring system is integrated into an Intelligent Energy Management System which optimises the energy consumption of the building. The experimentally-

obtained results enable diagnoses and proposals for potential product improvements to be made.

## Outside boundary conditions

The surrounding area of the facility is fully open to all meteorological conditions, not being affected by any surrounding element. A detailed analysis of solar shadings produced by all surrounding elements like trees and streetlights was performed, and lead to the conclusion of some trees being transplanted to avoid any effects to the building.

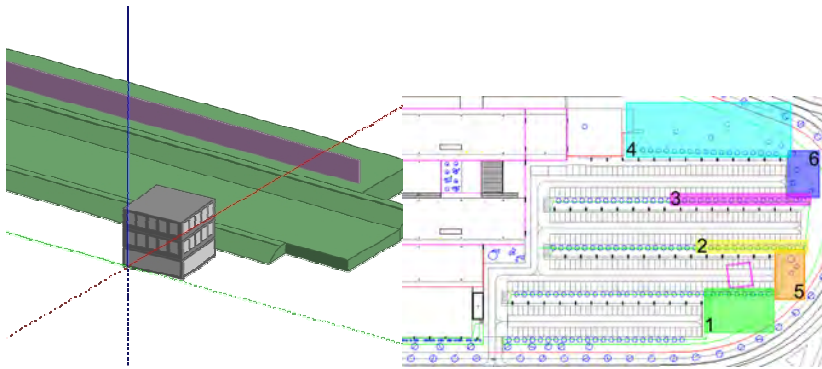

Figure 2: Left, model of the building and surrounding elements. Right, identification of each element with potential shading effect on the building.

## Special limitations / possibilities

Thanks to its flexibility, KUBIK can integrate all type of elements that are commonly used in construction. By elements are considered not only architectural solutions (curtain wall, prefabricated façade elements,...) but also thermal generation and storage equipments (thermal energy storage solutions, solar cooling equipment,...), electricity generation and storage solutions (BIPV elements,...) as well as any BIMS and/or building automation concept. All these solutions can be analyzed and improved under the realistic testing conditions of KUBIK, thanks to the monitoring and data system.

# DATA ANALYSIS

## Typical equipment within test wall

The infrastructure has up to seven individual measurement rooms; one control room and one service room per each of the three floors, see Fig. 3. It provides the possibility to combine some individual rooms into a unique measurement room if it is required by the experiment it and also allows to have all the three floors as a unique building, for example an specific office, school, etc..... This flexibility is possible thanks to the structural design and to the



Prefabricated concrete façade element, developed with Norten-pH

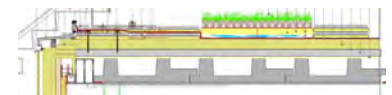

Green roof in Kubik, developed with Intemper, S.A.



Wooden façade element, developed together with Biohaus Goierri, S.L.



PV-Curtain wall developed by TECNALIA

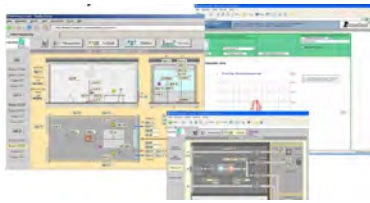

Measurement software, developed with Fraunhofer-IBP

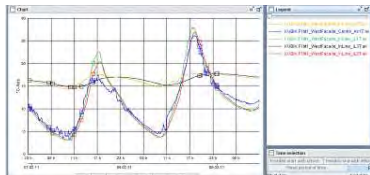

Data management system of KUBIK



Sensors in the roof of KUBIK

services design: each individual measurement room has the HVAC, power and data network that needs to build a scenario.

Figure 3 shows the nine rooms of each floor with the electrical and data network: the individual measurement rooms are: N1, M1, M2, M3, S1, S2 and S3; the control room is N3 and the service room is N2. Figure 1.f also shows an example of a possible layout of one floor: three individual measurement rooms (N1, M1 and S1) and one combined measurement room (a combination of M2, M3, S2, and S3) and their respective HVAC system.

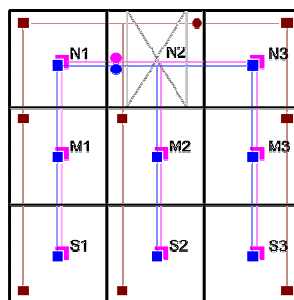

Captions:

- Blue boxes: sensor at floor level
- Pink boxes: sensor at ceiling level
- Brown boxes: power electricity

Figure 3: Equipment by each individual measurement rooms.

The monitoring system is in charge of data gathering and management tasks and to provide comprehensive information necessary for the analysis along. It collects data from the: measurement system; building automation system, HVAC control system and external meteorological conditions.

The monitoring system is equipped with over 800 sensors that records conditions inside and outside, weather conditions, the experimental facility. Researchers have access via the Internet to measurements being taken. The test measurement system includes the following sensors: indoor air temperature, surface temperature, radiant temperature, humidity, air velocity, heat flux, solar irradiance, luminance, CO2 concentration,...

### Accuracy and logging resolution

Some of the sensors installed in KUBIK are described:

Sensors				Measurement devices		
Sensor	Manufacturer	Type	Accuracy	Manufacturer	Type	Accuracy
Surface Temperature	Thermo Sensor GmbH	PT100 2113-1-072 2113-1-073 2153-1-891	± 0,1 °C	Beckhoff	EL3202-0010	± ± 0.1 °C
Air Temperature	Thermo Sensor GmbH	PT100 2113-1-074	± 0,1 °C	Beckhoff	EL3202-0010	± ± 0.1 °C
Solar radiation	Kipp & Zonen	CMP-6	±5%	Beckhoff	EL3602-0010	± ± 0.1 of FSV
Heatflux sensor	Phymas GbR	Type 7	±5%	Beckhoff	EL3602-0010	± ± 0.1 of FSV
Relative humidity sensor	Galltec Mess-und Regeltechnik GmbH	FPC 1/5	±2% rh (5...95 % rh at 10..40°C)	Beckhoff	EL3064	± ± 0.1 of FSV
Lux meter sensor	Czibula & Grundmann GmbH	091206	cosine error f2 < 1,5 %	Beckhoff	EL3064	± ± 0.1 of FSV

## Analysis of the data

The chosen measuring and management system is based on a PLC platform with Windows Embedded technology allows simultaneous scenarios analysis as well as with different requirements, boundary conditions.... The PLC layer of the control system is in charge of gathering data from the sensors and writing commands into the remote actuators, not only this but the PLC layer processes update the central database with the sensor and actuator values.

# MAINTENANCE / COLLABORATION

## Personnel involved

There are 4 persons dedicated to the facility, one mechanical engineer for the HVAC system, one telecommunication engineer for the monitoring, one physics as scientific coordinator and one professional for providing support.

## International collaboration

TECNALIA and IBP-Fraunhofer have collaborated in the development of Kubik, taking the VERU facility located in Holzkirchen (Bayern-Germany) as previous experience.

TECNALIA has initiated the European-funded project RIEEB (Research Infrastructure on Energy Efficiency in Buildings) to assess the impact of creating a European Network of Experimental Buildings / Research Infrastructures on Energy Efficiency.

## Link to other devices

KUBIK is connected to the MicroGrid facility located in the main building of the Sustainable Development Division. The Microgrid is connected to several sources of energy like a wind mill, solar PV panels, Hydrogen cell, electricity storage solutions, etc.



Figure 4: Micro Grid (part of DerLab) installed in TECNALIA-Sustainable Division



Air tightness test being performed in a measurement room in KUBIK



Radiation and temperature sensors on a measurement room in KUBIK

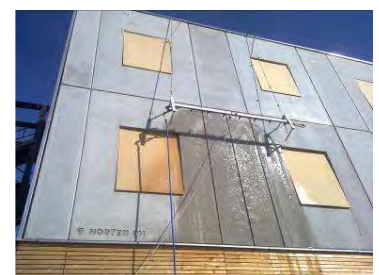

Water tightness analysis of the prefabricated concrete façade element

## RELEVANT LITERATURE

### General literature about the test facility:

**Kubik, una infraestructura singular para la eficiencia energética en edificación**, EnergíaBerria, energía del cluster de energía del País Vasco. Agosto 2009. Ed. Cluster de Energía. BI-2650-99

**KUBIK: Open Building approach for the construction of an unique experimental facility aimed to improve energy efficiency in buildings**, Proceedings of the O&SB2010 "Open and Sustainable Building", ISBN: 978-84-88734-06-8

**KUBIK by TECNALIA, I+D+I sobre eficiencia energética en edificación** Revista DYNA Ingeniería e Industria, 2011 ISSN: 0012-7361



Southern façade of KUBIK



Northern façade of KUBIK



Eastern façade of KUBIK



KUBIK



# SALFORD ENERGY HOUSE



## GENERAL DESCRIPTION

### Main objective of the test facility

The test facility (Energy House) has been designed and developed to allow leading academics and researchers to conduct test and experiments, to improve the energy efficiency of “hard to treat” properties. This includes the development and testing of new materials, systems and products as well as looking at behaviour change associated with the adoption of energy efficiency measures in the home.

A unique testing asset, the Energy House is the only full-scale building in an environmental chamber in Europe and the only full-scale, brick-built test facility in a controlled environment in the world. The Energy House is also breaking new ground in terms of Building Physics, carrying out many verification tests for methodologies that are currently used (and being

### Institute/organisation:

University of  
**Salford**  
MANCHESTER

University of Salford

### Contact person:

Richard Fitton  
Lead Researcher  
Energy House  
Cockcroft Building  
Salford M5 4WT  
UK  
+44(0)161 295 6801

[r.fitton@salford.ac.uk](mailto:r.fitton@salford.ac.uk)

### Exact location:

Salford  
Greater Manchester



Salford Energy House in a fully environmentally controllable chamber.

developed) to test the energy performance of buildings and address the gap between design and as-built performance.

### Overall lay-out

The house is a traditionally constructed, terraced building (with a neighbouring property). It has solid brick walls, suspended timber floors, lath and plaster ceilings and single glazed windows. In its current state it is uninsulated. The heating is provided by a wet central heating system, fired by a gas condensing combination boiler. All of this can be changed to suit the testing requirements.

### Inside boundary conditions

The house, is a fully functional / liveable house, and includes fully fitted kitchen (with all appliances) fully fitted and functional bathroom. To start with the Energy House has been fitted with a condensing boiler for heating and hot water, which can and will be changed to allow different heating systems etc to be developed and tested. The Energy House can accommodate voltage optimisation systems as well as a variable voltage main that allows for the development and testing of a low energy house. An adjacent property (1/3<sup>rd</sup>) of a house has also been created to allow test to be conducted on the party / adjoining wall between the two properties.



The Energy House and its adjacent conditioning void, used to control and monitor energy loss and heat transfer through party walls.

### Chamber Environment

The external environment surrounding a dwelling can potentially make a significant difference to how much energy is required to heat the building. It is for this reason that we have developed the chamber to recreate a series of external weather conditions:

- Rain (up to 200mm each hour)
- Temperature ranges from -12C to +30C (with an accuracy of +/- 0.5C)
- Wind (localised and chamber wide) up to 10 m/s
- Snow.

### Special limitations / possibilities

The Energy House is a very flexible facility is suitable for all manner of testing, the only limitation, is that it must be restored to its original state following any measures.

Since opening, the following funded testing has taken place:

- Performance of building controls (TRV and thermostats)
- Performance of insulation solutions (of all kinds)
- Testing of various building performance tests (Coheating, in-situ U value monitoring etc.)
- Door and window heat loss testing
- Monitoring the performance of electrical heating systems.



A wide range of boundary conditions can be placed on the structure including wind and rain

## DATA ANALYSIS

### Typical equipment within testing setup

The test facility uses several different monitoring equipment, all logging and displayed through a custom time series program. This provides live data feeds and real time analysis of the following data points. Currently the Energy House has a large number of sensors which are able to read down to 1 second resolution. This can generate over 2.8 Gigabytes in a week long test.

A typical setup for an experiment is given below:

Measurement	Locations	Number of Sensors
Air temperatures	Each corner of each room at three different heights, centrally in each in each room, floor void and roof void	89
Relative humidity	Centrally in each room, floor void and roof void	7
Chamber air temperatures and relative humidities	Side, front and rear	3
Heat meters (Measuring energy output)	On each radiator and complete flow and return circuit	7
External thermal imaging	Side, front and rear	3
Electricity consumption and power	Mains incoming, individual circuits and individual appliances	25
Gas consumption	Taken from main using MID meter and counter	1
Heat flux	Each external element (walls, floor and roof)	Approximately 25
Boiler performance	Flue temperature, flow and return temperature and rates and pipe temperatures.	8

The chamber itself has thermal and CCTV cameras which are continually monitoring the building.

The Energy House is an exceptionally flexible test facility and the monitoring system reflects this, accepting many different types and configurations of sensors, as such no test setup is the quite as the last.



The fully functioning kitchen.



Fully functioning living room.



One of the fully functioning bedrooms.

## Analysis of the data

All of the building performance information is fed through a wired network to a server. From here the data is collected and analysed using a custom piece of software. This can then be accessed by researchers either working on the campus, or over the internet via a web page.

Real time analysis and calculation can also be carried out, this aids the prediction of thermal constants, and helps predict when steady state conditions will occur as part of an experiment.

# EXAMPLES OF PREVIOUS STUDIES

## **Saint-Gobain - Whole House Retrofit**

Over a period of three months, Saint-Gobain worked closely with Salford University, Leeds Metropolitan University and Saint-Gobain Recherche on what is believed to be the most in-depth study into whole house retrofit.

The objective of this phase of testing was to carry out a full retrofit of the building, but in a way that allowed stage by stage savings to be visible, in terms of performance changes in whole house heat loss and air permeability. This was to be carried out under closely controlled and observed conditions.

Saint-Gobain and the project team were delighted to find that the whole-house results were as calculated and the Saint-Gobain systems installed, in combination, reduced the heating demand of the property by 63%. Taking an average gas fuel price for Manchester in 2012, this house could be heated for less than £4 per week - a saving of almost £350 per year to the energy costs of a small dwelling. The CO<sub>2</sub> saving of 1.45 tonnes pa is equally important in contributing to climate change targets. It was also notable that a 50% reduction in air-leakage resulted from the interventions made and this, in combination with the thermal improvements, resulted in a more comfortable internal environment where more of the house could be used with no impact on energy costs, showing the value in a whole-house, holistic approach to retrofit.

## **Comprehensive Study on the In-situ Performance of Building Heating Controls Under Controlled Conditions.**

The BEAMA (British Electrotechnical and Allied Manufacturers' Association) Heating Controls Study project is designed to assess the impact of different heating control sets on the consumption of energy in heating a home. The study aimed to bridge the gap between laboratory-based work and fieldwork, neither of which fully recreate a real-life, yet controlled, environment.

## PART 2: Facilities for energy use analysis at whole building level

The study looked to assess the impact of three different types of control arrangements and how they affected energy consumption, internal room temperatures and system performance.

- Boiler thermostat only (no local controls)
- Boiler thermostat and living room thermostat.
- Boiler thermostat, living room thermostat and thermostatic radiator valves (TRVs).

Results:

- Adding a thermostat to the heating system reduced the energy cost by 12%
- Adding both a thermostat and thermostatic radiator valve (TRV) reduced the energy cost by 40.7%

### St Gobain Research (Paris): Rapid building performance evaluation tool

The project involved an investigation and verification of a unique and patented test methodology known as the QUB method. This is designed to rapidly determine the energy performance of a dwelling. This test can be carried out in approximately 48 hours, which is currently quicker than all other similar methods. The project involved conducting a series of tests over a 6 week testing window using dynamic and steady state temperatures in the chamber. This work was published through the International Energy Agency in 2013 as a joint piece of research between the Energy House team and Saint Gobain Research.

### University College London: Development of U Value measurement for suspended timber floors

The measurement of heat loss through any floor is difficult to model and to measure. This is further complicated with a suspended floor as a varying amount of air passes through the void at any one time. In addition many junctions and both regular and irregular thermal bridges can occur (such as floor boards, joists and fixings).

A project was devised to carry out a high resolution study of heat transfer through the ground floor of the Energy House, under controlled and steady state conditions. This involved the use of over 25 heat flux transducers to measure and monitor heat loss through the ground floor. This led to what we believe to be the clearest data available worldwide for heat loss through a suspended floor under steady state, but real world, conditions.

### Leeds Metropolitan University: Whole house heat loss testing/co-heating

Leeds Metropolitan University is regarded as a leader in field-based energy performance monitoring, having developed a methodology for whole house heat loss measurement. This is widely cited and used by many building performance evaluators. Teams from Leeds and the University of Salford are currently working on verifying the methodology and developing it further using the Energy House as a test bed. This involves testing the methodology

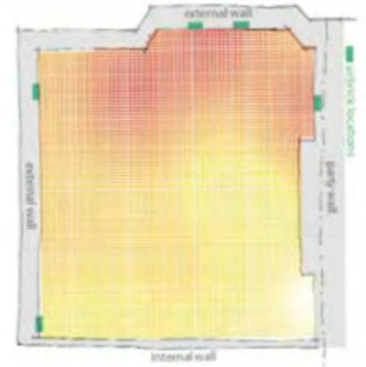

An example of a graphical representation of heat loss through the suspended floor.



The building following a deep retrofit project, illustrating the flexibility of the property

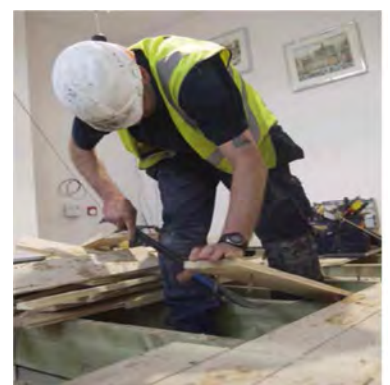

Work being carried out to insulate the floor of the Energy House prior to a trial

under steady state and dynamic chamber temperatures, as well as new novel methods of testing using systems already installed in a typical house.

## MAINTENANCE / COLLABORATION

### Personnel involved

As with all the testing and development facilities at the University, the Energy House is manned by fully trained and experienced technicians, who conduct the tests. This is supported by leading academic and researchers, from the Built Environment, Physics, Materials Science, Mechanical and Electrical Engineering. We have also partnered with Universities such as Leeds Metropolitan and University College London (UCL) on several academic research projects.

### International collaboration

The University is internationally recognised for its industrial collaborations, through a range of projects and programmes, including Knowledge Transfer Partnerships (KTPs), European Funded initiatives (for example Framework programmes), Traditional Consultancy and Collaborative Research and Development projects.

### Links to other Facilities

The house will be complemented by the University's existing state-of-the-art world leading facilities, including: -

- UKAS Accredited Thermal Test laboratory which will allow leading researchers and academics to work with organisations to develop and test new thermal and insulation products for the building / housing market, including solid wall insulation products
- UKAS Acoustics Laboratories that provide a unique facility that enables our researchers and academics to develop and test new sound insulation products for the building sector.
- Full analytical and material testing facilities, with core techniques that include Microscopy, NMR and X-Ray Diffraction.
- External Properties, which are used to monitor consumer behaviour within properties that have undergone retrofit schemes and those that haven't. This data is used to simulate everyday activity within the Energy House.

# FLEXLAB: Facility for Low Energy EXperiments in Buildings



## GENERAL DESCRIPTION

### Main objective of the test facility

FLEXLAB, the Facility for Low Energy EXperiments in Buildings, is a series of 5 full-scale test facilities, (1 indoors, 4 outdoors), a Virtual Design and Simulation Lab and a Sensors/Controls Lab; all fully operational in 2014. It will allow a wide range of users--building owners, architects/engineers, manufacturers, code officials, utilities and researchers - to explore all aspects of “performance” of integrated building systems, including façade/envelope, lighting, office equipment, HVAC and on-site power systems, under dynamic operating conditions, for periods of time ranging from days to months. Up to six spaces could be tested simultaneously, with or without occupants. It will be heavily instrumented, with an internet-based data acquisition and control system that can be accessed and operated remotely by research partners.



Environmental Energy Technologies  
Division  
Lawrence Berkeley National  
Laboratory  
Berkeley, CA USA

### Contact person:

Stephen Selkowitz  
Mailstop 90-3111  
LBNL  
Berkeley, CA 94720  
+1 510 486 5064  
seselkowitz@lbl.gov

### Exact location:

Berkeley, CA, USA  
37.86°N, 122.26°W

## Overall lay-out

Four testbeds are aligned outdoors in a row facing south. Three are 1-story structures with steel frame and heavily insulated “non-experimental” surfaces. Each is 12.2m wide and 9.2m deep but can be divided in half so that two 6.1m rooms are adjacent; each with independent HVAC. Height to underside of roof structure is about 4.6m and can accommodate a variable height drop ceiling. The westerly-most one-story testbed can be fully rotated on its foundation. A fifth testbed consists of two side by side 2-story spaces, each approximately 7.6m x 7.6m in footprint and 8m tall. These can be operated as a single two story space for thermal convection studies or high bay lighting studies or an intermediate floor can be added to create a two floor module. A large section of the roof is removable to accommodate skylights. The Lighting/Plug Load Testbed is located on the 4th floor of an existing building, consisting of two side by side experimental spaces totalling 370 m<sup>2</sup>. Each light fixture and each electrical outlet can be separately metered and controlled. The space with a total of 17 interior cubicles and 10 perimeter offices is fully occupied so all experiments are designed to address some aspect of occupancy.



Overall artist's view of completed facility, looking from Southwest

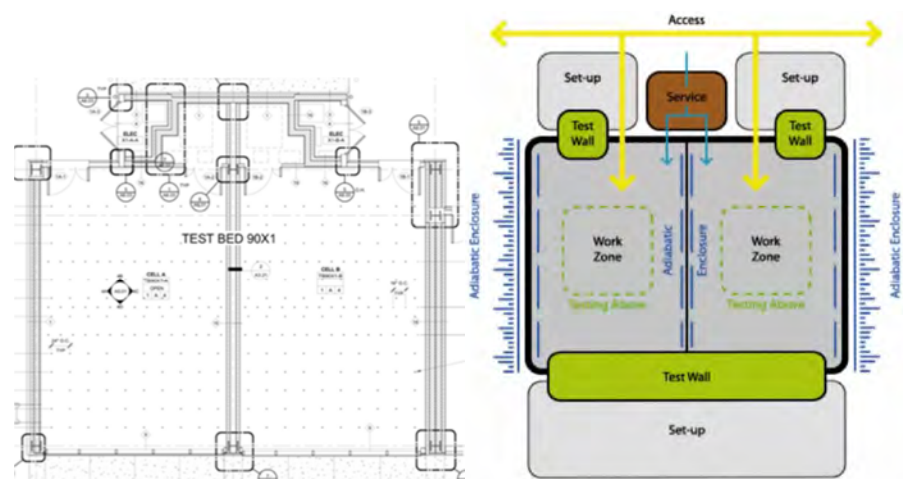

Single testbed diagram, showing option to split cell; left: design; right: concept



## PART 2: Facilities for energy use analysis at whole building level

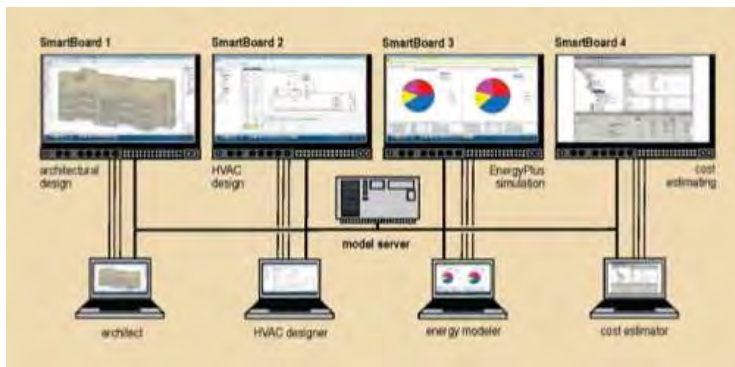

The Virtual Design and Visualization Lab, located in existing renovated space, has 4 networked computer workstations and 4 state-of-the-art large area “smartboard” displays for collaborative problem solving.

### Inside boundary conditions

Each half test cell has separate HVAC systems that can supply conditioned air or water to supply heating or cooling loads for any type of air-based or hydronic HVAC, including VAV, CAV, underfloor air, displacement ventilation, radiant slabs, radiant ceiling panels, chilled beam. The systems have capacity to operate indoor conditions outside normal comfort requirements to simulate more severe winter and summer test conditions

### Outside boundary conditions

The facility is located in Berkeley CA with a clear south and west exposures and generally good sunlight after some seasonal morning fog. Temperatures are not extreme although the facility operations can control indoor conditions to create a greater than typical temperature difference (indoor to outdoor) than would be normally experienced. Three outdoor facilities face south; cross ventilation is possible with front and back openings. The two story space has clear roof access for skylighting studies.

### Special limitations / possibilities

Each of the one-story facilities can be divided in half with an adiabatic wall to provide two direct side by side chambers (or 6 total). A key design feature is the flexibility to reconfigure all the key building systems: Envelope/façade, lighting, plug loads, and HVAC. For envelope/façade virtually any glazing,

shading, daylighting and spandrel panel technology can be utilized. For lighting all types of direct/indirect, ceiling mounted or furniture mounted systems, and any sources ( e.g. fluorescent, HID, LED, etc) and controls (scheduling, occupancy, tuning, daylighting) can be set up and tested.

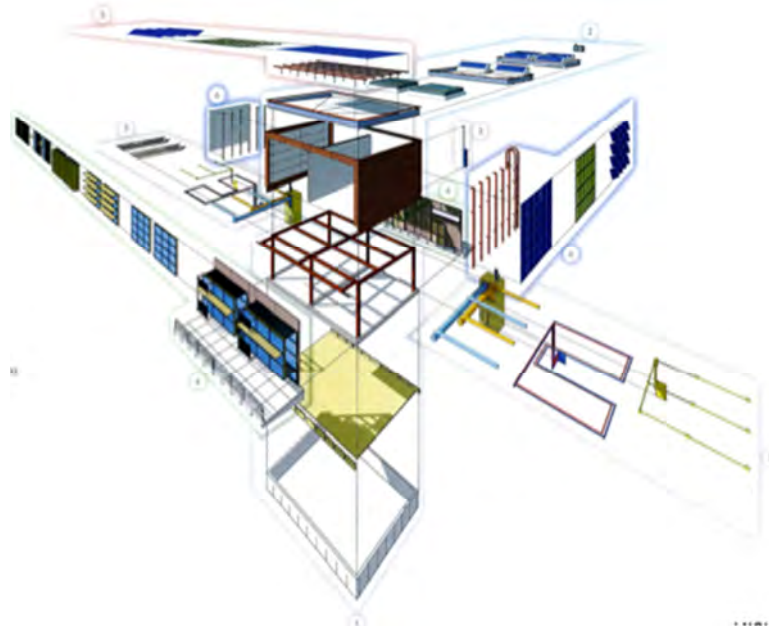

Figure showing conceptual view of reconfigurable building elements

## DATA ANALYSIS

### Equipment within test beds

The overall facility has over 500 measurement points initially and 100s more can be added for specific experimental needs. These include all the sensors and controls needed to operate the experimental apparatus, e.g. flow rates, temperatures, valve position, etc as well as the specialize instruments needed to measure parameters as part of the scientific research program, e.g. floor to ceiling stratified temperature profile or high dynamic range imaging of the surface luminances. The data acquisition and controls package is based on National Instruments Teststand which is widely used by researchers. It has custom adaptor packages to allow custom scripts and controls to be developed using simulation platforms and scripting languages interfaced with different controls and simulation software platforms. The entire system is internet based allowing either onsite or offsite access. All data is stored on a central secure database so that multiple competing manufacturers could share an experiment but protect their controls sequences and data. A weather station and real time video monitoring provides local weather site specific climate data.

## Accuracy and logging resolution

Many of the sensors and research instruments are being specified with measurement accuracy in the range of 1%, when feasible. The first year's operation has a calibration and assessment task that will identify more rigorously the actual experimental uncertainty in derived measurement quantities.

## Analysis of the data

Time series data is captured, cleaned and archived from all data channels. This will include video documentation as well as numerical data. The specific analytics will depend upon the nature of the research project being undertaken and the interests of the collaborators. In some cases we expect our industry partners will be more interested in a high level assessment of "how much energy was saved" whereas our interests will be to delve much deeper into the details of the measured data to extract more useful information. We are developing very detailed models of each of the test rooms using Modelica and EnergyPlus. These will be used to conduct and refine virtual experiments before the actual experiment is undertaken.



# EXAMPLES OF PREVIOUS STUDIES

LBNL had conducted extensive outdoor room tests over more than 25 years in several facilities. The first outdoor thermal tests were conducted in the MoWiTT (Mobile Window Thermal Test) Facility from 1985 to 2000. MoWiTT contains two highly instrumented calorimetric chambers that can accommodate windows approximately 2m x 2.5m and skylights approx. 1m x 1m. Because the facility was built as a trailer it can be trucked to different sites and tested under different climate conditions and rotated to face any direction. Numerous published results related to experimental methods, uncertainty and dynamic thermal performance of glazing, shading and daylighting systems for facades are available.



Beginning in 2004, new studies were undertaken of façade and daylighting systems in the newly built Advanced Façade Testbed. This facility has 3 side-

by-side rooms, with reconfigurable facades up to 3m x 4m, with associated shading, daylighting, lighting controls and interiors, with the primary interest in studying daylighting and shading design strategies. These rooms are normally tested as unoccupied spaces but can be occupied to test user reactions to the façade systems.

## MAINTENANCE / COLLABORATION

### Personnel involved

Detailed FLEXLAB facility operating plans are being developed. These include the safe operation of the facility as well as efficient operations needed to reduce operating costs. The facility will use LBNL staff who are already involved with and highly experienced in operation of other similar outdoor test facilities and on-site building measurements.

### International collaboration

As with our other “user” test facilities, we expect that FLEXLAB will be used by researchers globally, both directly and indirectly. The facility is constructed at LBNL with the expectations that others will have access to it, and this included international collaborators. Our existing facilities have been used by visiting researchers from many countries and they have also been used by LBNL researchers as part of our contributions to past IEA tasks. We believe FLEXLAB will make a strong contribution to the new work in IEA Annex 58.

### Link to other facilities and devices

FLEXLAB is part of a much larger set of dynamic building test facilities in operation at LBNL, which are mostly focussed on windows and facades. As described, above the new facility will allow us to extend results from other facilities to include more interactions with HVAC systems and other occupant impacts characteristic of larger shade shared spaces. It also links directly with other specialized facilities such as a large outdoor integrating sphere and the scanning goniophotometer. These devices measure properties of the complex systems; the new facilities like FLEXLAB then measure the energy impacts of those systems with measured properties.

Information is being developed as the facility is completed. See [flexlab.lbl.gov](http://flexlab.lbl.gov) to download current publications. Over 100 papers have been published on the lab and field measurements related to window and façade systems. These can be searched and downloaded at: <http://buildings.lbl.gov/publications>