

IEA Annex 61

'Development and Demonstration of Financial and Technical Concepts for **Deep Energy Retrofits** for Government/Public Buildings and Building Clusters'

Ideas out of the Passive House Development

Speaker: Berthold Kaufmann, Passivhaus Institut



passipedia

[article](#) | [discussion](#) | [recent changes](#)

Login

You are here: start

Welcome to Passipedia!

The Passive House resource

Welcome to Passipedia, the Passive House resource! Please note that this is a project under construction which has only just been launched and will continuously grow and evolve over the next few months. The following pages are little more than a preview of what's to come... Please take a first look and keep visiting in the future to watch Passipedia grow!

search

navigation

Structure:

- [Passipedia A-Z](#)
- [Basics](#)
 - [What is a Passive House?](#)
 - [The Passive House - definition](#)
 - [The Passive House - historical review](#)
 - [Energy and ecology](#)
 - [Efficiency vs. performance](#)
 - [Energy efficiency - the key to future energy supply](#)
 - [Summer](#)
 - [Internal heat capacity](#)
 - [Building physics - basics](#)
 - [Affordability](#)
 - [Passive Houses in different climates](#)
- [Planning](#)
 - [Calculating energy efficiency](#)
 - [Thermal protection](#)
 - [Airtight construction](#)
 - [Building services](#)
 - [Refurbishment with Passive House components](#)
- [Operation](#)
 - [Operation and Experience](#)
- [Examples](#)
 - [Residential buildings](#)
 - [Non-residential](#)

What is a Passive House?

A building standard that is truly **energy efficient, comfortable, affordable** and **ecological** at the same time. Passive House is not a **brand name**, but a **construction concept** that can be applied by anyone and that has stood the test of practice.

Please click here to view [Passive House examples](#). Passive House components have also proven effective in [existing buildings](#).

Passive Houses offer:

- an energy savings of up to 90 % compared with existing buildings and more than 75 % compared with average new buildings. In terms of heating oil a Passive House uses as little as 1.5 litres per square metre per year – far less than a low-energy building.
- a higher level of comfort! Superior air quality and pleasant temperatures year round.
- a Passive House makes use of energy sources within the building, such as the residents' body heat or the sun entering the building, making heating so much easier.

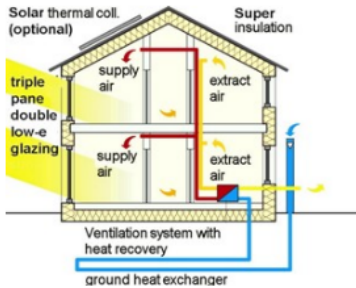

The Passive House – the leading concept for:

- [Insulation](#)
- [Thermal bridge free design](#)
- [Airtight construction](#)
- [Heat recovery ventilation](#)
- [Highly insulating windows](#)
- [Innovative building services](#)

An energy balance is compiled to make sure that all these details are perfectly coordinated. This balance is established using the [Passive House Planning Package \(PHPP\)](#).

[--> read more!](#)

Topics & News

Topics - Overview

<p>Basics</p> <p>Building physics, comfort, costs, sustainability</p>	<p>Planning</p> <p>Information relating to the planning phase</p>
<p>Construction</p> <p>Quality assurance during construction</p>	<p>Operation</p> <p>Recommendations, user experience, measurement results</p>
<p>Examples</p> <p>Built examples</p>	<p>Certification</p> <p>Certification for houses, components and designers</p>
<p>Education & training</p> <p>University programmes, seminars, training courses etc.</p>	<p>Experiences</p> <p>Awareness, connectivity, politics etc.</p>

The latest news & developments:

Follow IPHA on

[IPHA - events](#): Click here to get information on current events put on by IPHA members: trade fairs, seminars, work shops, conferences, briefings...

Visit the [Passive House Institute website](#) to learn about the latest scientific findings

Upcoming events:

12 - 14 November 2010: 7th International Passive House Days - Experience the Passive House for yourself! 

10 December 2010: The 42nd session of the Research Group for Cost-efficient Passive Houses will

www.passipedia.org

- recently high energy prices...
- **for deep renovation just copy Passive House**
- full lifecycle costs evaluation gives extra budget options:
 - extra investment on building envelope
 - significantly lower energy consumption costs
- both effects balance each other! (at present energy prices)
- **! if savings are significant ! much more than 50% possible !**

- recent examples for good practice to be input to Annex 61:
IEA Task 28 (newbuilt) IEA Task 37 (renovation)
...
- the 'three risk' evaluation – what do you fear about?
 - risk of failure 1 ... nobody needs that building here
 - risk of too high construction costs / interest rates
 - risk of too low energy prices ... too low calculated cost savings
 - risk of failure 2 too bad quality, so not enough savings

recently high energy prices...

- economic numbers clearly show what to do ('deep renovation')

why do so few actors really do?

possible approaches how to solve this dilemma:

- **which actions (renovation) give what savings?**
detailed energy balance calculation needed
- **important question (technical): do buildings work as intended???**
Quality Control is crucial
make good quality visible by labelling
- **important question (economical): is there a budget????**
economic balance evaluation is crucial
economic evaluation (total lifecycle) of energy efficiency actions
- ((cost effective passive houses: a concept for social housing))

evident things...

you should only do build things you really need

– if you do not need a building (or have no money) don't do it.

- energy savings (EE) repay for the energy related action investment but for nothing else

look out for chances – combine the business

- if there is a building/renovation needed anyway just do the related energy saving action in that moment
- extra costs for thermal insulation etc. are quite small

recently energy prices high ... interest rates low:

- investment in EE has priority to energy consumption

economic numbers clearly show what to do ('deep renovation')

Examples for Passive Houses at some selected locations in Europe

- thermal insulation helps in anyway
- U-values might be lower, but not in the roof!

	Mannheim	Toledo		Seville	Palermo
		roof always well insulated			floor slab not insulated
		TO	MA	Sev	Pal
Insulation wall [cm]	25	20	10	8	6
Insulation roof [cm]	35	25	25	20	20
Insulation basement [cm]	20	15	6	0	0
U window frames [W/(m ² K)]	0.72	0.72	0.72		
U-value glazing [W/(m ² K)]	0.7	1.2	1.2		
Humidity control for cooling	no	yes	no	no	yes
Heating demand [kWh/(m ² a)]	15.6	14.8	12.7	4.6	3.1
Sensible cooling [kWh/(m ² a)]	0	0.8	0.4	4.2	7.2
Latent cooling [kWh/(m ² a)]	0	2.3	0	0	7.2

insulated frame & double low-e glazing for thermal comfort

construction determined by winter conditions

significant cooling required

Less frame insulation

for more information see www.passipedia.org

if active cooling needed – no more cooling peak power problem in PH

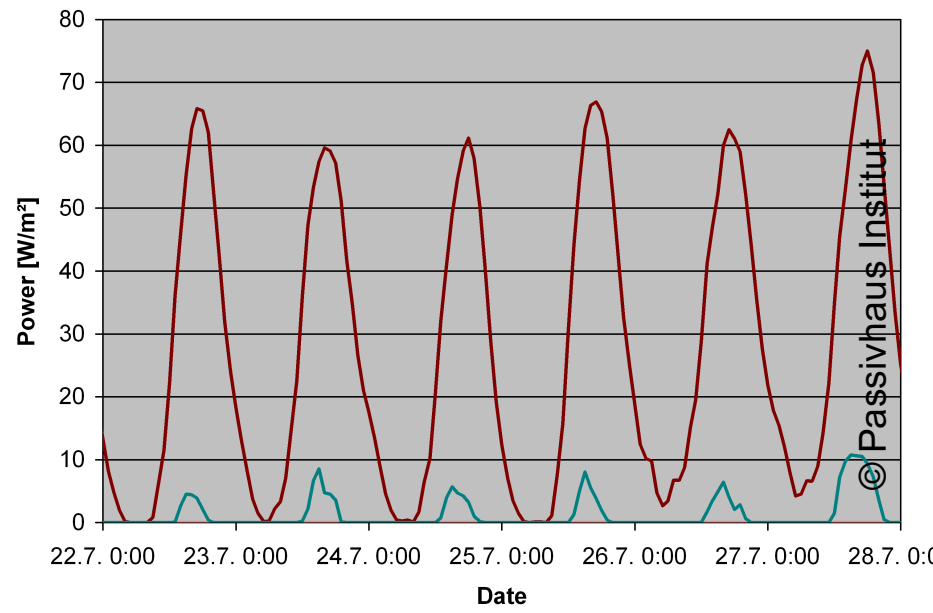

Existing old standard building:
needs very high cooling power

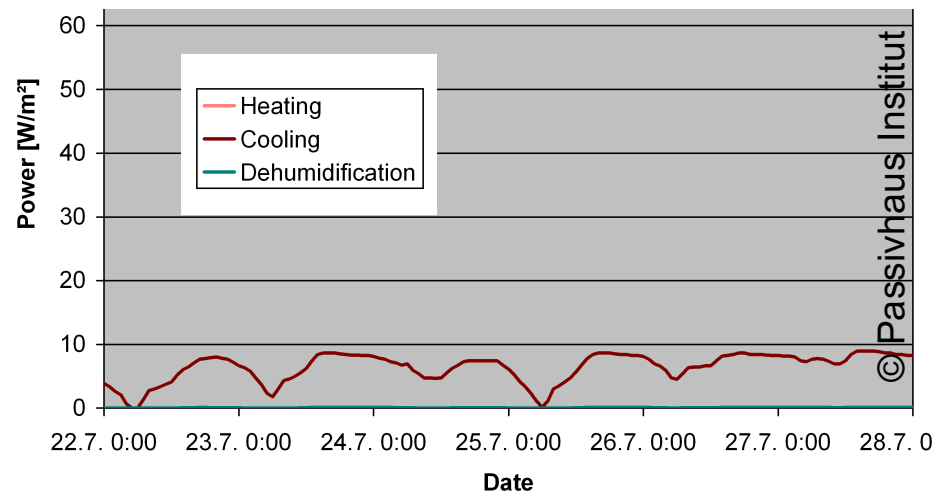

Passive House:
only low cooling power needed
no electric peak power problem

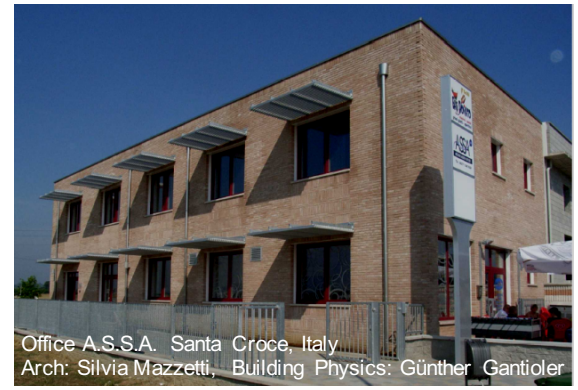

for more information see www.passipedia.org

how to design buildings with respect to energy – setup detailed energy balance

- Going to small numbers you must be exact!
- new PHPP version 8.2 (2013) available
- ... extended ventilation spreadsheet for office buildings
- ... sheets 'summer', 'cooling', 'dehumidificatio' revised
- ... access to further climate data sets possible

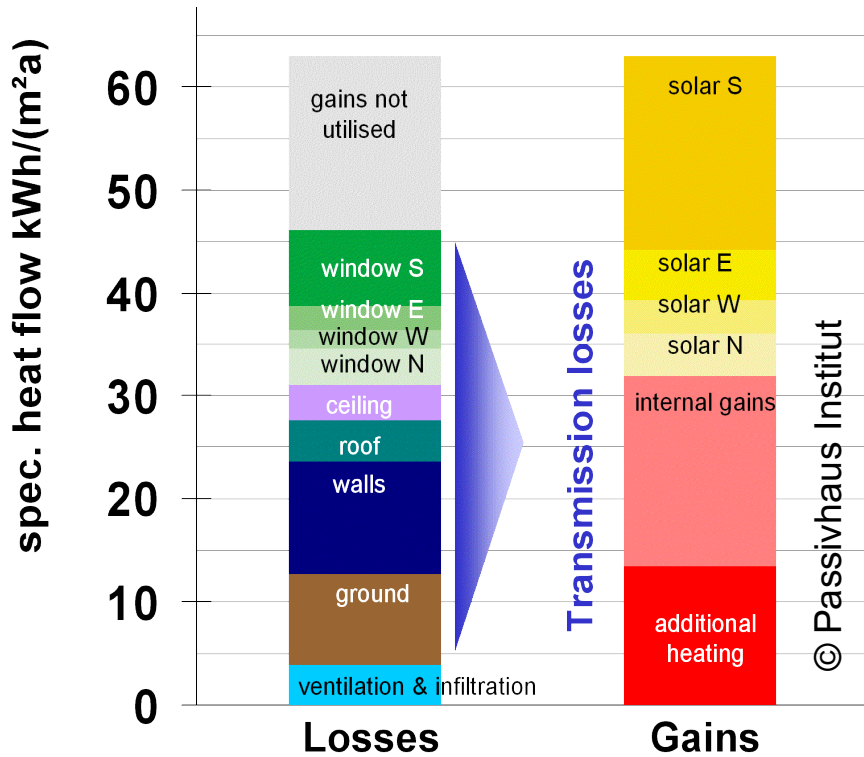

QA and QC with deep energy retrofit

Quality Assessment & Quality Control by third party

is absolutely necessary

is worth while (because not really expensive)

- thermal insulation (U-values)
- thermal leakage (thermal bridges)
- air tightness of building envelope
- heat recovery performance of ventilation system

When having checked ... mark 'good quality' by labels

- labelling is helpful for visualisation
- labelling is market information
- labelling provides orientation of market players

We know about good quality and can help to get it!

but there is no guarantee... anyway – good chance to win!

Buildings
(new & renovation):



Components:

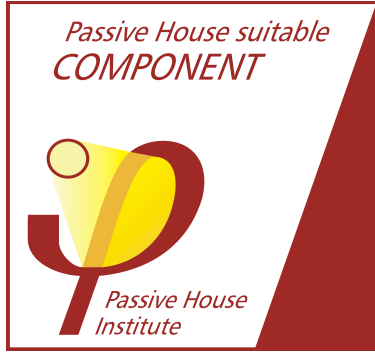

certified window frames and glazings, doors, ventilation systems compact heat pump units, construction systems without thermal bridges, low thermal bridge solutions,...

Persons:



windows and window frames for Passive Houses: examples

- the recommended trend: slim frames to get maximum input
- low U-values to further reduce thermal losses
- low costs...

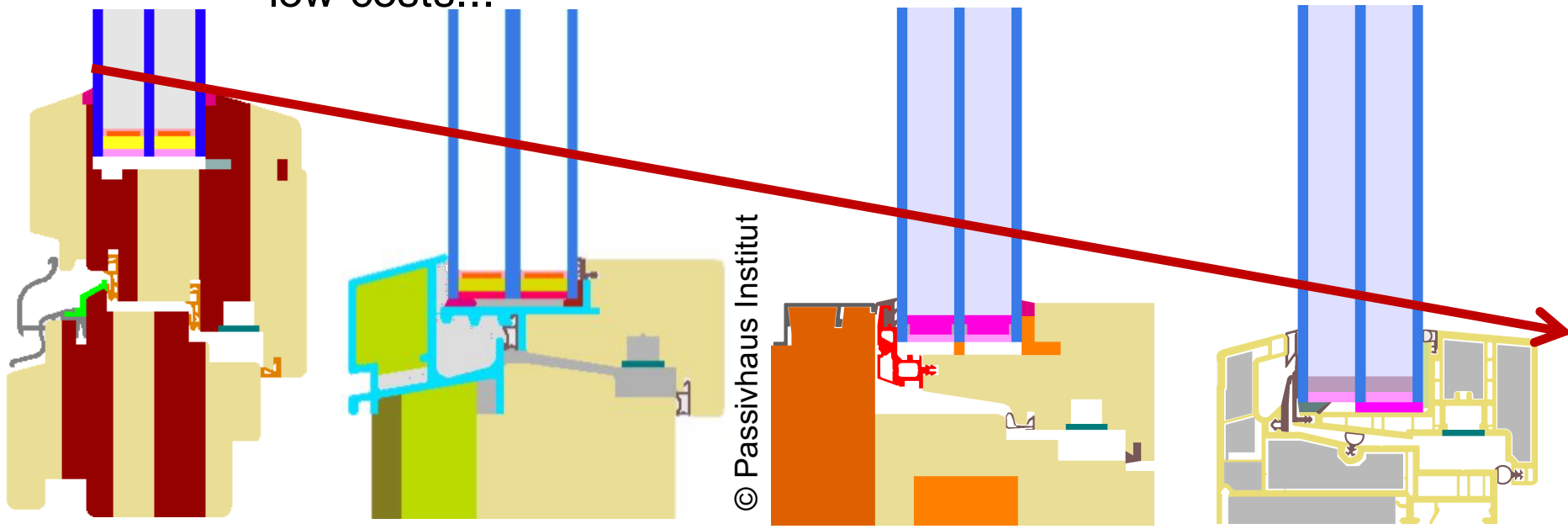

© Passivhaus Institut

Winter ewitherm
 bf: 154/169 mm
 U_w : 0,77 W/(m²K)
 Ψ_{opak} : 0,170 W/(mK)
 Efficiency class: **phC**

Pazen ENERsign
 bf: 100 mm
 U_w : 0,68 W/(m²K)
 Ψ_{opak} : 0,106 W/(mK)
 Efficiency class : **phA**

ProPh-F. SmartWin
 bf: 87 mm
 U_w : 0,79 W/(m²K)
 Ψ_{opak} : 0,098 W/(mK)
 Efficiency class : **phA**

FBS Over: VADBplus
 bf: 75/100 mm
 U_w : 0,74 W/(m²K)
 Ψ_{opak} : 0,076 W/(mK)
 Efficiency class : **phA**

Ventilation system with heat recovery is applicable to any building!

- about 50 ventilation unit certified up to now (100...7000 m³/h)
- see components database at www.passiv.de

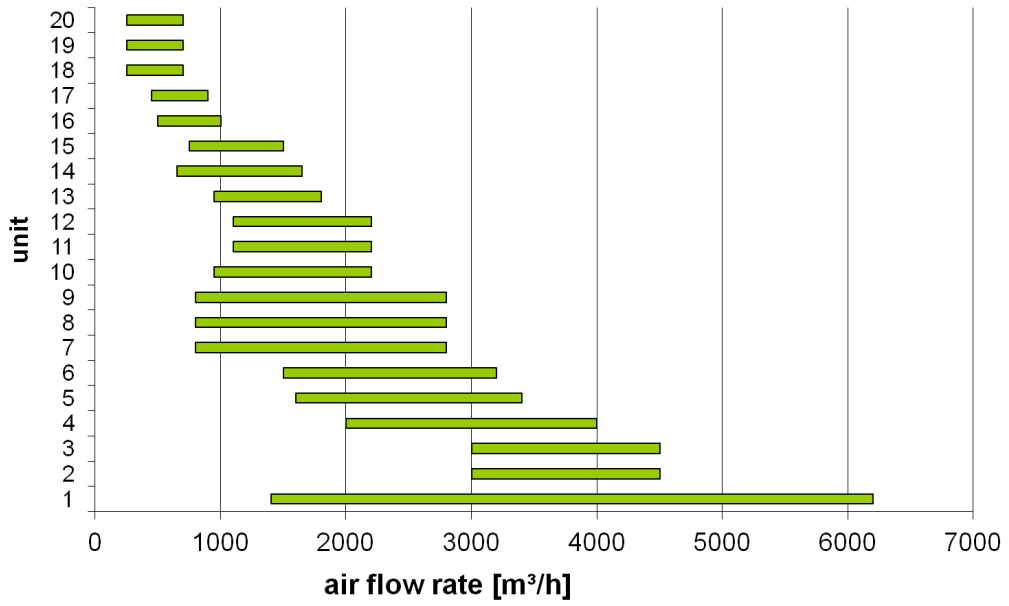
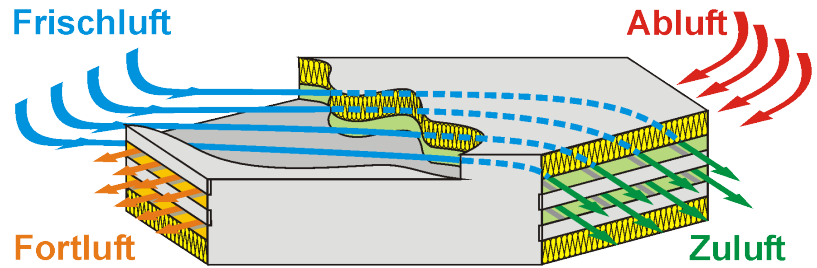
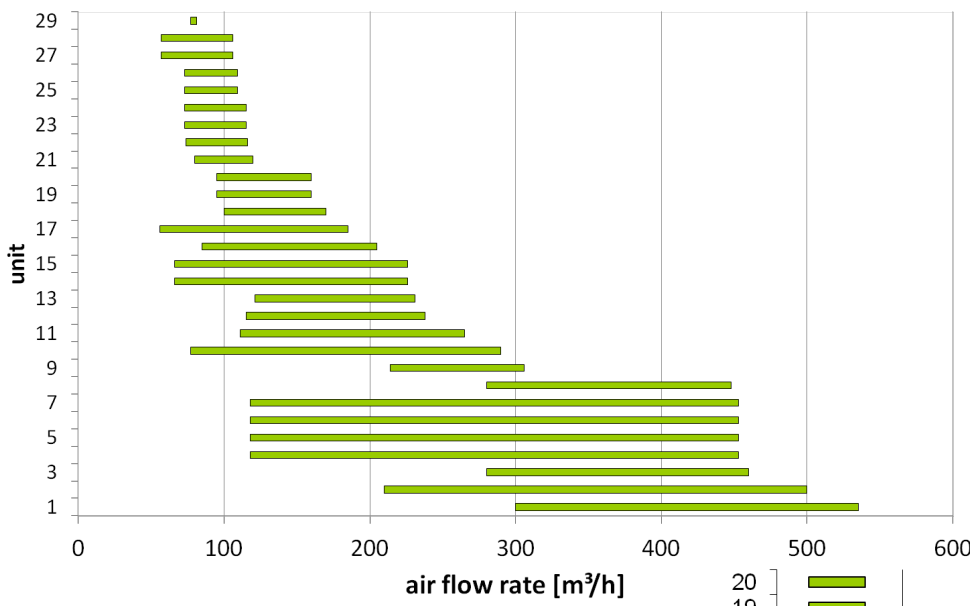

Ventilation system with heat recovery is applicable to any building!

- **Saving of Energy**

heat recovery from exhaust air $\geq 75\%$

low electricity consumption $\leq 0,45 \text{ Wh/m}^3$

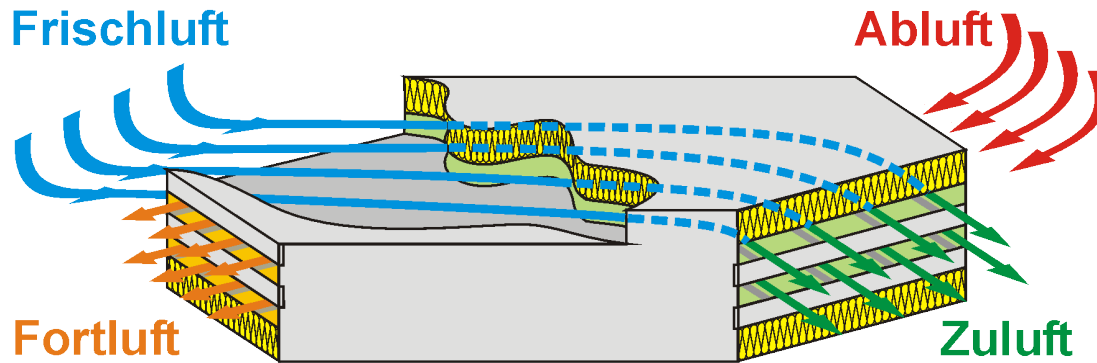

- **thermal comfort**

min. supply air temperature $16,5^\circ \text{ C}$

low noise level: max. 25 dB(A) in living rooms



economic evaluation of governmental office building: low energy 2007 – 2009 and PH

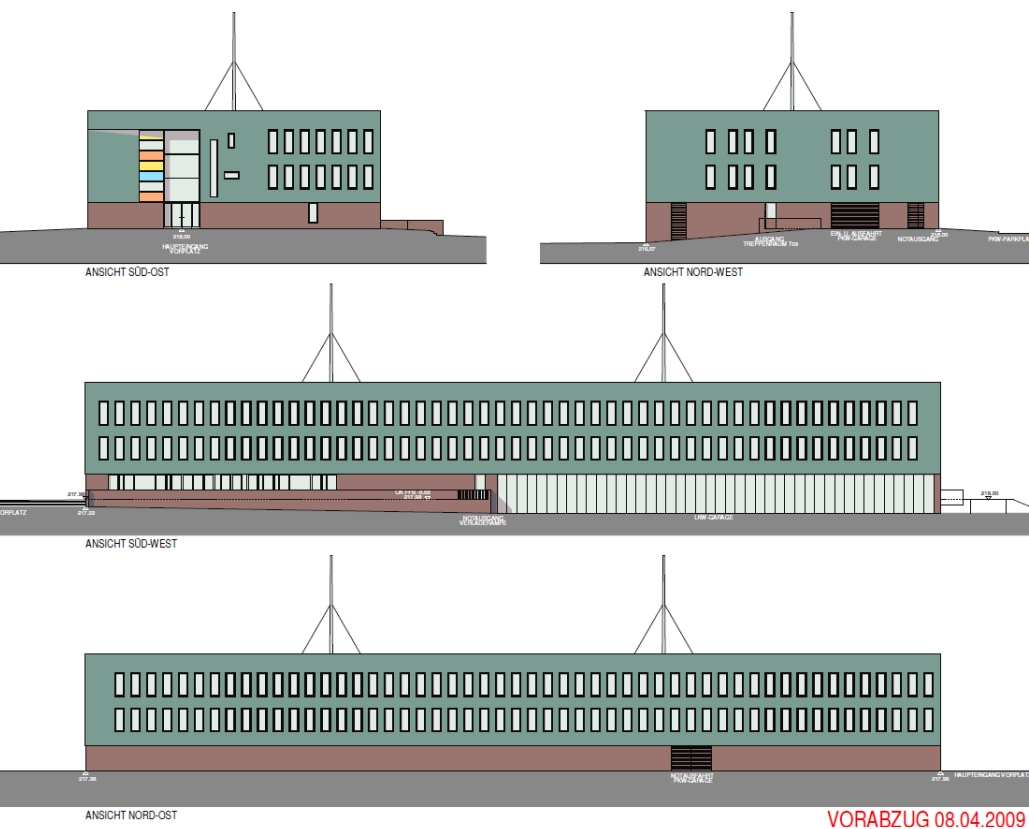

NGF: 4684 m²

NF: 3053 m²

EBF: 3870 m²

source: Passivhaus Institut, Diploma Theses Anne Huse "Ökonomische Evaluierung..." available for download at www.passiv.de

economical comparison for office building

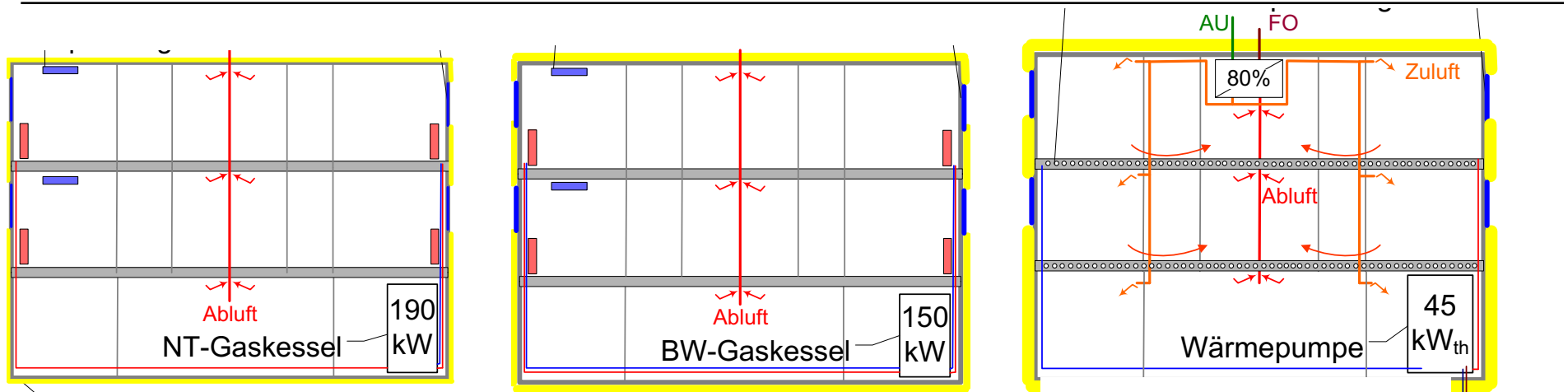

Low energy 2007

- $U_{\text{wall}} = 0.46 \text{ W/m}^2\text{K}$
- 2pane glazing, standard frames
 $U_w = 1.48 \text{ W/m}^2\text{K}$
- Split cooling devices
- Standard gas boiler
- Internal gains: $5,71 \text{ W/m}^2$
- Air tightness: 1,5 /h
- Lighting: $4 \text{ W}/(100\text{lx}\cdot\text{m}^2)$ installed;
- Fluorescent lamps with **VVG**;
- **Without special light design**

Low energy 2009

- $U_{\text{wall}} = 0.26 \text{ W/m}^2\text{K}$
- 3 pane glazing, standard frames
 $U_w = 1.11 \text{ W/m}^2\text{K}$
- Split cooling devices
- Condensing gas boiler
- Internal gains: 5.71 W/m^2
- Air tightness: 1,5 /h
- Lighting: $4 \text{ W}/(100\text{lx}\cdot\text{m}^2)$ installed;
- Fluorescent lamps with **VVG**;
- **Without special light design**

Passive House

- $U_{\text{wall}} = 0.12 \text{ W/m}^2\text{K}$
- 3 pane glazing insulated frames
 $U_w = 0.86 \text{ W/m}^2\text{K}$
- Concrete core activation, ground probes, heat pump (summer+winter)
- Internal gains: $4,77 \text{ W/m}^2$
- Air tightness: 0,5 /h
- Hot water decentralized (electric)
- Lighting: $2 \text{ W}/(100\text{lx}\cdot\text{m}^2)$ installed;
- Fluorescent lamps with electronic starter;
- **With special light design**

see Anne Huse, PH-conference 2010

Investment costs go slightly up ...

- only energy related costs taken into account and shown!

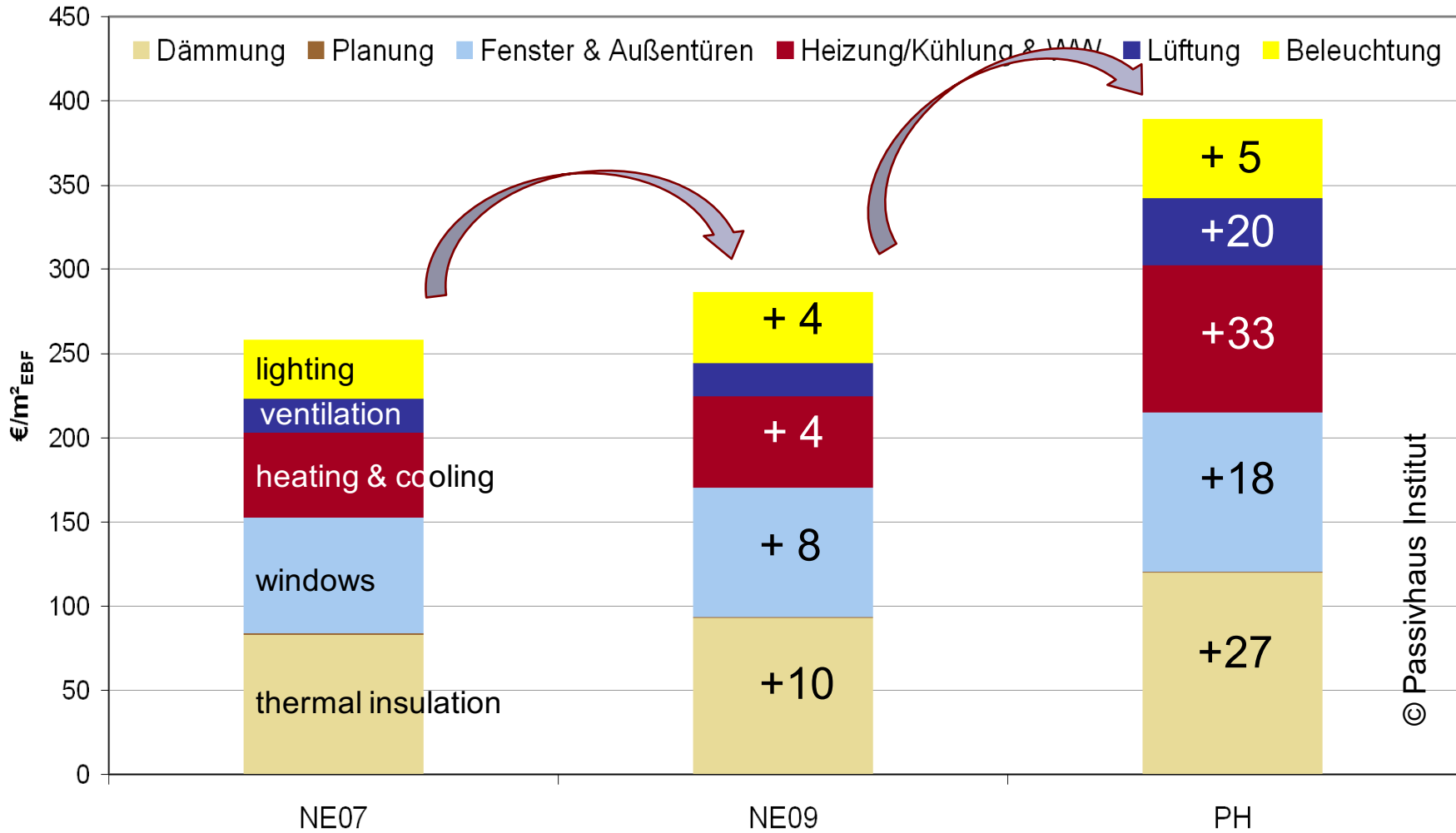

see Anne Huse, PH-conference 2010

... vs annual payments (total costs) reduced

- total lifecycle costs depend on interest rate & energy price

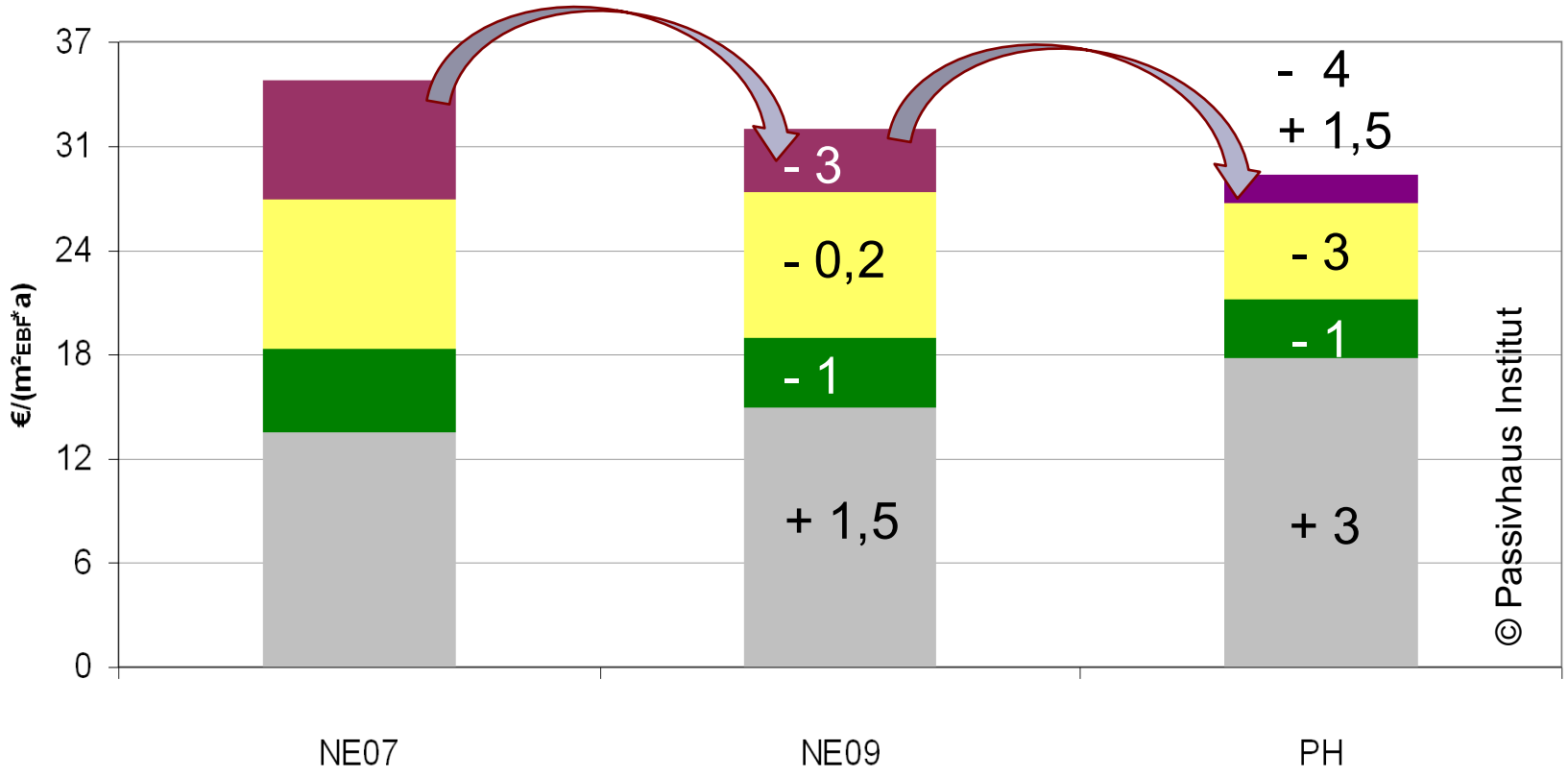

- investment cost (without residual value)
- electricity cost (lighting, cooling...)
- gas for heating
- maintenance cost
- heat pump electricity cost heating&cooling

Summary / Conclusion: Passive Houses are economically reasonable

general analysis and thesis:

- Energy prices and interest rates will probably not be 'high' at the same time

this chance we have to take:

- if energy prices are high, you should avoid high energy consumption(!)
- low interest rates and high energy prices favour the higher investment for better building quality (energy efficiency)
- instead of burning (expensive) fossil fuels.
- hence Passive House (special) or energy efficiency (in general) is a profitable investment

third party advantages (win win win win):

- micro economy: local manufacturer (payed work for many people)
- macro economy: government (more taxes, welfare, ...)
- environment (less CO₂ ...)
- user (higher comfort, less cost that is like an old age provision!)

Conclusions: it's economically reasonable to change.....

What thermal insulation layer is economically reasonable?



... What is the optimal ratio between energy savings and investment costs?

... what is the cost of new paint for the house?

Total cost analysis of thermal insulation layer (ETHICS)

- boundary conditions as in the past (before 2004)

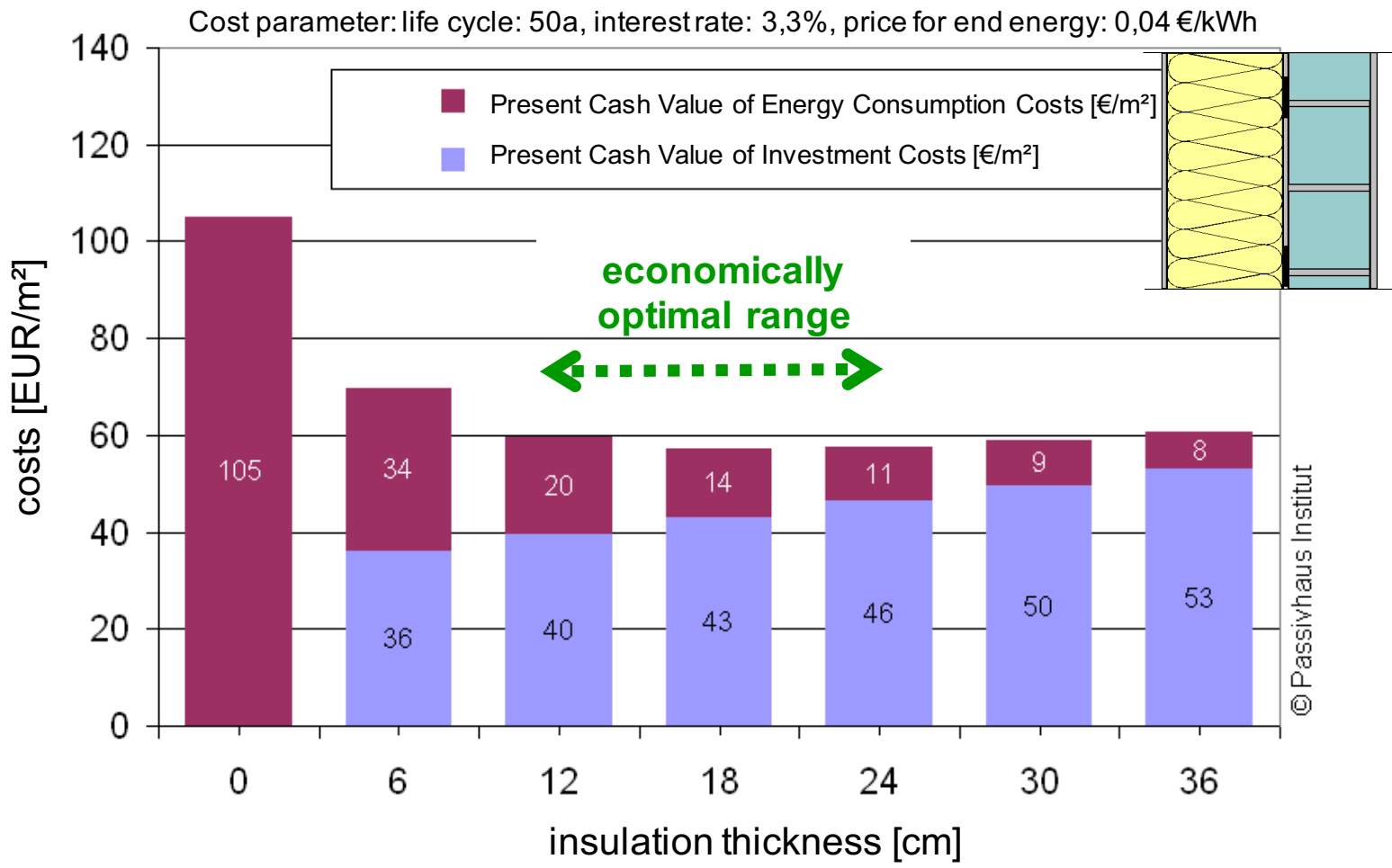

Total cost analysis of thermal insulation layer (ETHICS)

- boundary conditions as reported for german government (BBR 2008)

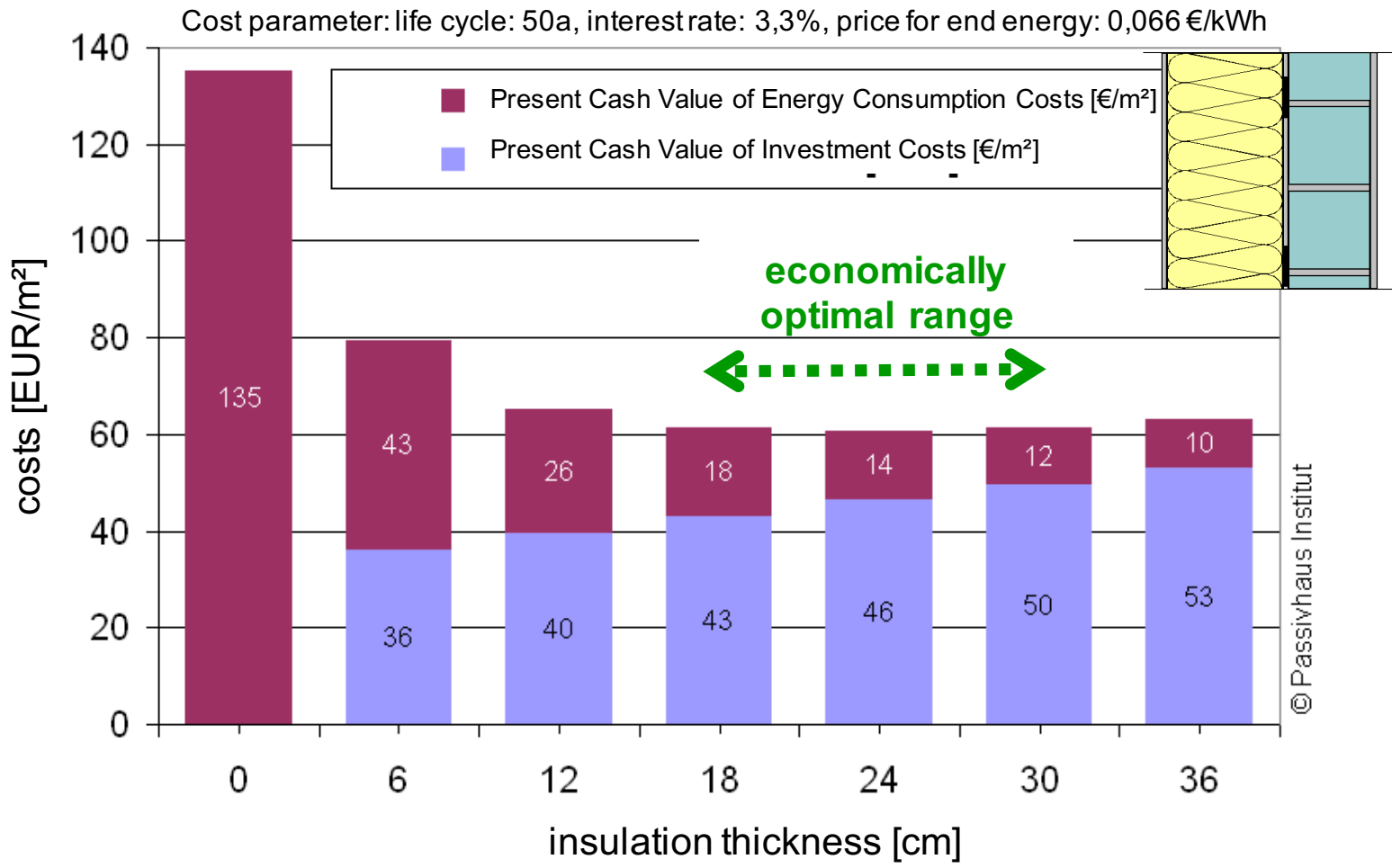

Total cost analysis of thermal insulation layer (ETHICS)

- boundary conditions as today (2012)

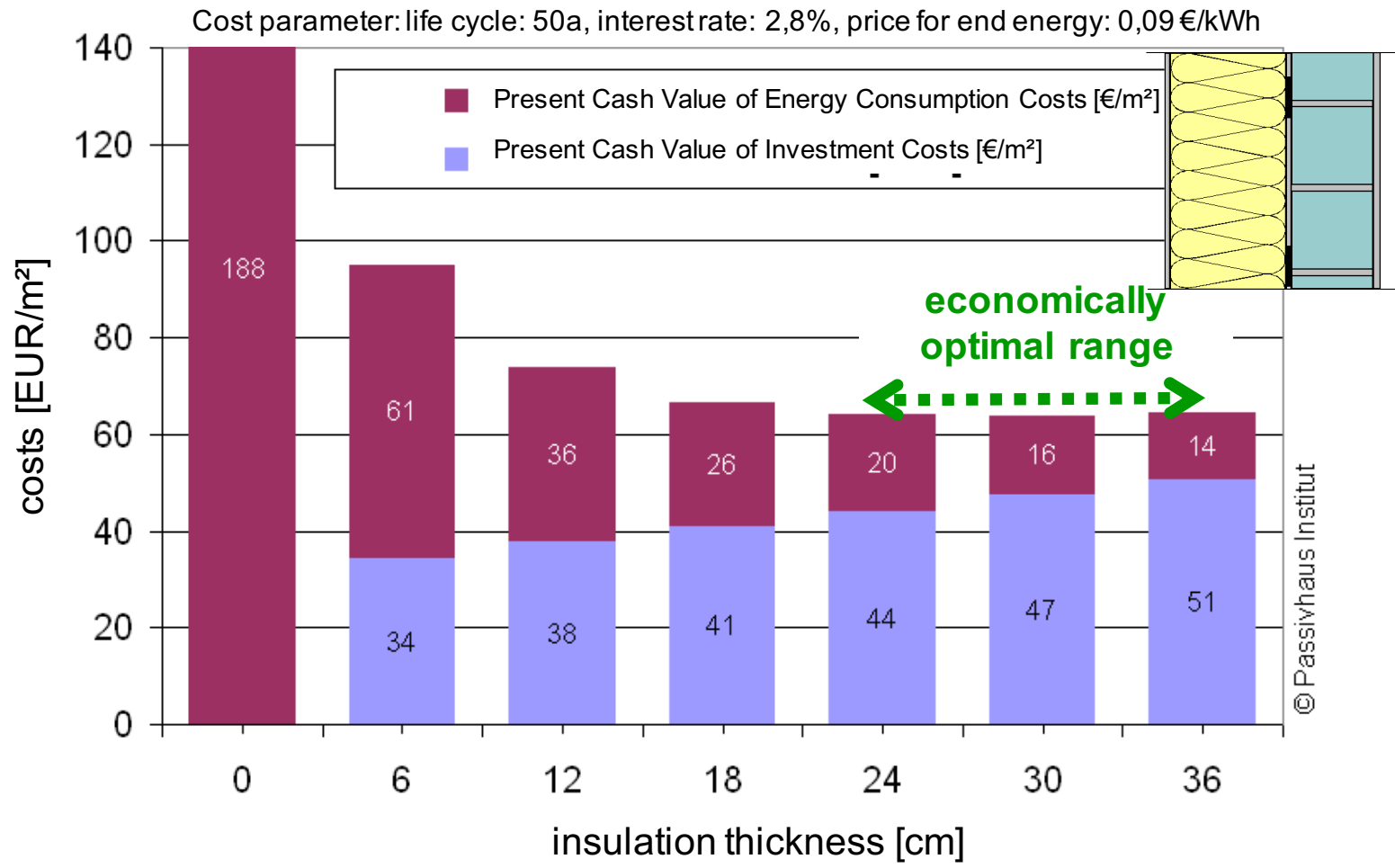

example: cost comparison new built row house

- row house: wooden construction 184 m² (treated floor area)
- rendering outside on wood fiber board
- Windows: 30 m² (plastic) shading of south windows
- district heating
- construction costs (KG 300+400)

1200 €/m²

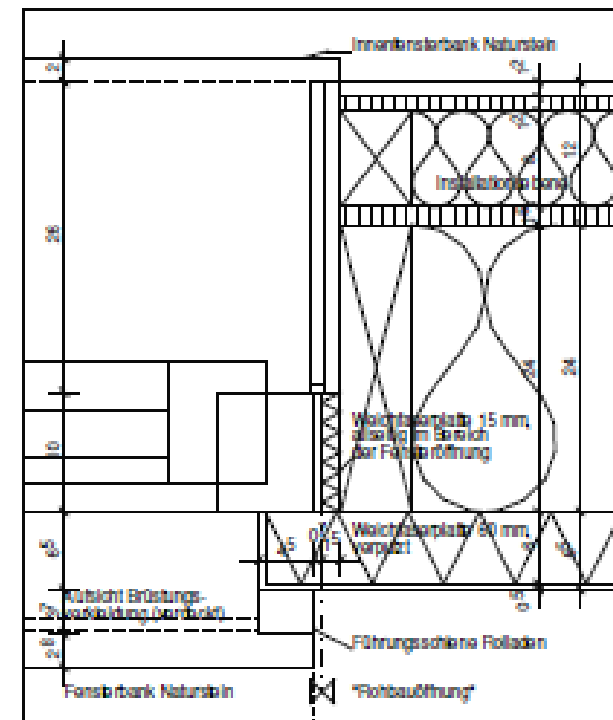

Architect: Zielke, Darmstadt

Costs compared: new built row house

- moderate extra costs for Passive House compared to LEH(NEH)

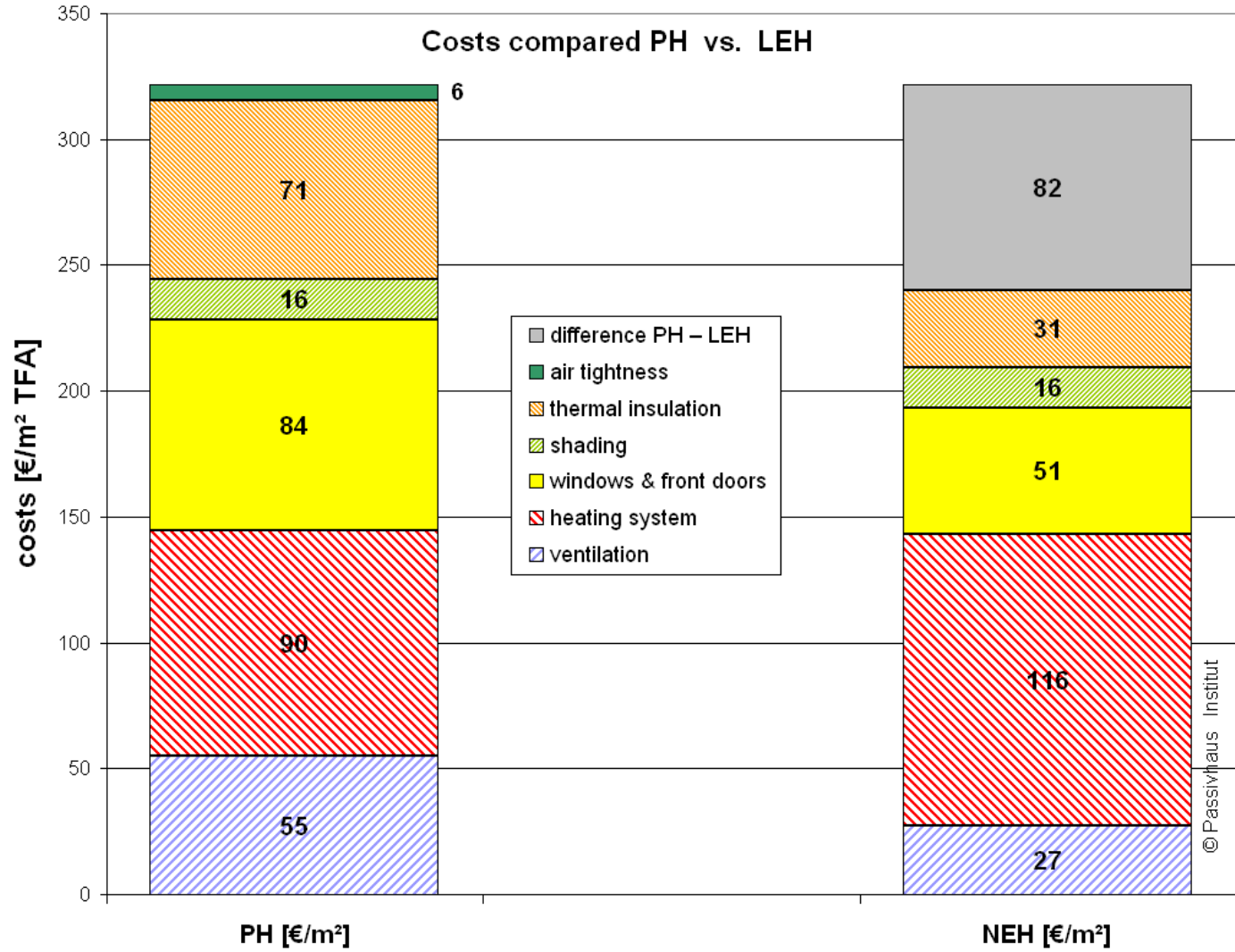

Quelle: AKKP 42 Ökonomie

Passive House compared to low energy building (RMH)

- Energy costs as today (2012):
PH and LEH (NEH) almost equal

RMH: PH vs. NEH + Solarthermie Kredit: 20 Jahre, Realzins: 2.5% Endenergie(Wärme): 0.1 €/kWh Endenergie(el): 0.25 €/kWh

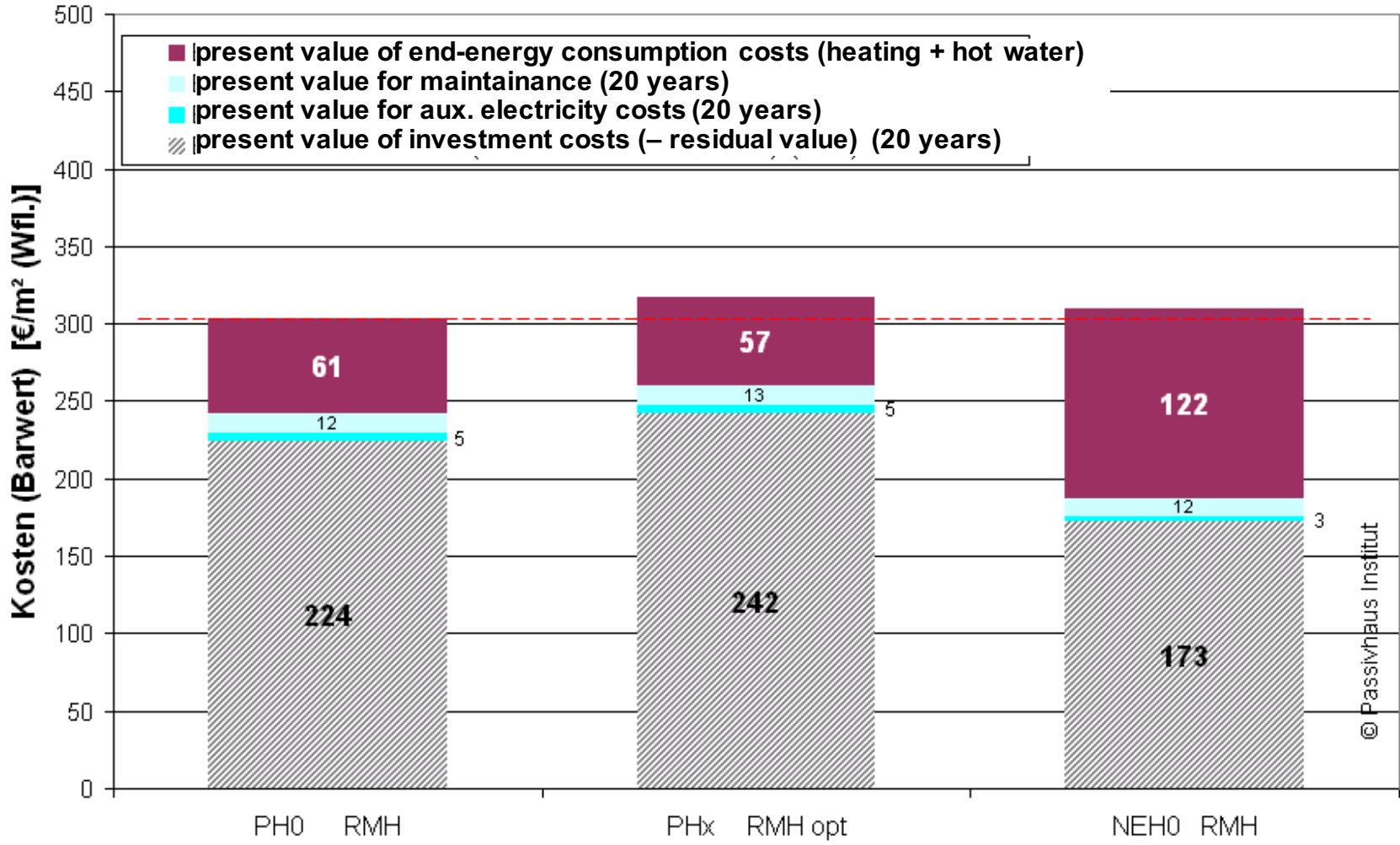

© Passivhaus Institut

Passive House compared to low energy building (Szenario '15cent')

- higher energy prices: significant advantage for PH

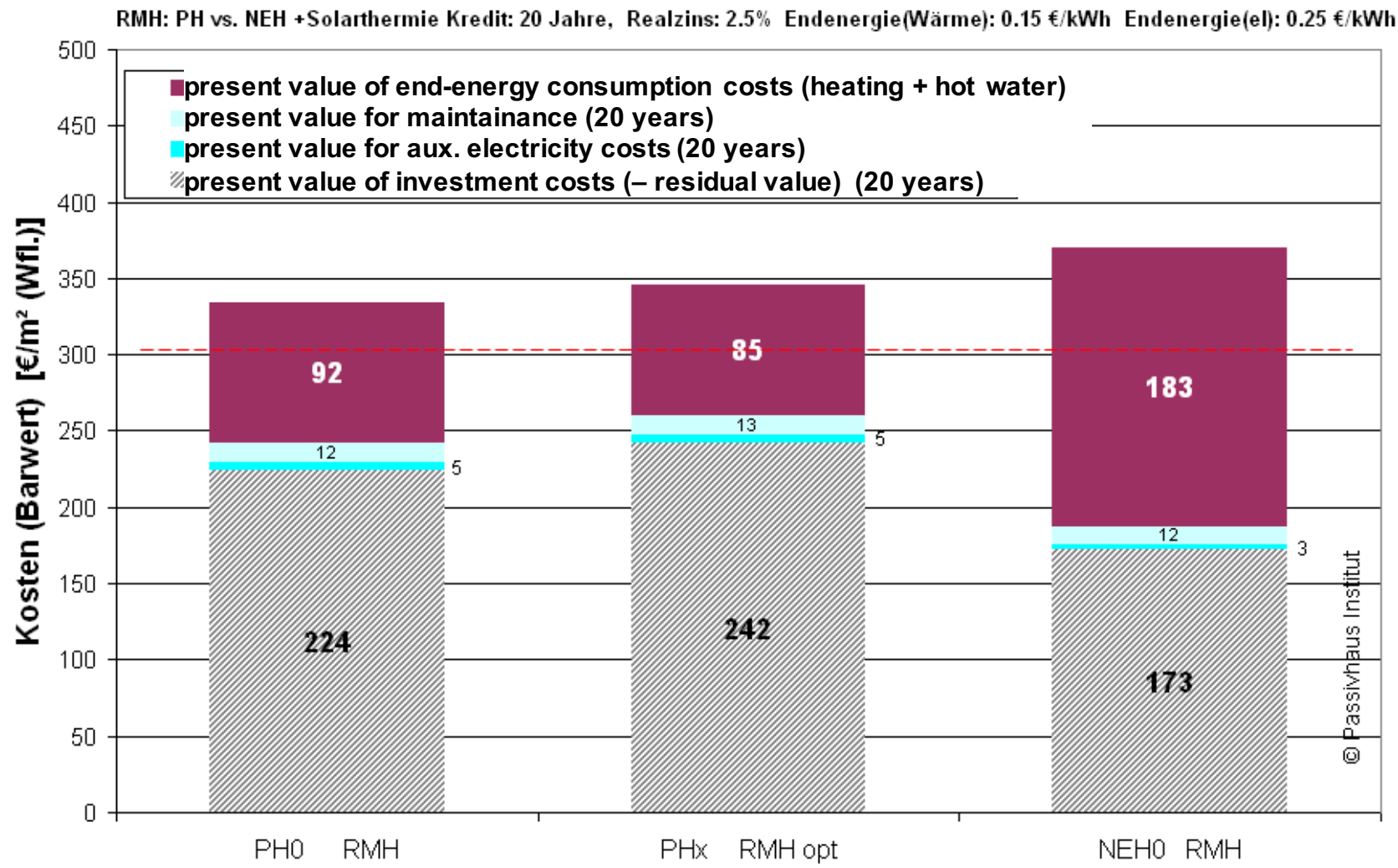

Passive House compared to low energy building

- PH compared to 'low-e'
- ventilation with heat recovery gives significant contribution

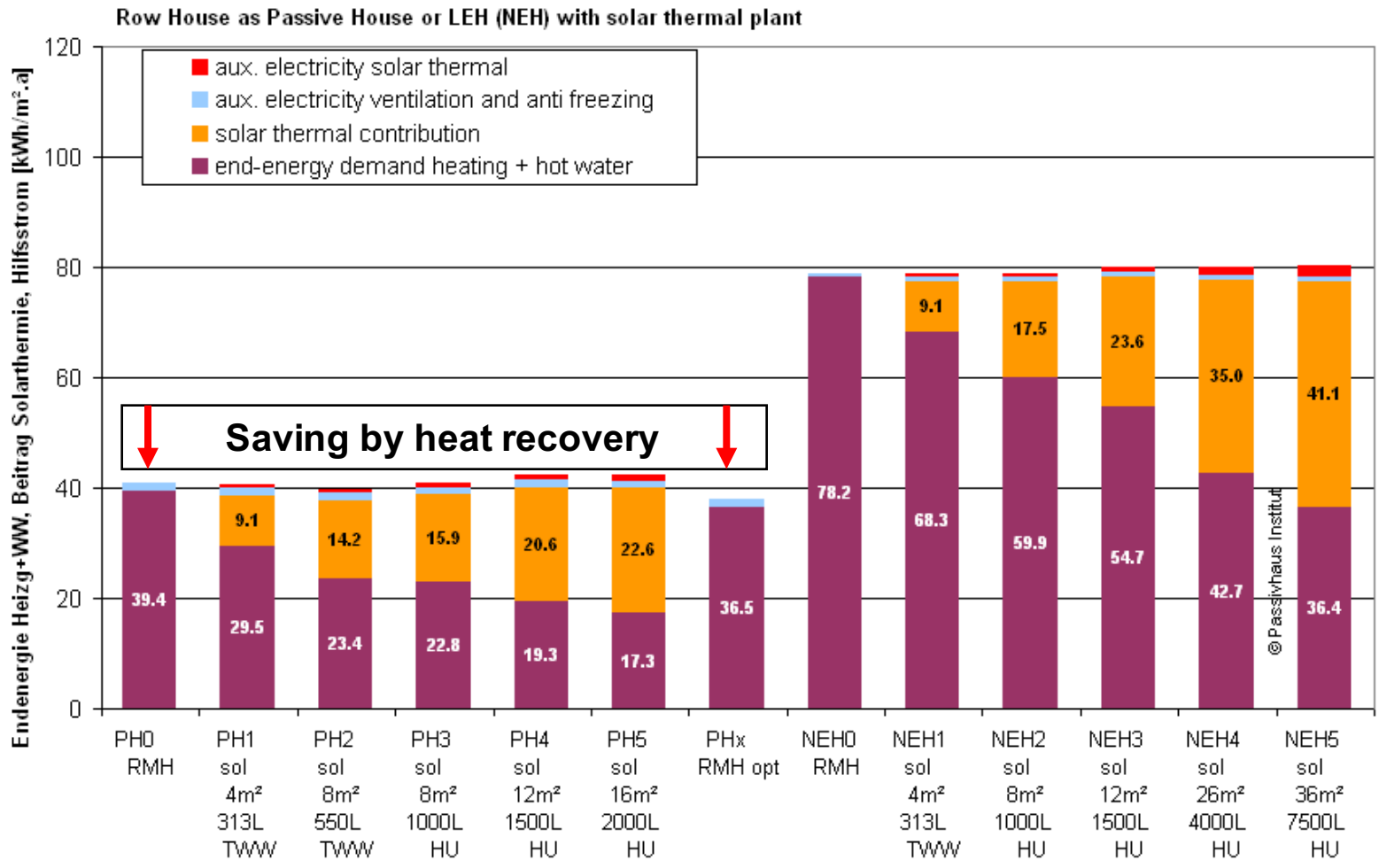

Quelle: Protokollband 42 (Ökonomie) Arbeitskreis Kostengünstige PH

Problem: active solar (renewable) deficit in wintertime

- Solar thermal plants to support heating (HU) need to be very large
- PH3 typical PH with solar thermal plants to support heating
- Low-e-Building: Solar Input needed even larger
- In winter time only part of the demand is covered by solar thermal

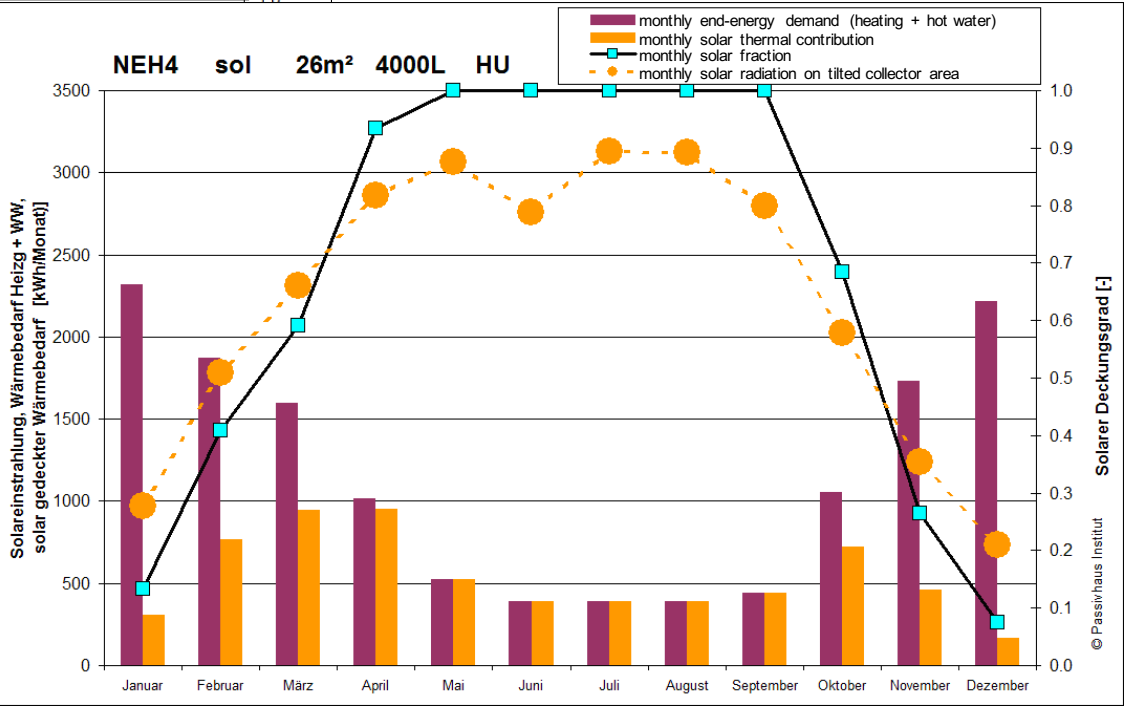
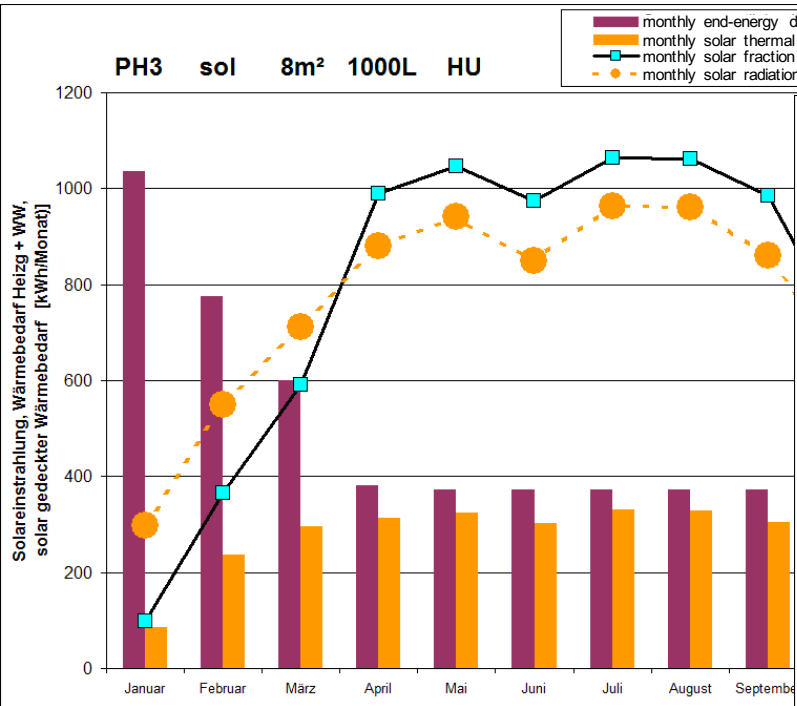

Quelle: AKKP 42 (Ökonomie) www.passiv.de



Problem: active solar (renewable) deficit in wintertime

- Solar thermal plants to support heating (HU) need to be very large
- PH1 small solar thermal plants only for hot water
- PH3 heating supported in spring & autumn



Quelle: AKKP 42 (Ökonomie) www.passiv.de

Problem: active solar (renewable) deficit in wintertime

- Solar thermal plants to support heating (HU) need to be very large
- In winter time only part of the demand is covered by solar thermal

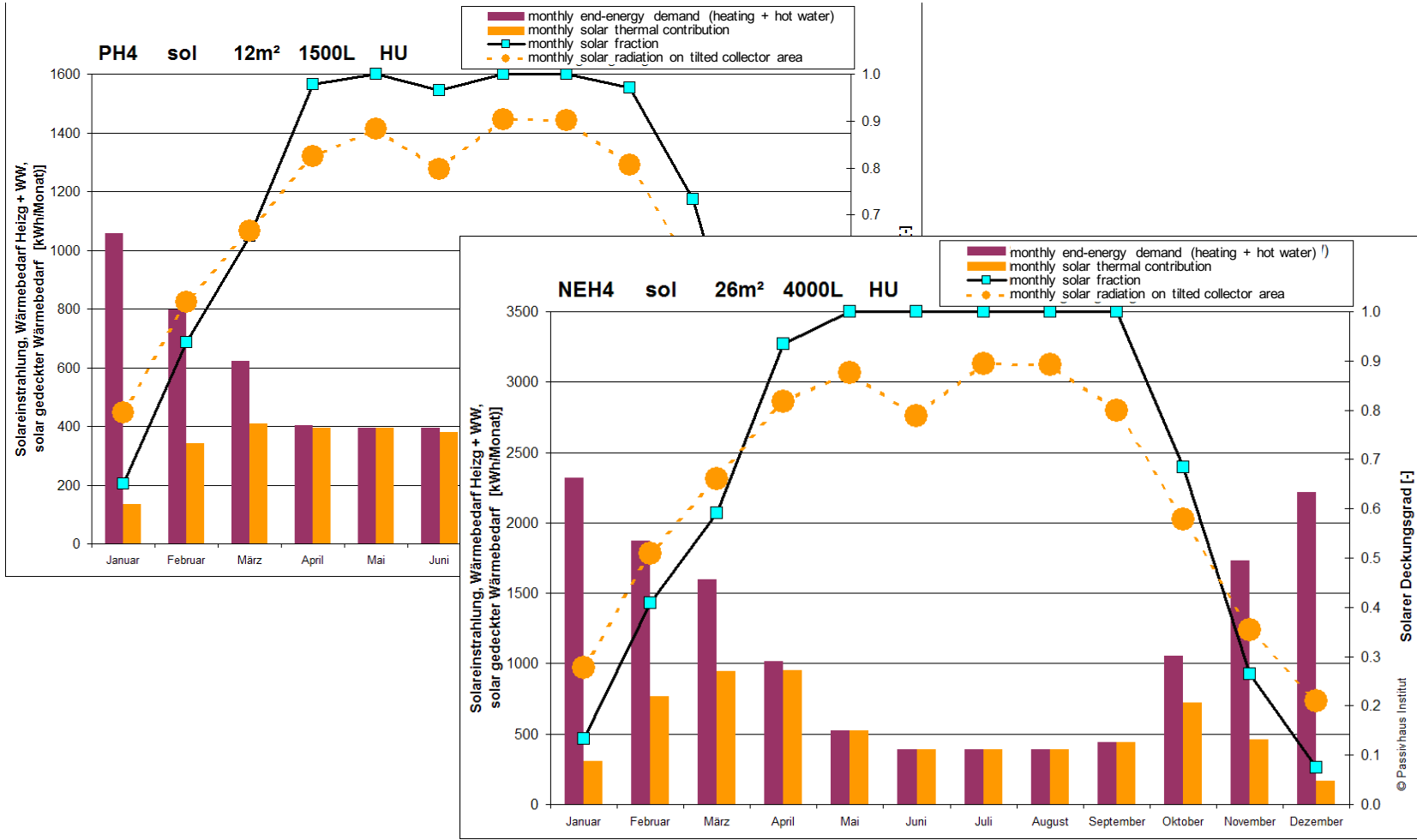

Quelle: AKKP 42 (Ökonomie) www.passiv.de

PH compared to 'low-e' building

- A ventilation system is not that 'expensive'!

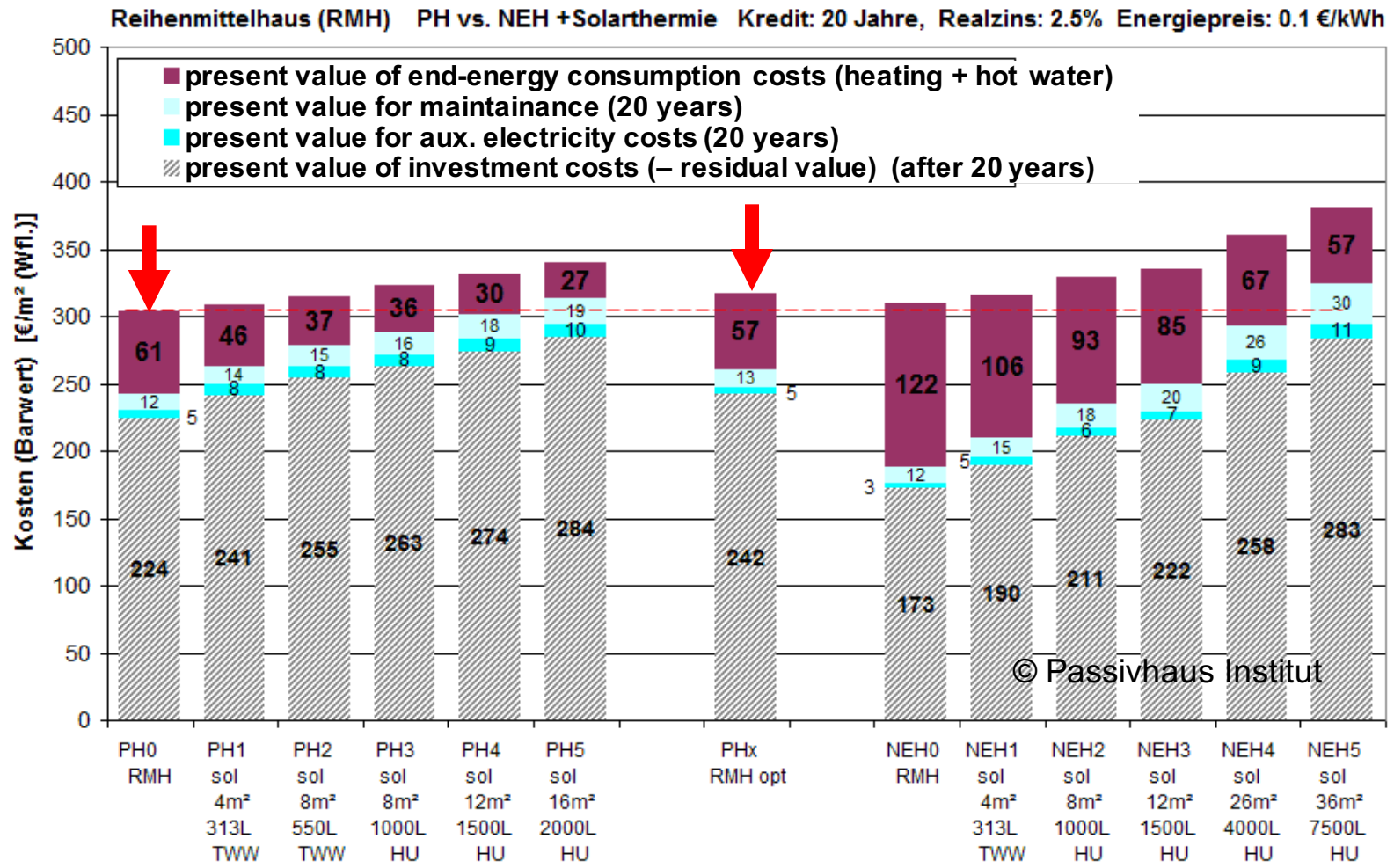

Quelle: Protokollband 42 (Ökonomie) Arbeitskreis Kostengünstige PH

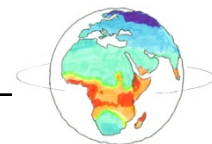

example (building service): concept for cooling and dehumidification

- centralized preconditioning of air (MVHR) combined with dehumidification to 12 g/kg on roof
- decentral heating or cooling to adjust comfortable air parameters with small circulation air heater/cooler in each dwelling (ach: 2/h)
- heat and cold source by water circle: cooled during summer, heated during winter

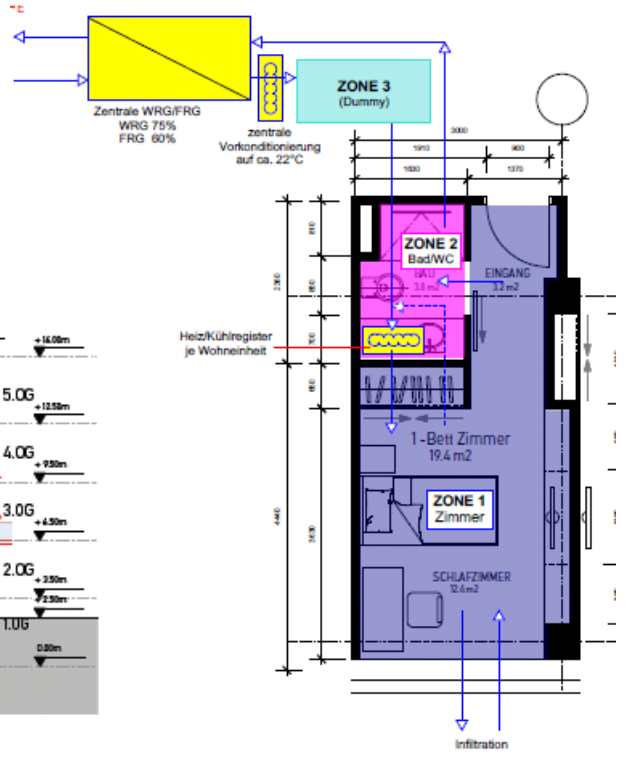
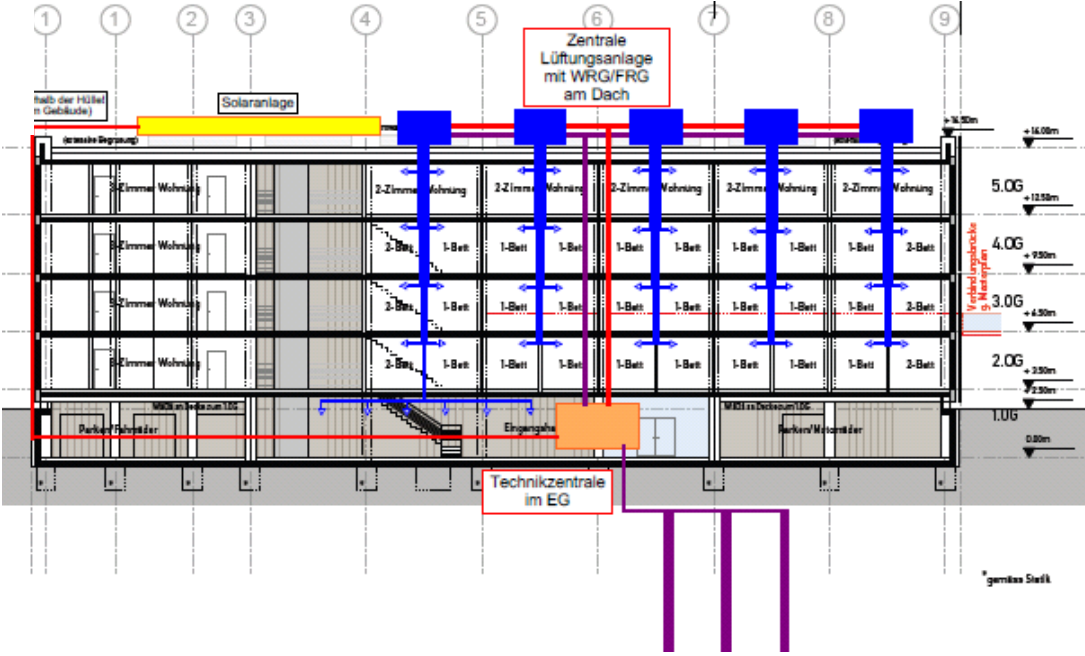
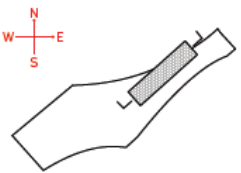

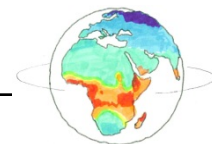

general: deciding factors for comfortable indoor climate

- **Air quality and thermal comfort**
- Comfortable temperature & humidity range
- Reduced radiation asymmetry
- Health (fresh unpolluted air, no mould growth etc.)
- No draughts ...

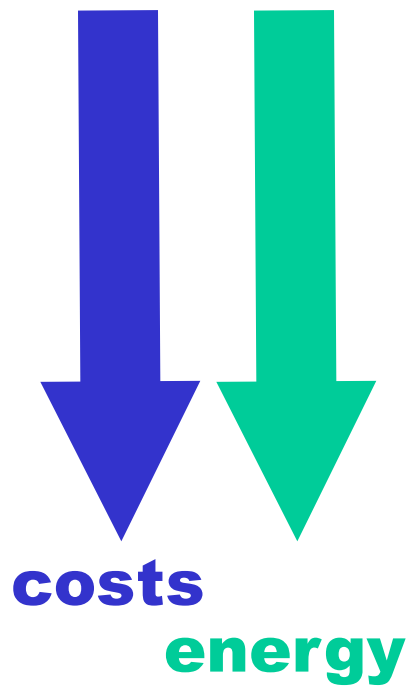
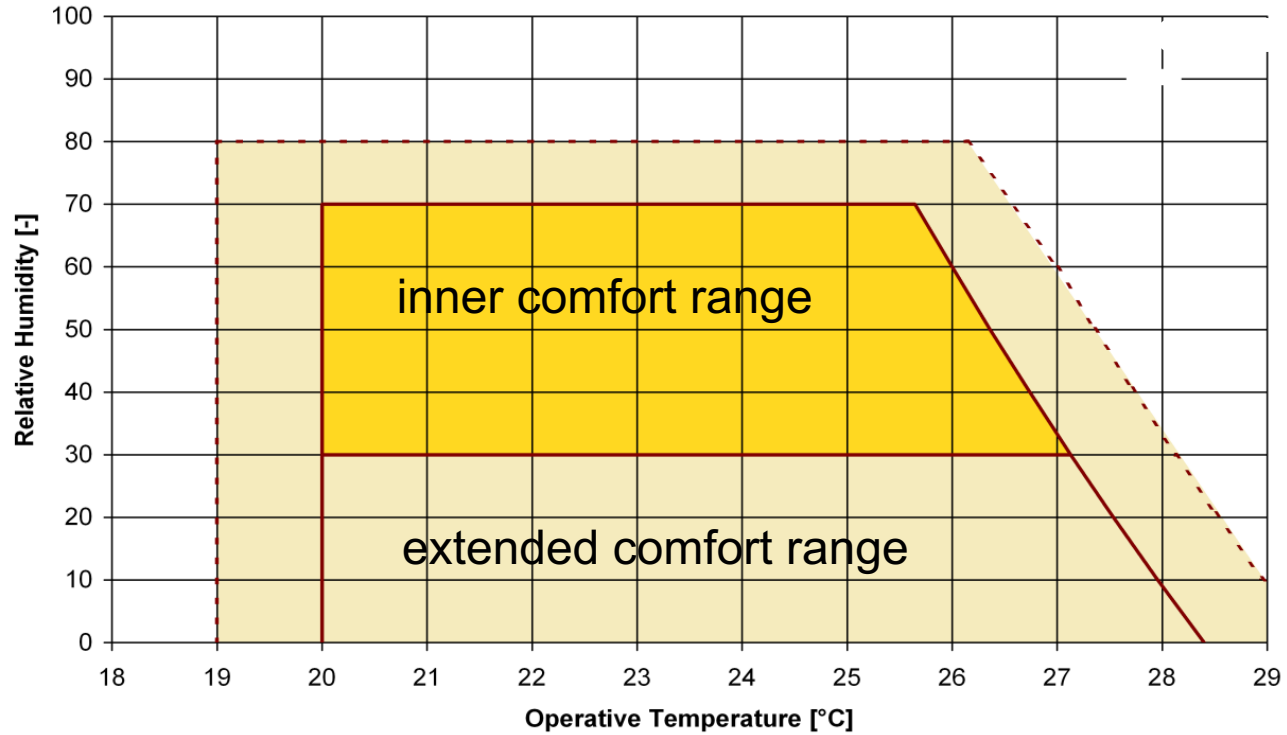

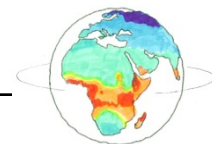

example: the outside climate conditions in Shanghai

- moderate winter temperatures
- **please note: in south of China people are supposed not to heat...**
- very hot & humid summer conditions: July, August, September
- **in spring and autumn 'neutral' outside temperatures**

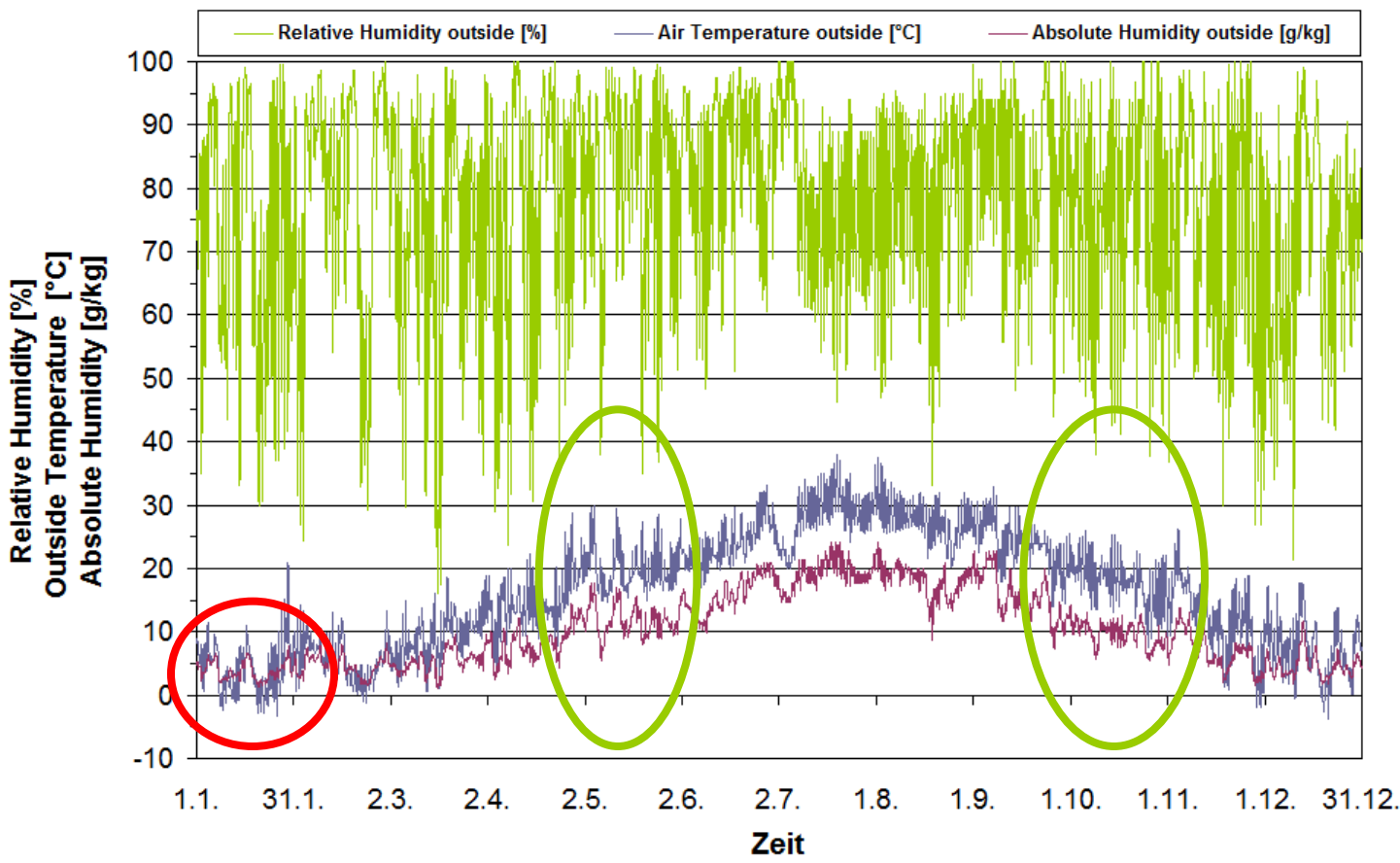

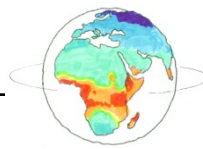

- hot & humid climate: summer cooling (sens & latent) needed
- cooling & dehumidification via supply air is possible
- pure passive operation in spring and autumn, no heating, no cooling

Variante: Wohnung 319umP1WRG075FRG06LT100UT100FH24FB14Uf16g025UW020

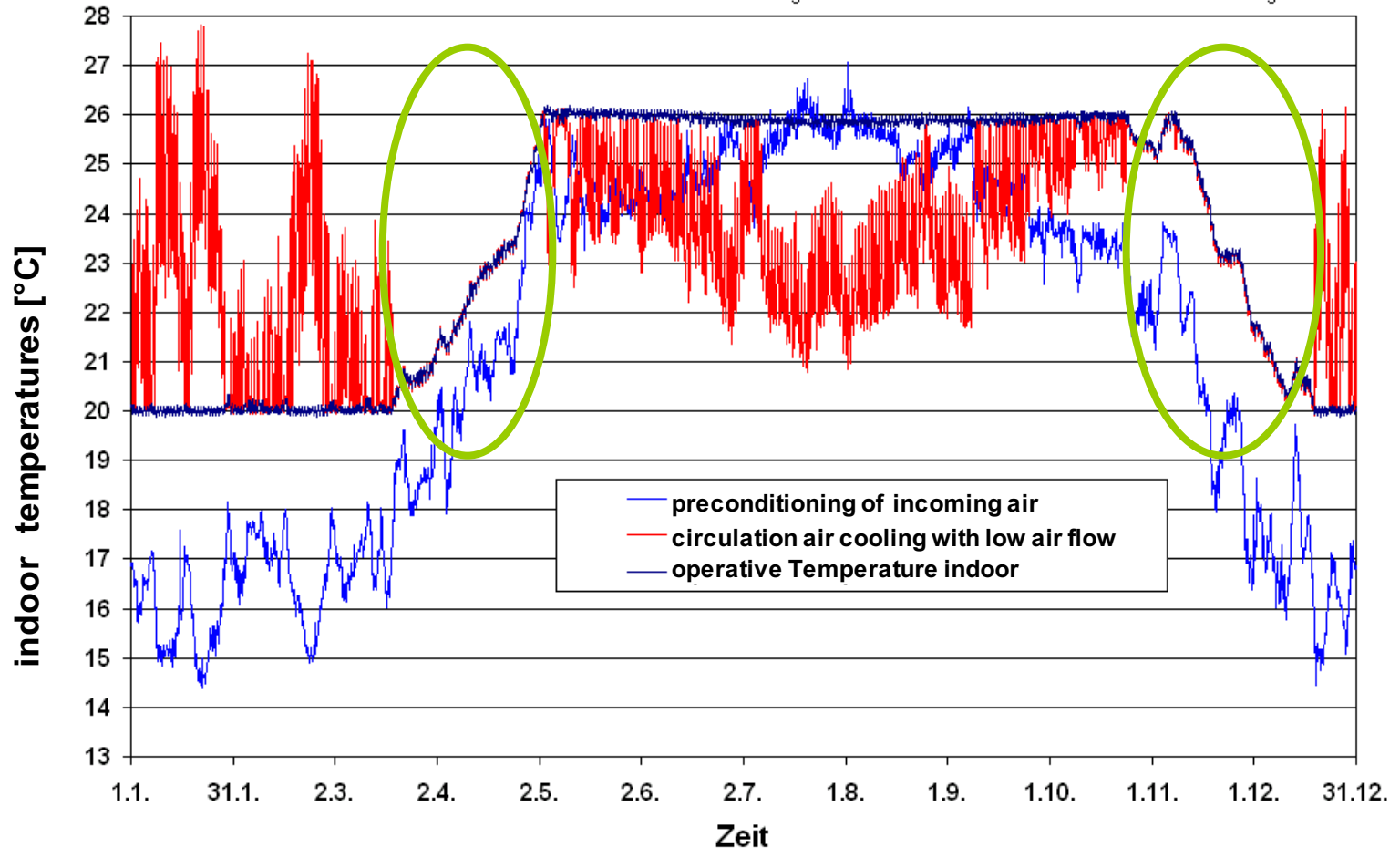

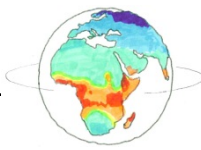

- rotary thermal storage mass (large number of metal lamella)
- lamella transport heat and humidity aerosol to be removed from waste air
- over pressure at outside/supply air side
- flushing chamber to remove all waste air from wheel

advantages

- heat- and humidity recovery are adjustable by rotation speed
- no freezing down to very low temperatures
- low pressure losses

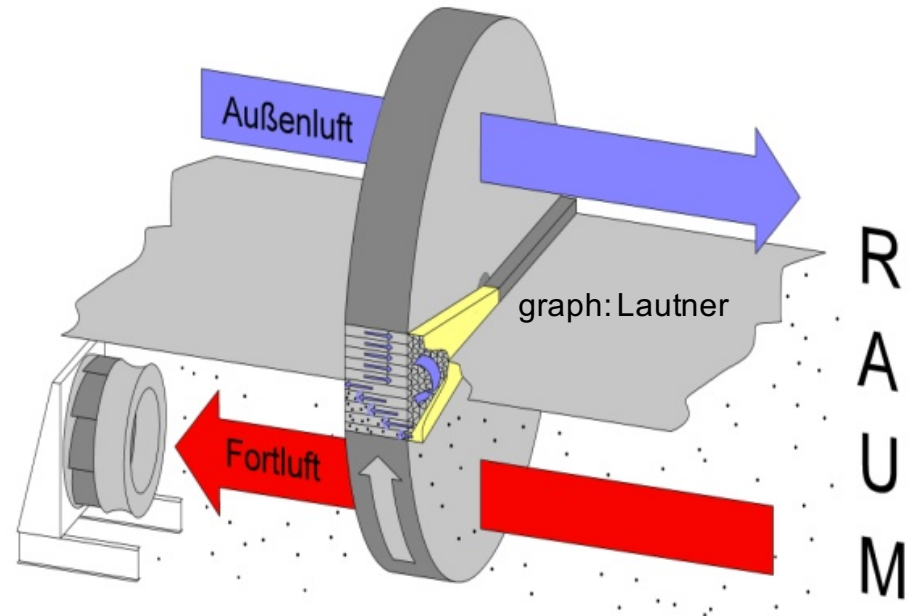
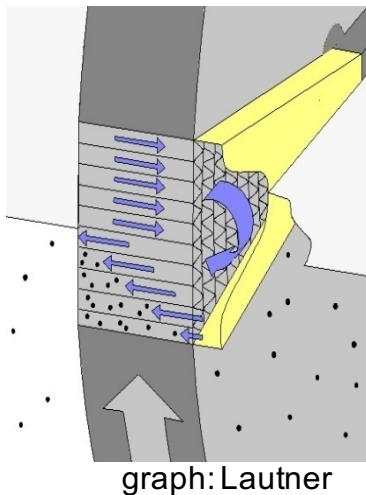

solution 1: active cooling & dehumidification supported by heat & humidity recovery

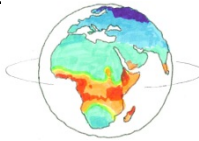

- sorption rotary wheel (1)
- active cooling coil afterwards
- cooled air (humidity <math>< 12 \text{ g/kg}</math>) reheated by condensation wheel (2)
- **seperate cooling and dehumidification is possible:
stop wheel(2) for no re-heating**

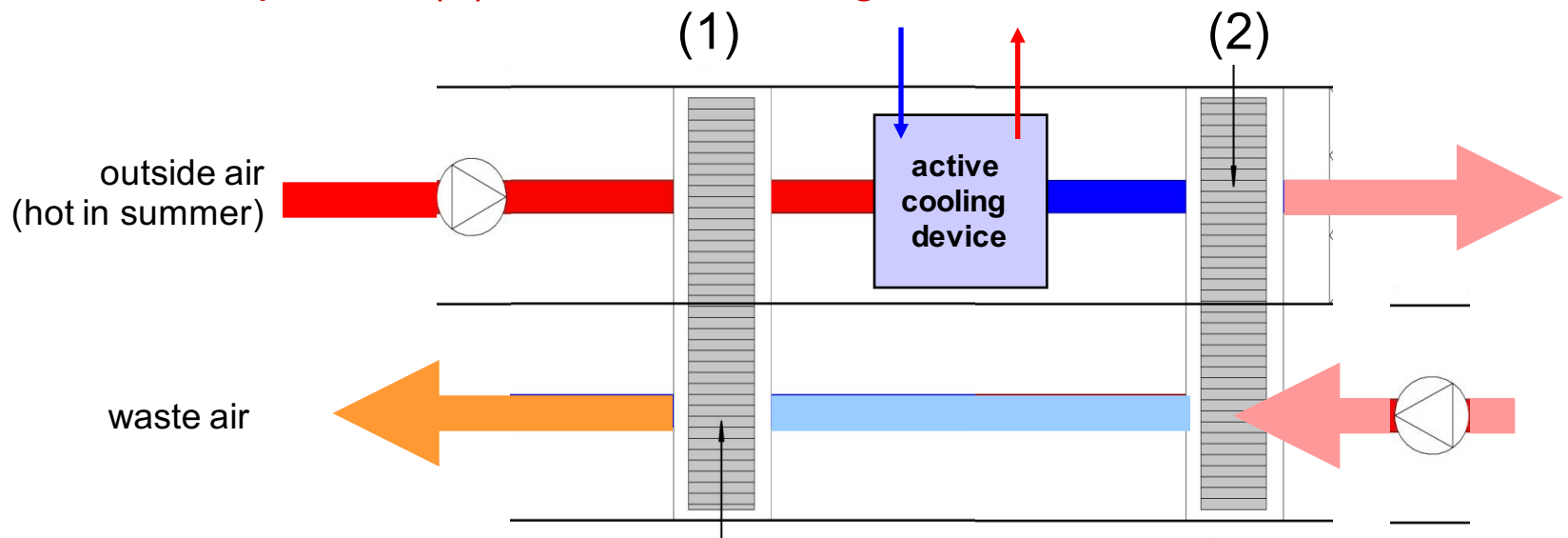

summary: let us just do it!

'deep renovation'

- is much more than 50% reduction with respect to 'old' buildings
- is not that costly as sometimes told
- **best practice experience is yet available**
- is a business with many options

let us just start – there are enough examples ready to learn

the following slides showing the project 'EXPOST', Bozen Italy
Architect: Michael Tribus

If slideshow is too slow because of remote presentation, please have a look to the pdf-copy afterwards at Annex 61 website.



EXPOST

before renovation



MICHAEL TRIBUS ARCHITECTURE

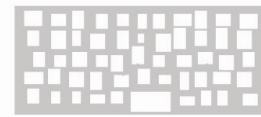

EXPOST

after renovation



MICHAEL TRIBUS ARCHITECTURE

EXPOST

before



MICHAEL TRIBUS ARCHITECTURE

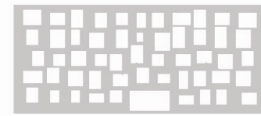

- you must check design for thermal performance!
- inside surface temperatures
- thermal flux (psi-value)

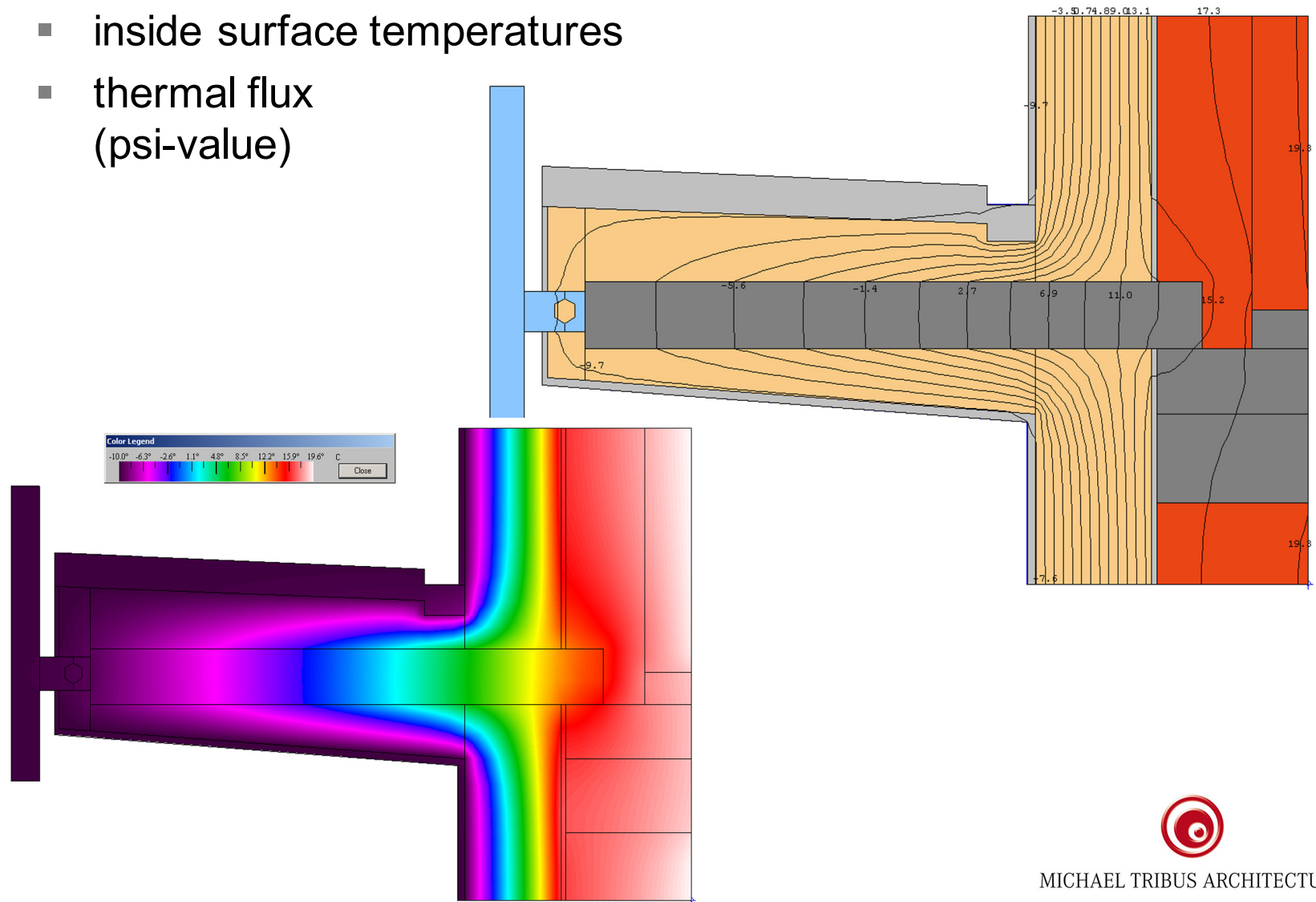

EXPOST afterwards



MICHAEL TRIBUS ARCHITECTURE

due to very low energy demand,
the choice of source for energy is quite free
AND: net zero energy buildings are realistic

- heating & cooling with heatpump & ground coupled probes might be supported by ever cheaper PV-panels
- co-generation / combined heat & power (CHP) reduces primary energy use: waste heat of engine is used for heating
- just keep in mind that PE-factor for electricity is about 3
- reduce internal loads, that pays twice!
- PHPP (Passive House Planning Package) gives advice for the most preferable choice

- further information
- www.passiv.de
- www.passipedia.org
- www.passivehouse-international.org

- Please note the following copyright notice: The present collection of slides was assembled for the participants of the seminar denoted below. This file or any printed copy of this file is for information purposes only and intended only for the personal use of the participants of this event. The transferral of this file to a third party or the right to publish it in any form is excluded. The contents are the intellectual property of the Passive House Institute. In particular, further use of individual contents (slides) is not permitted without the express permission of the Passive House Institute.